

CHALMERS

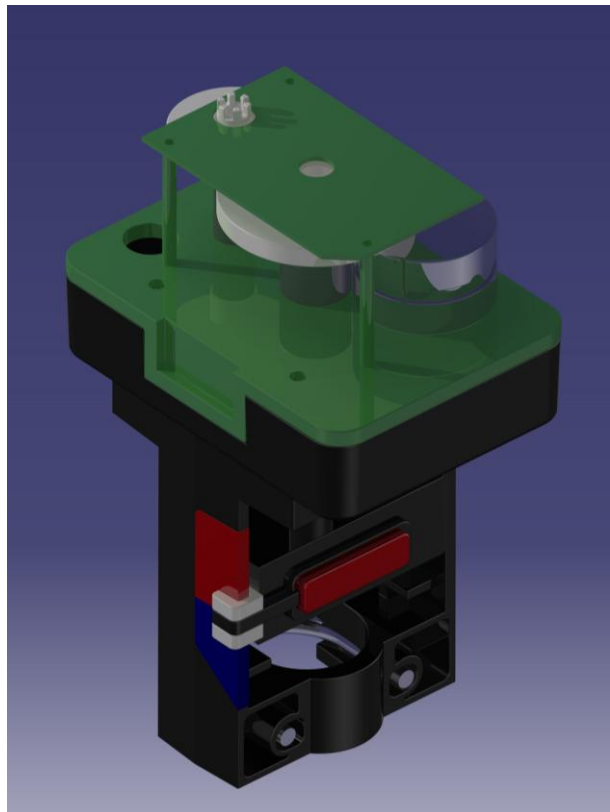
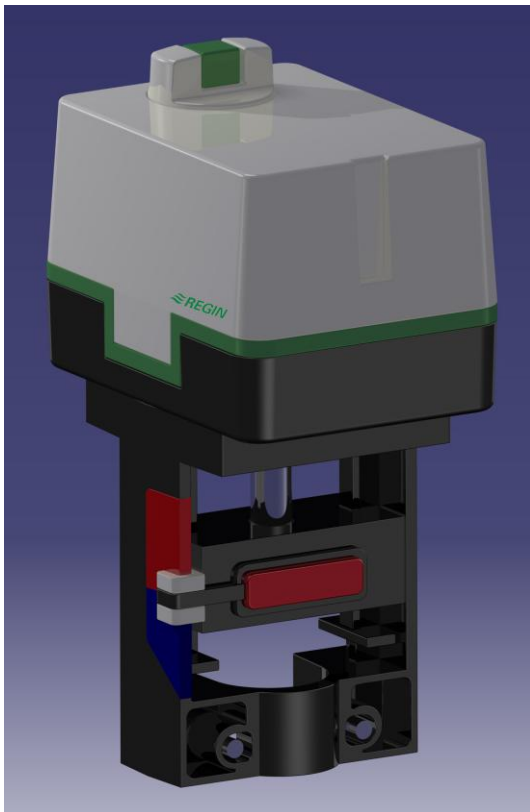

Development of a valve actuator for Regin AB

Master's Thesis in the Master's program Industrial Design Engineering

JENNY ANDERSSON

Department of produkt och produktionsutveckling
Division of Design & Human Factors
CHALMERS UNIVERSITY OF TECHNOLOGY
Göteborg, Sweden 2010

MASTER'S THESIS

Development of a valve actuator for Regin AB

Master's Thesis in Industrial Design Engineering

JENNY ANDERSSON

Department of produkt och produktionsutveckling
Division of Design & Human Factors

CHALMERS UNIVERSITY OF TECHNOLOGY
Göteborg, Sweden 2010

Development of a valve actuator for Regin AB
JENNY ANDERSSON

© JENNY ANDERSSON, 2010

Department of produkt och produktionsutveckling
Division of Design & Human Factors
Chalmers University of Technology
SE-412 96 Göteborg
Sverige
Telefon: + 46 (0)31-772 1000

Cover: Pictures of the new valve actuator done in Catia V5 with and without upper lid.

Department of produkt och produktionsutveckling
Göteborg, Sweden 2010

Development of a valve actuator for Regin AB
Master's Thesis in Industrial Design Engineering
JENNY ANDERSSON
Department of product och produktutveckling
Division of Design & Human Factors
Chalmers University of Technology

ABSTRACT

THIS REPORT concerns a Master's Thesis written at the Industrial Design Engineering Master's program at Chalmers University of Technology in the fall of 2010. The Master's Thesis is made in collaboration with Regin AB, a company specialised in building automation.

THE PURPOSE of the Master's Thesis was to develop a valve actuator. The focus was to design the product in terms of expression and functionality. The project resulted in a realizable product that fitted the Regin product range.

THE PROCESS started with research of valve actuator as well as interview with representatives from the Regin Company. This research resulted in a requirement list that supported the design process and that helped in making a satisfying final solution. Working with various methods and aids for development led to a number of partial solutions to the problem, which was turned into three concepts. The concepts were presented to a group of experts at Regin AB, and in cooperation with that group, the best partial solutions of the concepts were combined to a framework for the final product design.

THE RESULT of the Master's Thesis is a Catia V5 Cad model showing the shape and sized of the different product parts assembled into a complete product solution that meets the requirements stated in the Thesis.

Key words: Product development, Electrical valve actuator, German industry, Branding, Usability, Catia V5 modelling

PREFACE

This Master's Thesis was written during August 2010 to December 2010 as a part of the examination in the Master's programme Industrial Design Engineering at Chalmers University of Technology. I would like to express my regards to my supervisors; Lennart Spiik at Regin AB and Ralf Rosenberg at Department of produkt och produktionsutveckling, Division of Design & Human Factors at Chalmers (who is also the examiner of this Master's Thesis). I would also like to thank Sven Ekered, Research Enigneer at produkt och produktionsutveckling, Division of Produktion system at Chalmers, for the valuable support with Catia V5.

Thanks also to the members of my referents group; Lennart Spiik, Mikael Johansson, Leif Brattsköld, Lasse Bornö, Per Sandström, Jimmy Hallberg, Mark Riccius at Regin AB and Nicklas Eriksson at Allelektronik for giving me valuable input during the project.

Finally I would like to thank all employees at Regin AB, Kållered for helping me with various problems during this thesis work and for making me feel at home and welcome to your company.

Göteborg, Dec 2010

Jenny Andersson

CONTENTS

- 1. Introduction 13
 - 1.1 Regin AB 13
 - 1.2 Task 13
 - 1.3 Purpose..... 14
 - 1.4 Objective 14
 - 1.5 Delimitations 14
 - 1.6 Research questions 14
- 2. Method 15
 - 2.1 Planning..... 15
 - 2.2 Concept development..... 15
 - 2.3 Further development of concepts 16
- 3. Planning phase..... 17
 - 3.1 Background research 17
 - 3.1.1 The Reference group 17
 - 3.1.2 Valve Actuators 17
 - 3.1.3 The use environment 18
 - 3.1.5 Handling..... 19
 - 3.2 Market analysis..... 20
 - 3.2.1 The Market 20
 - 3.2.2 The existing valve actuators..... 20
 - 3.2.3 The Regin valve actuators..... 21
 - 3.2.4 The competitor valve actuators 23
 - 3.3 Branding..... 24
 - 3.3.1 Why a certain character?..... 24
 - 3.3.2 The Regin values and brand 26
 - 3.3.3 The German values and demands 27
 - 3.3.4 Economic justification 28

4. Concept Development.....	29
4.1 Requirements on the new valve actuator.....	29
4.2 Overall design.....	29
4.2.1 Inside components	29
4.2.2 Product Shape.....	30
4.3 Functional solutions.....	30
4.3.1 Lid opening.....	30
4.3.2 Manual adjustment tool	30
4.3.3 The spider locking principle.....	31
4.3.4 Actuator-valve locking principle.....	32
4.3.5 Location scale	32
4.4 The concepts	34
4.4.1 Concept 1a	35
4.4.2 Concept 1b.....	35
4.4.3 Concept 2	35
4.4.4 Concept 3a	35
4.4.5 Concept 3b	35
4.4.6 Concept 3c.....	36
5. Further development of concept.....	37
5.1 Concept evaluation	37
5.2 Final solution	39
5.2.1 Product architecture	39
5.2.2 Subsystems and components.....	42
5.2.3 product assembly.....	48
5.2.4 Material selection.....	50
5.2.5 Check of the demands	52
5.2.6 Economic analyse.....	53
6. Discussion	55
6.1 Discussion of The overall Master's thesis work	55

6.2 Discussion of the cooperation with the different people involved in the Master's thesis	55
6.3 Discussion of the fulfilment of the objectives	56
7. Conclusion	59
8. Recommendation	61
9. References	63
Appendix	
Appendix A - Functional analysis	I
Appendix B - Product board	II
Appendix C - Repertory grid chart	III
Appendix D - Evaluated products	IV
Appendix E - Competitor analysis	V
Appendix F - Regin brand chart	VI
Appendix G - Weighted demands	VII
Appendix H - Early sketches	VIII
Appendix I - Inside components	IX
Appendix J - Shape analysis	X
Appendix K - New spider locking principle	XI

1. Introduction

1.1 REGIN AB

Regin AB is a company specialized in building automation. The company was established in 1947 and is now an important player on the building automation market with a broad range of products and systems that create good levels of indoor comfort. Regin is an international group with head office in Kållerød (Gothenburg), Sweden and representation in about forty countries in Europe, the Middle East and South-East Asia.

The goal of Regin is to offer building automation solutions that contribute to reduced energy consumption and sustainable development (Regin AB, 2010a). The company offers a complete product range – from individual products to comprehensive systems, which are combined to fit the specific client need. The Regin products and systems can be found at museums, hotels, hospitals, water parks, shopping centres, arenas etc, where they save energy and facilitate operation and maintenance in the buildings. The aim of Regin AB is that tenants and anyone working or staying in the buildings always should enjoy a comfortable indoor climate (Regin AB, 2010a).

1.2 TASK

One product category in the Regin product range is valve actuators where Regin AB offers two types; the valve actuators of the RVA series and the valve actuator of the HM1150X series. The valve actuators in the RVA series were developed via a joint venture with a company in Taiwan in 2008, and have since then been sold successfully in most of the active Regin markets. For the German market, Regin AB is manufacturing and selling the valve actuator in the HM1150X series. This series was part of the acquisition of the German company RICCIUS + SOHN in 2008.

The long term plan for Regin AB has been to discontinue the HM1150X series and replace it with the RVA range 230 V models that are under development. The reason is to reduce the numbers of products and models to one valve actuator range to save money and give clearer market design for the company. The goal has yet not been achieved and the reason to this is multifaceted; the RVA valve actuators do not fully manage to fulfil the German requirements on a valve actuator and the introduction of the RVA valve actuators on the German market causes a need of introducing adapters and other connective parts to the existing system to make it fully functional.

The market focus of the Master's Thesis is the German industry since it is least satisfied with the valve actuators of RVA and the reason why Regin AB has to offer two valve actuators. Even if the focus is the German market the demands of the other markets where Regin AB sell their valve actuators are also taken in regard to enable to fulfil the criteria of all the Regin markets.

The task of the Master's Thesis is to determine which criterions the different markets have on a valve actuator, which values the new valve actuator should express to be appealing and which functional attributes that have to be included in the product to make it successful. The new valve actuator should bring something new and modern into the valve actuator product range,

come with a clear design language that matches the Regin design values and be able to stand out from the competing products. Another important aspect is usability and design expression, where the new valve actuator should be easy to use and provide a sense of trust and security to the client/user.

1.3 PURPOSE

The purpose with the Master's Thesis is to, through the development of a new valve actuator, give Regin AB market advantages towards their competitors. The new valve actuator should bring a new look to the valve actuator product area as well as enable for Regin AB to get an even clearer product line and brand. The development of a new valve actuator should also make it possible for Regin AB to offer one valve actuator to all their clients.

1.4 OBJECTIVE

The objective of the Master's Thesis is to develop a realisable product suggestion of a valve actuator that fulfils the demands that is put upon it from an economical, environmental, functional, image/identity, legal, manufacturing, performance, security, technical, usability and working environment perspective.

The Master's Thesis should sort out which design features that appeal to the German market and include these features in the final design suggestion. The aim is to develop a product that is appealing to all the markets where it should be launched, that stands out from the competitor products and that is true to the design values of Regin AB.

The end result should be a product suggestion with ergonomic and design solutions and fundamental mechanical solutions. Suitable material and manufacturing suggestions should also be made together with a ruff economic analysis. The final solution should be presented as a Catia V5 model.

1.5 DELIMITATIONS

- The electronics used in the new valve actuator is not evaluated but kept as it is today.
- The new valve actuator should only be able to mount directly on to the Regin AB valves. For other valves, adapters need to be developed.
- The cable fastening would not be evaluated in this Master's Thesis since Regin AB already has a solution that works in a satisfying way.
- The making of a prototype is not in the frame of this Master's Thesis.

1.6 RESEARCH QUESTIONS

- Which demands do the involved parties (Regin AB, the German industry, other markets, the users of the actuators) have on a valve actuator and could these demands be fulfilled in a single product?
- Are there certain German values for valve actuators and could these be combined with the Regin design values?
- What should the valve actuator products of tomorrow look like?

2. METHOD

Below the different parts of the product development process, performed during the Master's Thesis, are shown.

The Master's Thesis work was based on the Generic product development process of Ulrich & Eppinger (2008). This process consists of six phases – Planning, Concept Development, System-Level Design, Detail Design, Testing and Refinement and Production Ramp-Up. This Master's Thesis ends in the fourth phase - Detail Design.

2.1 PLANNING

“The planning phase begins with corporate strategy and includes assessment of technology developments and market objectives. The output of the planning phase is the project mission statement, which specifies the target market for the product, business goals, key assumptions, and constraints.” (Ulrich & Eppinger 2008, pp. 13)

The Planning phase in this Master's Thesis includes background research with literature studies on how valve actuators work and are used, interviews with various people at Regin AB and with representatives from their co-working companies, visits to the valve development department, valve production and central warehouse in Osby and visits to various buildings where valve actuators are used. A market analysis with benchmarking of competitor products was made to find out what other valve actuators bring to their user, how other companies have solved the requirements put on a valve actuator and how well they succeed in this. All the competitor products found were combined into a product board that helped with the comparison of the competitor products. A competitor analysis was also performed in this stage where the five products that Regin AB saw as their most important competitors were analyzed due to their partial solutions. The valve actuators involved in the analysis were divided into five different categories due to their expression with help of a Repertory Grid chart. The Repertory Grid chart also helped stating which expression the new valve actuator should have to be able to bring something new to the valve actuator market. The planning phase also consisted of a branding part that included an analysis of important design values that should be included in the new product both from a Regin AB and a German industry perspective and also a comparison of the competitors' valve actuator regarding various design aspects.

THE RESULT of the planning phase were a product description, a functional analysis, a description of the usage and handling of the product, a product board, a market analysis, a competitor analysis, the definition of a branding idea and design values for the new valve actuator and an economical justification.

2.2 CONCEPT DEVELOPMENT

“In the concept development phase, the needs of the target market are identified, alternative product concepts are generated and evaluated, and one or more concepts are selected for further development and testing.” (Ulrich & Eppinger 2008, pp.13-14)

The concept development process in this Master's Thesis included the making of a requirement list for the new product, a functional evaluation, sketching and brainstorming of different solutions and ideas and continuous meetings and interviews with concerned people at Regin AB, with representatives from their co-working companies and with representatives from the German market.

One important task in the concept development process was to fit all the inside items, like the motor, the circuit board and the different sprockets, together. The work resulted in a framework of how the inside of the valve actuator should look and how all parts should be ordered inside the product. A minimum size of the valve actuator, called the frame measurements, was also stated and worked as a template in the rest of the design process. The frame measurements were then put into Alias Studio Tool to generate a 3D image of the product framework to make sure that it did not feel clumsy. After this an overall design, true to the Regin product expression, as well as partial solutions to the different problem areas – the spider locking, the actuator valve mounting, the manual adjustment tool and the lid opening were developed.

THE RESULT of the concept development process were three different concepts with partial solution variants, which had the same basic shape but differed in the partial solutions and the added design features. Manufacturing and assembling aspects were also considered in this stage to be able to get an accessible and functional product also for the manufacturers.

2.3 FURTHER DEVELOPMENT OF CONCEPTS

The further development of concepts was based on the faces System-Level Design and Detailed Design stated by Ulrich & Eppinger (2008). The process started with a concept evaluation that helped choose which solutions should be eliminated and which should be further developed. In the following development the partial solutions of most value to Regin AB were further developed and combined into a final product solution.

In the work of creating the final solution material selection and environmental aspects were evaluated. The work also included manufacturing, assembling and disassembly aspects where the aim was to create a product that is easy to manufacture, assemble, use and finally reassemble and recycle.

THE RESULT of the further development of concepts was a final solution presented as a Catia V5 model.

3. PLANNING PHASE

3.1 BACKGROUND RESEARCH

3.1.1 THE REFERENCE GROUP

During the background research, and during the whole Master's Thesis work, interviews and discussions were made with the following people at Regin and their co-working companies, referred to as the Reference group:

- Lennart Spiik, (Development and Technology manager) at Regin AB Kållerød. Responsible for product development
- Mikael Johansson (Product manager) at Regin AB. Responsible for the actuator product area
- Leif Brattsköld, (CEO and Marketing manager) at Regin AB Kållerød. Associate and responsible for market and branding
- Lasse Bornö, (Corporate Sales Manager) at Regin AB Kållerød. Work with sale related questions, attend fairs and sells the product
- Per Sandström (Valve development engineer) at Regin AB Osby. Designer of valves
- Jimmy Hallberg (Valve development engineer) at Regin AB Osby. Actuator tester and designer of actuator and valves
- Mark Riccius (Managing Director and Product sales manager heating) at Regin AB, Germany. Associate and responsible for the German market. Share holder (minority share) of RICCIUS + SOHN.
- Nicklas Eriksson (Production manager) at Allelektronik. Responsible for the production and repair of the "German actuator" HM1150X

The reference group was formed to make it possible to gather opinions and information from concerned people of different working fields – sales, project development, construction, marketing, testing, user contacts etc. The members of the reference group were interviewed several times during the Master's Thesis work in order to determine the requirements put on the valve actuator from different perspectives and to get the opinions from everyone of the progress and results in the different project phases.

3.1.2 VALVE ACTUATORS

"The primary function of an actuator is to control the position of the valve moving element; gate, plug, ball, butterfly, etc; between "open" and "closed" to ensure correct control of the process fluid. To do this the actuator must be sufficiently powerful to produce positive, accurate and rapid response to a control signal and be able to return the valve to a suitable predetermined position in the event of signal failure." (Nesbitt 2007, pp. 285)

There are a lot of different actuators available on the market. The type of valve actuator that Regin AB produces is a direct electrical valve actuator with linear-reciprocation geared for linear motion (Nesbitt 2007). The valve actuator of Regin AB is adapted for control valves in building automation which mostly involve valves for hot or cold water.

To determine the functions of the valve actuator a functional analysis were made where the main, partial and support functions of the product were stated. The result of this analysis can be seen in appendix A – Functional analysis.

3.1.3 THE USE ENVIRONMENT

The valve actuator is often positioned on a valve in a valve system up in the ceiling (see figure 1 *Valve actuator positioned in the ceiling*) or on the floor (see figure 2 *Valve actuator positioned on the floor*).

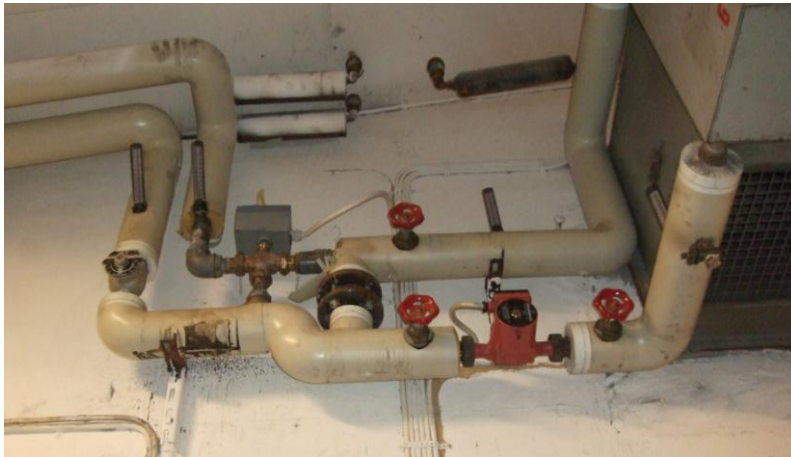

Figure 1 *Valve actuator positioned in the ceiling*

3.1.4 Usage

One application where valves and actuators are used is long-distance heating networks. The heating network controls the indoor temperature in the connected buildings by enable or disable water to flow into the buildings as the inside temperature rises or goes down. The valve actuator is the control devise of this process. The valve actuator receives electrical signals that tell it either to open or to close the valve it is connected to. As the valve actuator open a valve, warm water starts flowing into the valves until it reaches a heat-exchanger where the water is transformed into heat and helps raise the temperature inside the building.

As the same type of valve actuator can be used with different kinds of valves the connection between the valve and the actuator needs to be adaptable to the different cases. Today this problem is solved by adding a specially made adaptor that serves the needs of the current situation.

Depending on which inside temperature that should be generated, the water in the valve take different temperature. Usually the water has a temperature of 100 degrees Celsius but in the



Figure 2 *Valve actuator positioned on the floor*

worst case scenario it could be 120-140 degrees Celsius. To be fully functional the valve actuator has to be able to function properly regardless of the water temperature. The risk with the heat from the water is that it also heats up the valve and valve actuator. The electronic components such as circuit board, motor and electric cables are located at the top of the valve actuator and if the heat reaches this part the whole system can be damaged. Because of this all the sensitive parts needs to be placed on a proper distance from the valve or/and have a connection with a shape and material that helps deflect the heat before it reaches the sensitive parts of the valve actuator. Another thing that affects the action of the valve actuator is the conditions stated by the surroundings. The surrounding can be warm or cold, dry or moistly and clean or dirty and the valve actuator needs to be able to do its job under all these conditions.

The valve actuator could either control the valve system alone or in cooperation with another valve actuator that controls a different valve in the same system. For the valve actuator to be functional electric cables needs to be connected to it. For a single valve actuator mounting there is only need of one electric cable but when you should connect two valve actuators you need to add a second cable. The valve actuator therefore needs to have two cable entrances in order to function properly in all conditions. The cable entrances needs to be closed and not let in dust or moist.

3.1.5 HANDLING

The valve actuator is normally stuck in one location after it has been mounted onto the valve. The manual use is therefore mostly in the mounting face when the valves are installed in the building. After the installation you count on the valve actuators to do their job for at least 10 years time without any surveillance other than checking if they are active or not.

The installation of the valve actuator is done by a plumber; a professional and expert in the valve-area who have much experience in the specific field. If something fails after the mounting is completed the service is usually done by an electrician. (S)he is not as familiar with, and does not have as much experience on valves and actuators, and (s)he therefore has a need of a simple and intuitive valve actuator that is easy to trouble shoot and serve.

An important aspect when it comes to the handling of the valve actuator is that it needs to be easy to determine whether the valve actuator is open or closed. Today both valve actuators in the Regin product range have red and blue plastic markers that show the maximum and minimum value of the stroke length made by the valve actuator and the current location of the valve actuator. These markers do only work when they are correctly positioned in the mounting. This result in a human error threat where the installer may forget doing this manual adjustment and the maximum and minimum values of the stroke length become incorrect and misleading. Another problem with the markers is that they have no scale attached to them. This rule out the possibility for the user to determine whether the actuator is opened or closed which also helps determine if the systems works or not. This problem is observed by Nesbitt who proclaim that “*An indicator should always be fitted if the state of the valve cannot be obviously judged.*” (Nesbitt 2007, pp. 292)

To be able to get a proper output value of the existing valve actuators on the market, the users are forced to paint an own scale onto the valve actuator. The user demands on this scale,

except that it should show the state of the actuator, is that it should be clearly visible from any location where the actuator could be placed; on the floor, up in the air or deep inside a valve network. Since the valve actuator is adjusted when mounted and can have different zero point depending on what the valve it is attached to, the zero point of the scale needs to be adjustable.

Another problem with operation of the RVA valve actuators is that the engine that closes the valve generates a force of 300 KN. The repulsive force causes wear in the connective parts between the valve and the valve actuator and threatens to break the spider locking mechanism and valve-actuator connection.

3.2 MARKET ANALYSIS

3.2.1 THE MARKET

Regin AB sell their valve actuators in Europe, Middle East and South-East Asia. The market of certain focus in this Master's Thesis is the German market as they are the market that Regin AB wants to satisfy the most with the new valve actuator.

3.2.2 THE EXISTING VALVE ACTUATORS

To evaluate the existing valve actuators a market analysis were made. The aim with the market analysis was to find a hole in the market where Regin AB could place their new product, good and bad features of the competitor products and also demands on the valve actuators that are not yet successfully fulfilled with the valve actuators of today.

The market analysis resulted in a product board (see appendix B – Product board) that showed many of the existing valve actuators on today's market. These actuators have many similarities when it comes to shape and over all function, but also differences. The actuators were divided into different categories with a repertory grid chart (see appendix C – Repertory grid chart). The repertory grid chart show that the existing competitor products can be divided into five categories due to their expression – Technical, Round, Discrete, Playful and Rectangular. The chart also helped with stating which expression the new valve actuator should have to be able to bring something new to the valve actuator product area. The products in the technical category in the repertory grid are seen as role models by Regin AB as they are popular among the valve-actuator costumers. The expressions missing in the valve actuator product category are modern and user friendly, which are values that should be implemented in the new valve actuator.

The two Regin valve actuator series together with the four competitor products that Regin AB saw as their biggest competition (see appendix D – Evaluated products) were further analyzed. Each valve actuator were divided into seven partial solutions - Overall design, Machine body, Inside components, Lid design, Manual adjustment tool, Spider locking principle and Actuator-valve locking principle. The partial solutions of the four competitor products and the two Regin products are presented in appendix E – Competitor analysis.

To determine the pros and cons with the different actuators, information about the products were gathered and interviews were held with members of the Reference group. The top three valve actuators, based on the research and interview result, are the Belimo valve actuator *NVY24-MFT-R*, the Schneider valve actuator *Forta* and the Sauter valve actuator *AVX*.

3.2.3 THE REGIN VALVE ACTUATORS

Regin AB has two valve actuators in their product range; the RVA series and the HM1150X series.

The valve actuator of the HM1150X series

The valve actuator of the HM1150X series is a Regin product that was part of the acquisition of the German company RICCIUS + SOHN in 2008 and is sold mainly on the German market. The valve actuator is a large product with a lot of visible functional details. The product leaves more to wish for when it comes to usability and assembly/disassembly aspects. It is also harder to manufacture as it consist of many different components. The large number of components also makes the valve actuator harder to serve since loose part can be lost when the product is opened and it also became harder to locate the actual problem inside the product with a lot of inside details to choose from. When it comes to the force of the valve actuator, the engine together with the gear box generates a force of 1500N.

By consulting Mark Riccius, associate of Regin AB responsible for the German market, the pros and cons with the valve actuator of the HM1150X series could be stated.

Pros:

- The same chaise is used for all applications and manages to fit all sizes of engine and other inside components
- The actuator is strong and can be used for many applications
- The actuator feels robust
- The actuator comes with a slender spider-locking principle (but the solution demands a strong material)
- The product design use colour coding

Cons:

- The actuator feels too big and clumsy
- The actuator has a boxy and prototype-like design
- The actuator includes a lot of different components that makes it hard to manufacture, assembly and disassembly
- The hand manoeuvre wheel is hard to reach and have low usability
- The screws holding the adaptor solution used for Regin valves are hard to reach when mounting it
- The large machinery in the product occupy much space
- The holes leading the cables into the lid are hard to remain impermeable after once pointed a hole in them
- The rubber frame in the lid sealing is loose and hard to keep on the proper position in the mounting face and when the actuator is served

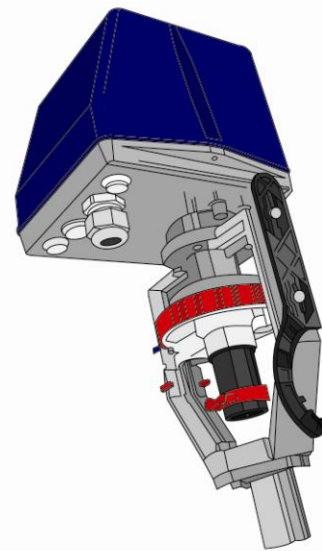

Figure 3 *The valve actuator of the HM1150X series*

The valve actuators of the RVA series

The valve actuators of the RVA series were developed via a joint venture with a company in Taiwan in 2008, and have since then been sold successfully in most of the active Regin markets. The valve actuators of the RVA series have a slender expression and fulfil the functional requirements of a valve actuator successfully. When it comes to the design the product gives a feeling of a prototype rather than a finished product. The RVA valve actuators come in difference size depending on the use situation. All sizes have automatic self stroke adjustment, they can be operated manually and they have protection class IP54¹ and a position indication. The main difference between the actuators in the RVA series is the size, the control signal and the motor force. The smallest actuators in the series are 85x150x250 mm, are used for 3-point control signals and generates a force of 500 N. The large actuators are 135x200x310 mm, are used for a 0(2)...10 V control signals and generates a force of 2500 N. The stroke length also varies between the different sizes of RVA valve actuators. The small RVA valve actuators have a stroke length between 10 and 30 mm (20 mm fixed stroke) and the large RVA valve actuators have a stroke length between 10 and 52 mm (40 mm fixed stroke).

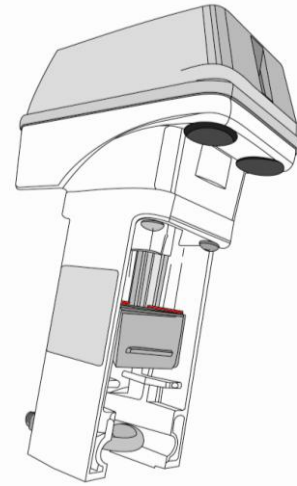

Figure 4 *The Regin valve actuator RVA5-24*

Pros:

- The actuator has a functional spider locking solution
- The spider head adaptor makes the actuator functional on many different spiders/valves
- The manual adjustment tool on the top of the product raise the usability level and also make the actuator easier to sell
- The automatic shut down before manual mode is good from a safety point of view
- The actuator come with a compact machinery solution

Cons:

- The plate in the spider locking can break by a force of 3400 Newton
- The engine in the small RVA actuator is too weak for some applications
- The actuator uses coloured aluminium
- The actuator uses little colour coding

¹ IP54 is a classification of the product sealing, i.e. how well it withstands touch, dust and water. The classification consist of the letters IP followed by two numbers, in this case 54. The first number describes the accessibility of live parts and the other the water protection. The values of the number goes from 0 – No protection to 6 - Full protection and by looking in a chart you can determine that a product with an IP54 classification is protected from dust and manage pouring water from all directions.

3.2.4 THE COMPETITOR VALVE ACTUATORS

Below the pros and cons of the different competitor valve actuators, based on the interviews, are presented.

Forta, Schneider:

Pros:

- The actuator feel functional and thrust worthy
- The actuator has a compact design
- The actuator has a small number of components
- The parts that should be interacted with are clearly shown
- The manual adjustment tool are discrete but noticeable
- The colour coding in the actuator are used successfully

Cons:

- The actuator can be hard to detect in the use environment

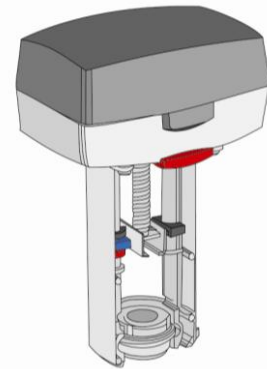

Figure 5 The Schneider valve actuator Forta

Sauter electric stroke actuator, AVX series:

Pros:

- The actuator has an automatic fetching of spider where different “fingers” go down and enclose the spider head
- The actuator feels strong and trustworthy
- The actuator has a simple and modular design
- The manual adjustment tool is easy to detect and simple to use
- The actuator is easy to locate in the use environment

Cons:

- The actuator is very large (the largest of the analysed products)
- The spider has to be adapted to be able to use with this locking mechanics in the product
- It is complicated to unlock the spider fastening

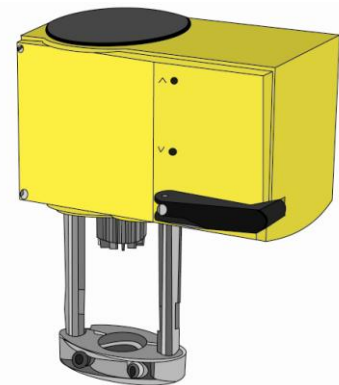

Figure 6 One Sauter electric stroke actuator of the AVX series

Belimo, NVY24-MFT-R:

Pros:

- The actuator has an automatic fetching of spider
- The actuator has a technical and strong appearance
- The actuator is considered functional and robust by its users
- The actuator has a compact machinery similar to the one of the RVA valve actuators
- The actuator is easy to locate in the use environment

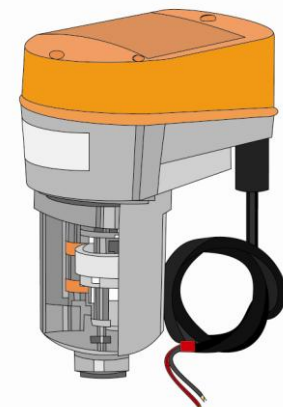

Figure 7 The Belimo valve actuator NVY24-MFT-R

Cons:

- The actuator has no hand manoeuvre tool

Siemens, SQX-serie:

Pros:

- The actuator feels trust worthy

Cons:

- The actuator can be hard to detect in the use environment
- The actuator has a simple design that do not make it stand out from its competitors
- The actuator uses no colour

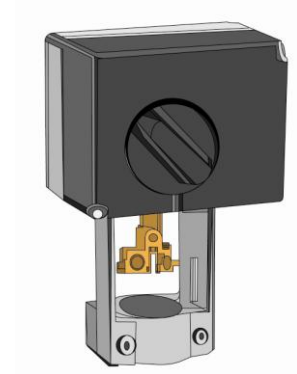

Figure 8 *The Siemens valve actuator of the SQX-series*

3.3 BRANDING

During the branding phase interviews with Regin AB representatives both from construction, marketing, sales and product development were held to determine the branding idea and what the different departments wanted the new valve actuator to express. These opinions were then combined into overall brand/design values of Regin AB. Mark Riccius from the German company RICCIUS + SOHN were also interviewed at this stage, an interview that resulted in a description of the German design values.

The interviews held were based on the following questions:

- Why does the valve actuator need to have a certain character?
- What does a Regin-product look like?
- Which values do you wish to express to your customers?
- Do you think you succeed in expressing these today?
- Which design features in the existing Regin valve actuators should be kept/eliminated?

The results of the interviews were the establishment of overall design values that should be included in the new valve actuator. In the branding part the Regin brand and design values were also determined by evaluating the existing Regin products and finding similar features like shapes, lines expression etc. In this face a Regin brand chart was made showing the colours, materials and signature lines and expressions that are typical for a Regin product and that should be used in the new product suggestion as well (more of this in part 3.3.2 The Regin values and brand).

3.3.1 WHY A CERTAIN CHARACTER?

A valve actuator needs to have a noticeable design and character as it is sold online on the Regin homepage, in a product catalogue or person to person at an office table or at fairs. At all these situations the costumer should be appealed by the product design, feel that the product is functional and trustworthy and in that way be convinced in buying the product. The valve actuators are sold as a complete solution together with valves or by themselves, why they should be able to fit the rest of the Regin products and also be able to stand out by themselves. The valves of different companies are very similar as valves are more about function than

design and expression. Because of this the valve actuator is the product, in the valve-actuator context, that can help the company stand out among their competitors.

Another reason for having a clear design character is to make the product easier to sell to the clients. The features that the product includes, such as buttons, wheels, logos, symbols and clever solutions are things that the sales men can talk about at fairs and at the office table. The potential buyer could then try the different features and in this way gain a liking for the product. This thing is called the VÄNS-effect among sales persons, where VÄNS stands for Vidrörd Är Nästan Såld (Touched Is Almost Sold). This effect is something that Lasse Bornö and his fellow sales men at Regin AB uses at fairs and in any other sales moment and that is a feature that they want to implement in the new valve actuator. The VÄNS-effect can be explained as when the costumers starts using the product and test its different functions (s)he will soon get a liking of it (given that the product works as it should) and (s)he is then much more easily convinced in buying the same product.

Baxter 1995 discusses how we look at product and which features that lies behind the liking of a certain product. According to Baxter our analysis of visual information takes place in two discrete ways. First (the preattentive global processing) the overall product is scanned to look for patterns and shapes. Secondly (the attentive processing) we deliberately focus on details of the product to examine its component parts. This statement help in forming an aim for the design of the new valve actuator, where the user first should gain a liking of the whole product, after which her/his eyes should be drawn to the different parts that the (s)he should interact with.

Baxter also mentions that much of our judgment of style is determined by preattentive global processing and that we when we talk about the overall form or image of a product, we are actually referring to our global perception of it. *“When we design an object to be beautiful, we must design it to correspond with the perceptual properties of human vision. Understanding vision, therefore, becomes the key to creating beauty and the rules of pre-attentive visual perception should translate into principles of product styling.”* (Baxter 1995, pp. 36)

“When we first see an image our brain is ‘programmed’ to extract certain types of visual patterns which are then constructed into a meaningful image. This programme develops according to the visual stimuli we are exposed to during development.” (Baxter 1995, pp. 37). The gestalt rules of visual perception (suggesting that human vision is somehow predisposed to see certain types of pattern) are the operational rules for this programme in our brain. (Baxter 1995)

The most important gestalt factors are

- 1) Proximity: the closer, the clearer
- 2) Similarity: figures with the same properties form gestalts
- 3) Area: the smaller the area, the clearer the gestalt
- 4) Symmetry: symmetry creates a gestalt
- 5) Enclosedness: lines that enclose a surface create a gestalt
- 6) The good curve: the arrangement that causes the minimum change or break in straight or uniformly curved lines creates a gestalt

(Monö 1997)

Some of these factors should be used in the design of the new valve actuator to make it more adapted to our pre-attentive visual perception and to hopefully make the product seem more beautiful.

3.3.2 THE REGIN VALUES AND BRAND

One demand from Regin AB was that the design of the new valve actuator should fit the Regin brand. It should be clear that the new valve actuator is a Regin product and the design of the product should match the Regin design language. To determine which features that are equal for the Regin products an evaluation of the Regin brand was made. Regin AB has many different products in their product range that are more or less true to the Regin brand. The stating of the Regin brand was based on the three products that Regin AB felt was most true to their values - Corrigo/Optigo, RU and Pulser. The evaluation were made by studying the shapes and signature lines from the angle that the user meet the products (the interaction angle), see figure 9 *Shape and signature lines of the Regin products Corrigo/Optigo, RU and Pulser*.

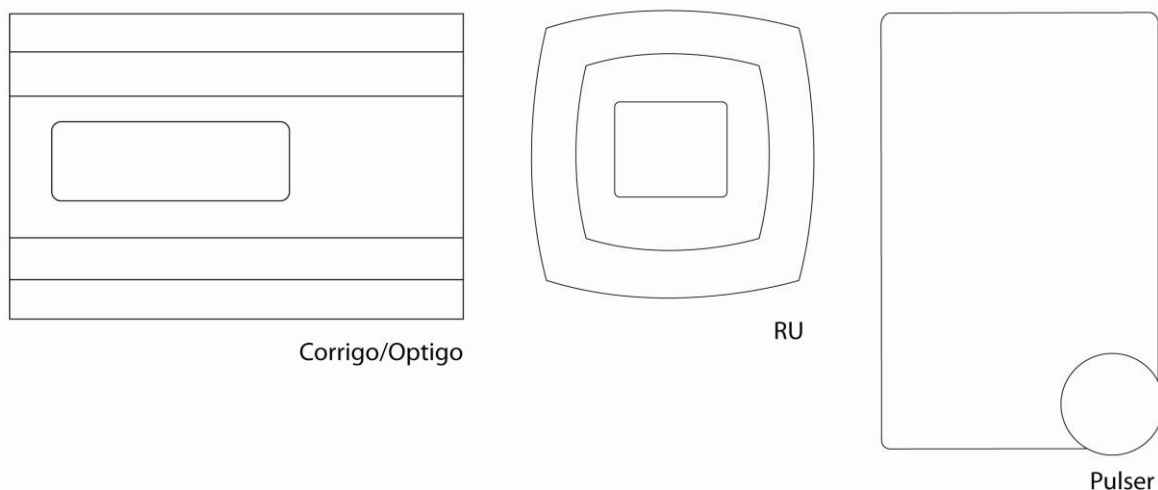

Figure 9 *Shape and signature lines of the Regin products Corrigo/Optigo, RU and Pulser*

The colours used in the products, the expression of the different products and the materials used in the existing valve actuators in the RVA series formed a Regin brand chart (see Appendix F – Regin brand chart). These features were then used as a guide when developing the new valve actuator.

- The colours used in the Regin products are mostly white and light grey combined with smaller elements of green and black/dark grey. The exception of this is the Regin valves which come totally in green.
- When you look at the shape and signature lines Regin AB uses the basic shapes of circles and rectangles that are combined in different ways to get a final product shape. The shape uses many of the Gestalt factors from part 3.3.1 “Why a certain character?”, and is constructed after how the product should be used. The regulators and buttons often come in another shape than the overall one (from square to circular etc) which increases the usability in the product since the parts that the user should interact with are

emphasized and therefore more easily found. The signature lines in the products are kept simple and are added to accentuate the shape of the products.

- The values that the Regin products express are clean, functional and user-friendly.
- The materials used in the RVA valve actuator series are Aluminium, Stainless steel, Iron, Copper, Zinc, Tin (Lead-Free), Magnesium, Silicon, Polyoxymethylene, Fibre glass, Epoxy, Nylon66 and Nitrile Nutatiene Rubber.

3.3.3 *THE GERMAN VALUES AND DEMANDS*

The following information has been gathered from interviews with Mark Riccius, Lennart Spiik, Per Sandström and Jimmy Hallberg at Regin AB.

As was stated in part 1.2 “Task”, the only country that has not yet fully accepted the RVA valve actuator series is Germany. To be able to attract the German industry the function and the expressions they want to see in a valve actuator needs to be stated.

The design values that is appealing to the German industry is

- Robust
- Technical
- Genuine
- Strong

The reason to why the RVA valve actuators are not successful on the German market is that the German costumers feel that these actuators are less wearable and trustworthy than the valve actuator of the HM1150X series and other German valve actuators. The German industry wants a product that is quick, strong and watertight, that manage the demands of an IP54 classification, that has a minimum amount of loose components, that is easy to manufacture, assemble, mount and disassemble/recycle, that has screws and other mounting details that are easy to reach and handle as well as is functional and wearable.

One big difference between the valve actuators of the RVA series and the valve actuator of the HM1150X series is the generated motor force, which is stronger in the valve actuator of the HM1150X series. As was mentioned in part 3.2.3 “The Regin valve actuators”, the valve actuator of the HM1150X series generates a total force of 1500N, a force that the new valve actuator of Regin also should be able to generate. The new valve actuator should also be able to fit the German valves either with the product design/shape or with an adaptor.

According to Riccius there are no parts of the valve actuator of the HM1150X series that the German representatives are eager to keep and he encourages an innovative and usability thinking. There is no problem to stick to the Regin colour chart and when it comes to the esthetical aspect the new actuator should feel modern and different and come with functions and interaction parts that are clearly shown by shape and colouring. The materials used in the product should feel genuine and contribute to an overall robust expression.

An assumption made in the early stages of the thesis work was that the German industry disliked slender and small solution. This was disproved by Riccius who claimed that the

German industry has started to accept slender solutions much more as long as they still bring the expressions valuable to them as well as function in satisfying way.

3.3.4 ECONOMIC JUSTIFICATION

Regarding the economical aspects the new valve actuator should not cost more than the existing Regin valve actuator RVA 5-24, which is 600 SEK. This is a small amount of money and leads to the fact that the new valve actuator should have a design that is easy to manufacture, that has a minimum amount of parts, that uses the good features of the original Regin valve actuators (so that a minimum amount of new templates needs to be developed), that demands non or a small amount of finishing work (such as processing, grinding and polishing) and that uses coatings and colouring only where it is necessary for the function, design expression or usability. Standardized part should also be used in a large extent as possible.

Since the cost in most cases is larger in the beginning of the production of a new product it is expected that the cost will be more than 600 SEK in the early stages of the new valve actuator life, but that this cost will be lowered in time. The reason why the cost is higher when a new product is developed is that new templates, new machines and working methods and new packaging, marketing aids etc needs to be developed, which automatically raises the total cost. A fact that helps lowering the total cost for Regin, when introducing the new valve actuator on the market, is that this new product is meant to replace two other products with two manufacturing processes, two assembling processes etc, which in total is an economic gain for the company.

4. CONCEPT DEVELOPMENT

“A concept is a description of the form, function, and features of a product and is usually accompanied by a set of specifications, an analysis of competitive products and an economic justification of the project.” (Ulrich & Eppinger 2008, pp. 15)

The concept development of this Master’s Thesis consisted of two different parts – overall design expression and functional solutions. It should also be determined which features in the existing Regin valve actuators that should be used also in the new valve actuator and which should be redesigned/excluded.

4.1 REQUIREMENTS ON THE NEW VALVE ACTUATOR

The result from the interviews, together with knowledge from visits and theoretical studies were summarized in a KJ-analysis, which helped structure the different criteria into requirement categories. The requirements were then turned into a requirement list that in its first version was built up by 60 demands. These demands were then narrowed down to 33 demands which were of most value to Regin AB. The demands were then weighted against each other according to importance in a weigh matrix. The result was a list showing the hierarchy of the demands from the most important to the least important (see appendix G – Weighted demands).

4.2 OVERALL DESIGN

The overall design of the product was based on the Regin brand chart and the German design values - robust, technical, genuine and strong, stated in part 3.3.2 “The Regin values and brand”. The process began with several brainstorming sessions that resulted in a large amount of sketches that were more or less realizable. Some of them are presented in appendix H – Early sketches. The next step was to concretize the ideas by dividing the valve actuator into different areas – Inside components, Product shape and Functional solutions. These areas were then worked with one by one.

4.2.1 INSIDE COMPONENTS

An important part of the concept development process was to determine which inside items that should be included in the product and to manage to fit all the components inside the product. The inside components that needs to be included in the product are 1 motor, 1 circuit board, 2 sprockets and a machine body keeping all the components in the correct location. It was discovered that the placement of the two sprockets set the demands for the total design since they could only be placed in a certain way to get a good location of the manual adjustment tool and to have the spider beam centred in the product.

Manufacturing and assembling aspects were also considered in this stage to be able to further optimize the accessibility in the product. The result of this work was a framework for how the inside of the new valve actuator should look and how all components should be arranged inside the product (see appendix I - Inside components). A minimum size of the actuator, to enable for it to store all the necessary components, was also stated. As can be seen in appendix J – Shape analysis, the optimal shape of the product is rectangular since this shape manages to fit all the inside details such as motor, circuit board, sprockets etc. and still give a slender but

robust expression. The rectangular shape could also be found in other Regin products and therefore help expressing Regin design values.

4.2.2 PRODUCT SHAPE

Another aspect considered when determining the overall shape of the product was the fact that the valve actuator is seen sidelong from above/underneath when it has been mounted and it is therefore important to determine how the product looks and what it expresses from this direction. As was mentioned in part 1.2 “Task”, the design of the valve actuator should exclude it from the rest of the products on the market, which is done by adding design features that do not exist in the valve actuators on the market today and that is true to the Regin brand, feels modern and functional and expresses the values important for the buyers/users. The new valve actuator should have a clean design and clearly visible colour and the colour green that is typical for the Regin brand needs to be shown in a clear way.

4.3 FUNCTIONAL SOLUTIONS

The functional solutions are divided into five parts – Lid opening, Manual adjustment tool, Spider locking principle, Actuator-valve locking principle and Location scale.

4.3.1 LID OPENING

The first thought with the lid opening was that it should be easy to open and give clues to the user of how it should be used. The first idea was to use a button on each side of the product that was pushed down in order to open the lid. This solution showed to be contra reductive since the lid should be easy to open by a person that have the right tool (for example a screwdriver) but unavailable for the random person. By security aspects you do not want someone unauthorized go and open the lid and get into the motor and the sensitive devices inside the lid and the lid should therefore be designed so that these parts are available only for the persons authorized to use them. This is easiest and cheapest done with screws securing the lid to the machine body which is also a solution that feels technical, functional and genuine.

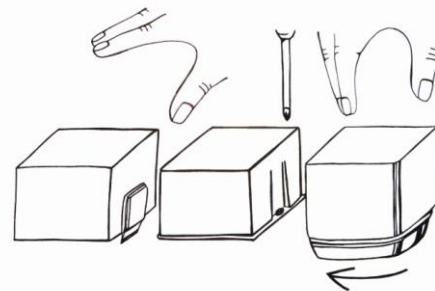

Figure 10 *Conceptual solutions to the lid opening*

4.3.2 MANUAL ADJUSTMENT TOOL

Since the manual adjustment tool that Regin AB uses in the RVA valve actuator is much liked by their users and by Regin AB themselves the choice was made to keep the function of this tool but change the location of it and by adding some colour coding. Another pro with the RVA manual adjustment tool is that it has a manual clutch which engages the manual adjustment tool and disengages the motor which is good from a safety point of view since there is no chance that you can manually adjust the machine at the same time as the motor is running.

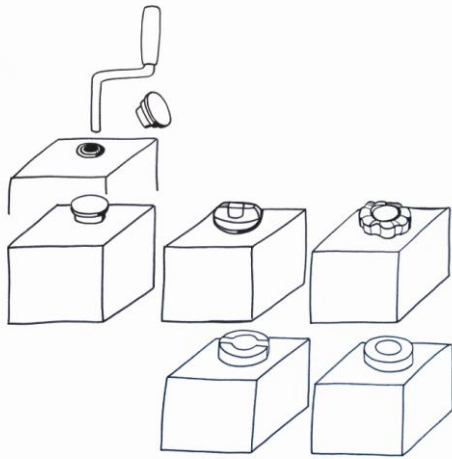

Figure 11 *Conceptual solutions of the manual adjustment tool*

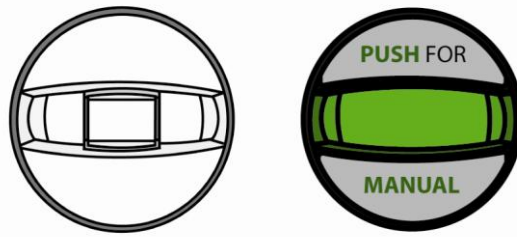

Figure 12 *Idea of how to implement colour coding in the manual adjustment tool*

One question to solve when designing the manual adjustment tool was whether it should be visible or hidden under the lid. After consulting the members of the reference group a visible manual adjustment tool was shown to be preferable both because of the VÄNS-effect (explained in chapter 3.3.1 “Why a certain character?”) and that the visible manual adjustment tool is really popular among the Regin costumers. The next question was where on the product the manual adjustment tool should be placed to be easily reached from where it is located. Since the valve actuator usually is mounted in a tilted location a manual adjustment tool on the top of the valve actuator is preferable.

4.3.3 THE SPIDER LOCKING PRINCIPLE

The locking of the actuator onto the valve with the spider have been analyzed and several ideas came up from which two solutions where chosen to develop further. The first solution, solution a in figure 14 *Illustrations of the conceptual solutions of the spider locking principle*, is a concept that is more linear than the solution used in the RVA valve actuators today and that using different geared components to get a full spider locking solution. The colour red is used on the final component that locks the whole assembly. The screwing/locking of this final devise makes the whole locking process intuitive for the user as (s)he feels the spider lock as he screw the item. The con is that the locking solution is not visible from a top-side view - the interaction angle (see appendix K – New spider locking principle).

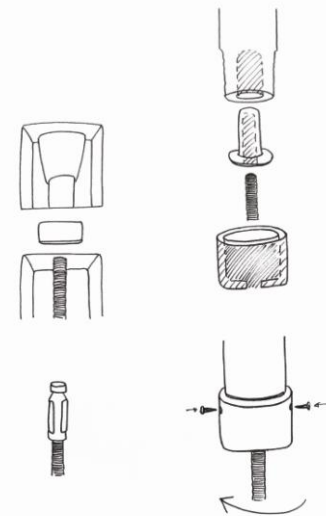

Figure 13 *Conceptual solutions to the spider locking principle*

The second solution, solution b in figure 14, is further developed from the spider locking principle used on the actuators in the RVA series today. The new solution has a red coloured button and a more solid body that fit with the machine body of the actuator more. The large red button also gives the locking solution higher usability and a more genuine look.

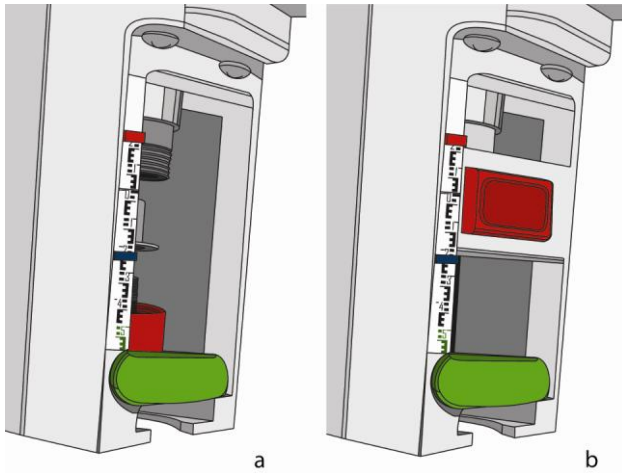

Figure 14 *Illustrations of the conceptual solutions to the spider locking principle*

4.3.4 ACTUATOR-VALVE LOCKING PRINCIPLE

“The actuator must be attached securely and rigid to the valve body. A compact assembly is preferable, to reduce space requirements, the chances of accidental damage and the likelihood of structural vibration problems”. (Nesbitt 2007, pp. 280). The actuator-valve locking principle used in the valve actuators of the RVA series can be found in most of the competitor product as well (see appendix F – Competitor analysis). This actuator-valve locking solution is also simple, cheap and functional why the decision was made to use it in the new product as well.

4.3.5 LOCATION SCALE

As could be read in part 3.1.5 “Handling”, the valve actuator is the product that the user interacts with in the control room, which is the reason why it needs to stand out and be seen in the use environment. The costumers want a valve actuator that is easy to understand and handle when they have to handle it. This happens when there is a problem in the building for example if the building is to hot or too cold. The caretaker observes the valve actuator to see how it is located and if the location has changed since last time. If a problem occurs the caretaker adjusts the valve actuator manually until the problem is remedied. Because of this use the valve actuator needs to have distinct symbols and scales that help the caretaker to determine what is wrong and which current location the valve actuator has (if it is open or closed/on or off). In part 3.1.5 “Handling” it is also mentioned that there is a problem for the user to in an easy way determine the current location of the valve actuator. By some users this problem have been solved by painting a handmade scale onto the product (see figure 15 *Hand painted scale*).

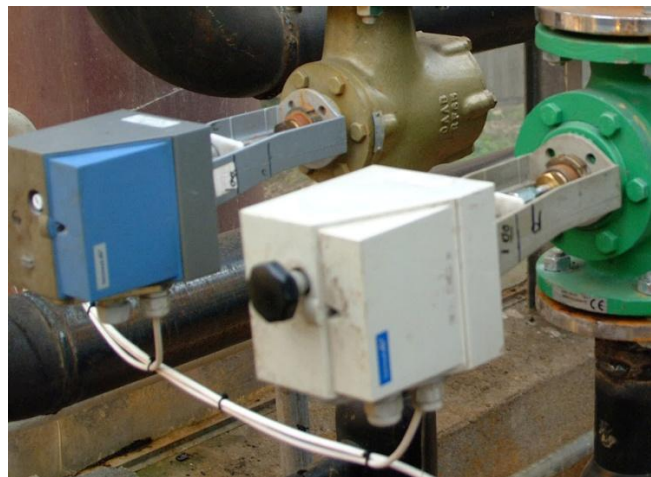

Figure 15 *Hand painted scale*

The demands put on this kind of scale are that it should give the necessary outputs to enable for the users to check the valve actuator parameter to do an accurate trouble shoot of the

building when a problem occurs. The scale should also be clearly visible from different locations; near and more far away. The scale also needs to be adjustable in height when the valve actuator is installed so that the zero point land up in the correct location. This adjustment is usually done only once. The user does not need an exact output in millimetre since the length of stroke is only between 0 and 40 mm (Spiik, 2010). The scale should instead in a distinct way show whether the actuator is on or off; have a clear difference between these two locations that could be determined even from a longer distance. Another demand, stated by Regin AB, is that the shape of the scale should not affect the shape of the machine body so that holes need to be done in it.

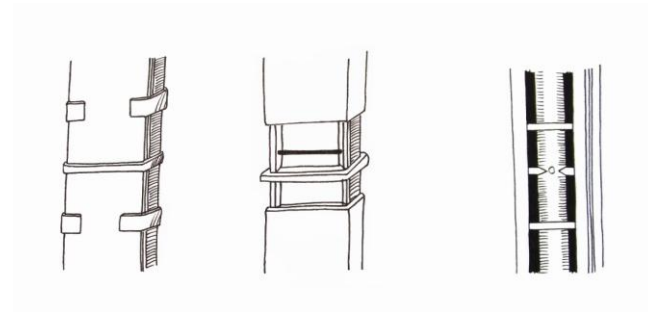

Figure 16 *Illustrations of the conceptual solutions to the location scale*

4.4 THE CONCEPTS

By discussions with the Reference group the ideas were narrowed down to three different concepts with different partial solutions called 1a, 1b, 2, 3a, 3b, 3c.

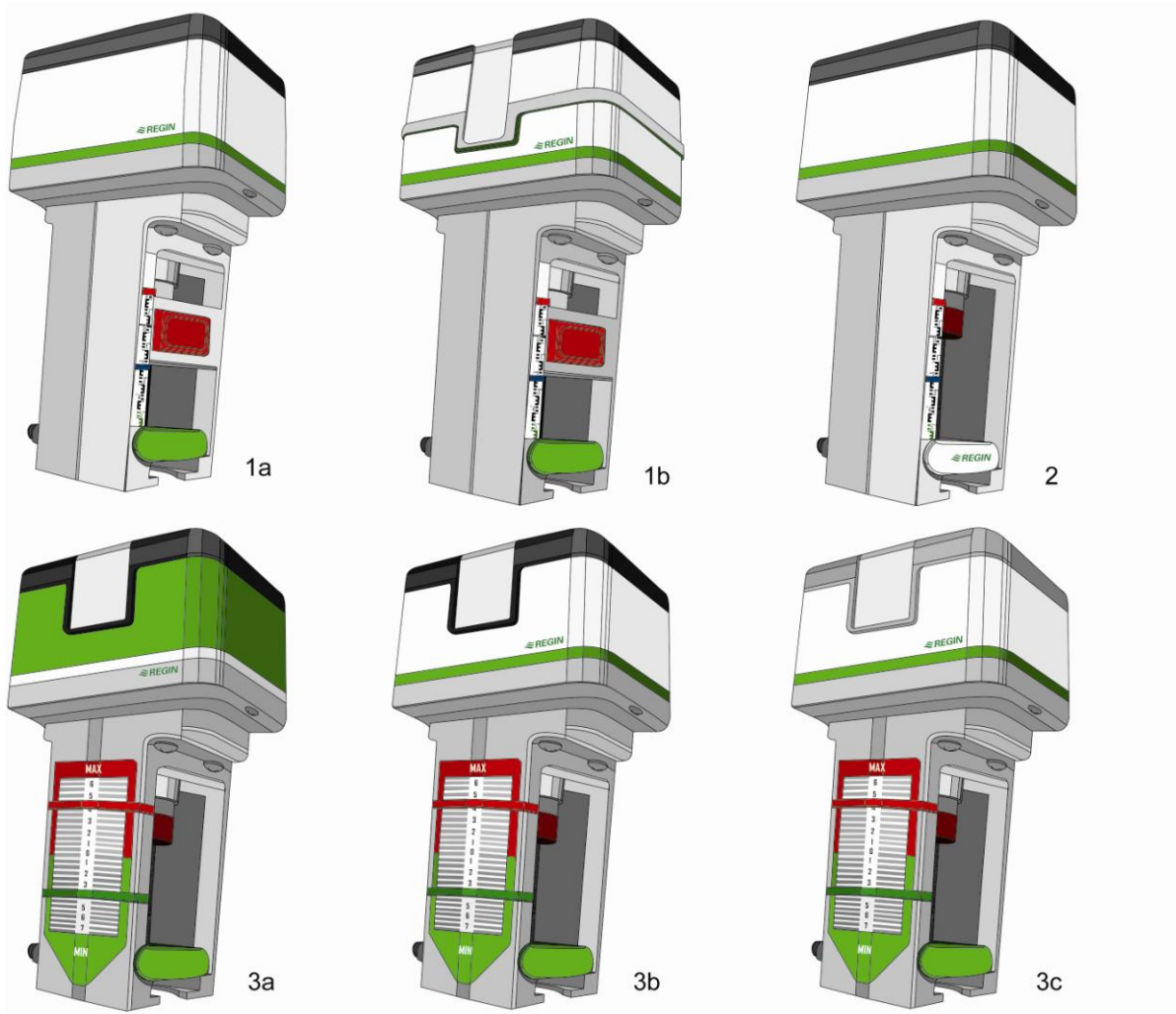

Figure 17 *The concepts*

In all the concepts the motor used is the larger one today used in the HM1150X valve actuator but mounted in a similar way to that in the RVA valve actuators. The valve locking is similar to that of the valve actuators in the RVA series but has a more thick front that minimizes losses between the actuator and the valve.

The rectangular shape of the motor house is the same in all the concepts and manages to fit all the inside details such as motor, circuit board, sprockets etc. On the side there is a green line that is actually an inner lid that makes the product seems more genuine and makes the mounting and handling easier. The inner lid makes the actuator feel more solid as all components lies in an ordered way inside the product. The green line caused by the inner lid also show the Regin colour in a clear but yet discrete way.

The machine body is kept simple in this stage but should be evaluated more before the final concept is determined.

The scale is a sticker that is fasten on the machine in the mounting face and then stuck there for the rest of the using time (approximately 10 years). The sticker comes in two variants depending on if it is a heating or cooling device that the actuator in attached to.

The top lid has a rubber frame that makes it easier to hold and use the product.

4.4.1 CONCEPT 1A

This concept could be seen as a further development of the principles of the RVA valve actuators combined with usability and handling aspects together with Regin design values. The spider locking is a further development of the old RVA principle. The signature lines of the product are clean and kept simple, the scale is small but yet visible and the overall design is formed so that it should be easy to manufacture.

The logotype is placed on the side of the actuator to make it visible from sidelong above which is the view that you usually see the actuator after it has been mounted. The parts that the user should interact with are coloured – the valve locking is green and the spider locking button is red to make the usage simple and more intuitive.

4.4.2 CONCEPT 1B

This concept is similar to concept 1a, but the lid is divided with lines to give the actuator another expression and to cut the large white side in smaller pieces. These lines could be used to give the actuator an own and distinct expression and is similar to the lines that Regin AB uses in some of their other products. The most important thing is that the lines should not just be a line but have a purpose. The shape of the middle line gives clues of that these two pieces should be mounted together.

4.4.3 CONCEPT 2

This concept uses another spider locking solution that consist of different threaded pieces mounted together to get a small and straight locking that interpret how the spider moves. This locking is not visible sidelong from above which can be both good and bad. You get a smaller solution but loose the VÄNS-effect of a button. The scale of this concept is the same as in 1a and 1b but the logotype is moved to the valve actuator locking device. This creates a nice transit between the green Regin valves and the actuator but is not that visible when the actuator is mounted.

4.4.4 CONCEPT 3A

In this concept the scale is larger than in the former concepts to make it more visible from a longer distance. The side shape of concept 1b is further developed. The lop lid is green while the inner lid is white. This was mostly done to play with the Regin colour green to determine how much this colour could be used and still have a technical and genuine expression instead of a toy like one. The logotype is moved down onto the aluminium frame.

4.4.5 CONCEPT 3B

In this variant the colours from concept 1 and 2 are implemented once again in this concept. The logotype is again put on the top lid. The spider locking device used is the one from concept 2, but could also be the first variant. The scale is the same larger one as in concept 3a.

4.4.6 CONCEPT 3C

This concept is similar to 3b but instead of a top frame in black rubber there is a grey one that gives a softer expression more similar to the expression of the other Regin products.

5. FURTHER DEVELOPMENT OF CONCEPT

The further development of concepts was based on the faces System-Level Design and Detailed Design stated by Ulrich & Eppinger (2008). In this case these two are combined to fit the wanted outcome of this Master's Thesis – a product suggestion of a new valve actuator.

The product development of this Master's Thesis includes a definition of the product architecture and the decomposition of the product into subsystems and components, the definition of a final assembly scheme for the production system (part of the system level design face of Ulrich & Eppinger) and the complete specification of the geometry and materials of all the unique parts in the product (part of the detailed design face of Ulrich & Eppinger). The outputs of these are a geometric layout of the product, a functional specification of product's subsystems and description of the product assembly.

5.1 CONCEPT EVALUATION

The further development process started with a concept evaluation where the concepts with partial solution variants was presented to two of the members of the reference group (Lennart Spiik and Lars Bromö) at a mid time presentation. The discussion was built up by the following questions: What do you think if the overall design, which solutions are of most interests in your opinion and should be refined/ used in the final concept? The task of the reference group was to discuss the different concept and to choose which solutions that should be eliminated and which that was interesting to further develop. The rest of the members of the Reference group were contacted via email in which the concepts were presented in figure and text. The purpose with this was that all members of the reference group should have the chance to say their opinion of the different concepts before the further development process started.

After the mid time evaluation the partial solutions of most value to Regin where further developed and combined into a final concept. This process helped form a more clear rote and goal for the work to come and also helped with concretize what the final concept should look like and which parts it should include.

During the concept evaluation it was stated that

- The overall design of the concepts succeeds in having a good compromise between a modern and robust expression and that the design also succeeds in matching the Regin design language with shape and colour.
- It is important that there is an idea/a reason behind every shape/line/design element.
- All representatives like the fact that the new actuator is smaller than the valve actuator of the HM1150X series but a bit bigger than the RVA valve actuator 5-24.
- Concept 1b and 1a is the most popular concepts. The solution is to find a combination between concept 1b and 1a with a line in the middle showing where the lid comes of (gives a clue of the function) and with a sleek design expression in mind so no unnecessary lines are used.
- The scale should be a symbolic scale showing whether the valve actuator is open or closed instead of showing the exact location of the spider. This is because the stroke lengths of the actuator not vary that much and it therefore is of small interest to get an exact value. When there is a problem in the building the care taker trouble shoots the

system. (S)He then want to clearly see how the different actuators are located (if they are opened or closed) to be able to adjust them manually if something is wrong.

- There are different opinions in the representative group regarding the size of the scale were some like large scales and some wants them more discrete. Large clearly visible scales are good since they are easily seen and easy to read. Some of the representatives also have had costumers expressing their want for large and visible partial devises. Another opinion was that the large scale could feel a bit too large and toy like. The solution then is to design a scale that is large enough to be easily seen from different angles without feeling too big.
- All the approached also liked the stick solution of the scale.
- The spider locking solution with the button and the same principle as the RVA valve actuators was most liked both because of its functionality and because of the VÄNS effect (explained in chapter 3.3.1 – “Why a certain character”) where the sales persons can talk about and show the feature to the customer, tell him/her to test them and then built up a liking and an eager to own the product.
- The sides of the actuator are something to work more with to get a nice shape and not a clumsy expression (there are a narrow line between robust and clumsy).
- They do not want the manual adjustment tool hidden as it is very good when they sell the product
- All of the representatives liked the logotype placed on the lid.
- The rubber frame of the top lid was seen unnecessary as well as a source of collecting dirt and dust and is not used in the final solution.

5.2 FINAL SOLUTION

The final solution should, as was stated in the objectives, be a product suggestion with ergonomic and design solutions, fundamental mechanical solutions and suitable material and manufacturing suggestions. The solution is presented as a Catia V5 model showing the outer as well as the inner designs of the product. The description of the final solution follows the same frame as earlier product/concept descriptions. The parts that are considered are overall design, machine body, inside components, lid design, manual adjustment tool, spider locking principle, actuator-valve locking principle and scale. Other aspects discussed are manufacturing, assembling, disassembling/recycling and material selection.

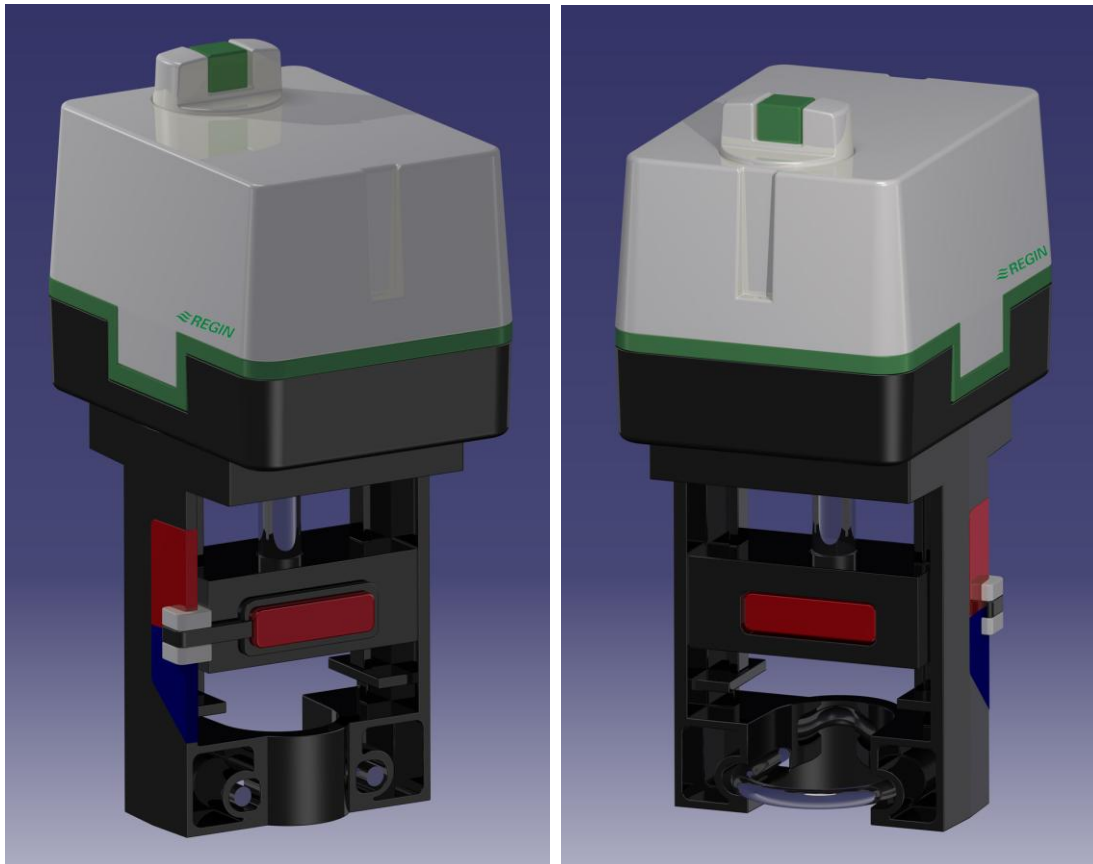

Figure 18 *Front and back view of the final concept*

5.2.1 PRODUCT ARCHITECTURE

As was stated in part 3.3 “Branding”, a valve actuator needs to have a noticeable design and character. The customer should be appealed by the design, feel that the product is functional and trustworthy and in that way be convinced in buying the product. In part 3.3 “Branding” it was also stated that the valve actuator should be able to fit the rest of the Regin products and be able to stand out by itself. In the same part it was also mentioned that the valve actuator is the product, in the valve-actuator context, that can help the company stand out among their competitors, an aspect that was considered in the development of the overall product design. It is also important that the design of the valve actuator fits the design of the Regin valve. The design of the Regin valve can be seen in figure 19 *The Regin valve NTVS for regulation of hot and cold water*. The green colour of it reappears in the valve actuator lid and the overall shape

of the valve actuator is designed to fit with the appearance of the valve to create a complete and robust locking valve-actuator solution.

As was stated in part 1.2 “Task” the design of the actuator should exclude it from the rest of the product on the market, which is done by adding design features that do not exist in the valve actuators on the market today, that is true to the Regin brand, that feels modern and functional and that expresses the values important for the buyers. The expressions missing in the valve actuator product category was in part 3.2.2 “The existing valve actuators” stated to be modern and user friendly, which are values that should be evaluated in the new valve actuator. One demand stated by Regin AB was that the design of the new valve actuator should fit the design values of the Regin and the German industry. These values were stated in part 3.3 “Branding” to Robust, Technical, Genuine, Strong, Clean, Functional and User-friendly have worked as a guide through the design process. Another demand stated in part 4.2.2 “Product shape” was that the new valve actuator should have a clean design and clearly visible colour. The colours typical for the Regin products – Green, white, black and light grey, should be shown in a clear way. The partial lines and details in the product should be a functional not only purely esthetical, which are things that have been considered in the development of the final concept.



Figure 19 *The Regin valve NTVS for regulation of hot and cold water*

In part 3.3.1 “Why a certain character?” it was stated that a reason of having a clear design and character in the new product is that this makes the product easier to sell to the clients. The features that the product includes, such as buttons, wheels, logos, symbols, clever solutions etc. are things that the sales men can talk about at fairs and at the office table. The potential buyer could then try the different features and in this way gain a liking for the product. This is called the VÄNS-effect, a sales term that was explained in part 3.3.1 “Why a certain character?”. VÄNS stands for Vidrörd Är Nästan Såld (Touched Is Almost Sold). This effect is something that Lasse Bornö and his fellow sales men uses in the sales moment and can be explained as when the costumers starts using the product and test its different functions (s)he will soon get a liking of it (given that the product works as it should) and (s)he is then much more easy to convince in buying the same product. Throughout the design process the VÄNS-effect has been considered and the aim was to develop more interactive elements in the valve actuator.

The overall design in the final solution is made based on a modular principle and the aim was to keep the valve actuator as compact as possible. The measurements, both outside and inside of the product and the connections between the components were determined with the RVA5-24 valve actuator and the earlier concepts as a reference. Product semiotic aspects and colour coding was used to create a product with high usability where the parts that the user should interact with are easy to find. In the demands it was stated that the valve actuator should only be coloured where it’s necessary for its function or its identity/expression. This demand resulted in a limited use of colour only on the parts that the user should interact with. This helped in distinguish these parts from the rest of the product components which increases the usability in the product.

In part 3.3.1 “Why a certain character?”, an aim was formed to develop a design where the user, according to the teaching of Baxter 1995, first should gain a liking for the whole product and her/his eyes should then be drawn to the different parts that the (s)he should interact with. As was mentioned in part 4.2.2 “Product shape”, the concept of the valve actuator is seen sidelong from above/underneath when it has been mounted and it is therefore important to determine how the products look and what it expresses from this direction. With this in mind the logotype of the product is placed on the low part of the side of the top lid. One aim with the overall design of the product also was that the bottom half of the valve actuator should make the top lid more prominent, an aim that was solved by colouring the machine body in black which also gave the product a more modern and high tech look. The prominent top lid also helps visualize the part of the product that the user should be able to navigate to when a problem occurs.

When it comes to shape and signature lines the shapes often used in the Regin products are basic shapes of circles, and rectangles that are combined in different ways to get a final product shape. The aim with the shape of the new valve actuator is that it should use this same basic shapes and also work with the Gestalt factors presented in part 3.3.1 “Why a certain character?”, to be able to develop a product that is considered beautiful by the buyers. In part 3.3.1 “Why a certain character?” the most important gestalt factors were also presented as a way of getting a design solution that corresponds to the perceptual properties of human vision, which can be done by using the gestalt rules.

One overall vision with the product design was that the product should be constructed after how the product should be used and the regulators and buttons often come in another shape than the overall one (from square to circular etc). This is done to help the user distinguish which parts that (s)he should interact with, which lead to a more user-friendly product in total. The signature lines in the product are kept simple and are added to accentuate the shape of the product.

The gestalt rules that were used in the development of the new valve actuator were:

- 1) Proximity: the closer, the clearer
Design solution: The buttons and manoeuvre tools controlling different mechanical functions should be placed as near the mechanical output as possible so it is easily determined which regulators controlling which metrics.
- 2) Similarity: figures with the same properties form gestalts
Design solution: All items that the user should interact with have a colour and the similar shape should be put together. This was also used in the spider locking solution where the shape of the black measurer have been adapted to create a gestalt together with the red button since these two parts work in unison. The similarity factor also helps determine how the top lid should be opened/closed, and how the whole motor house should be assembled, thanks to the bent shape that can be found both in the top lid, the green middle lid and the black chassis – the bottom part of the motor house.
- 3) Area: the smaller the area, the clearer the gestalt
Design solution: The area factor deals with the fact that the smaller area in a view we see the most easily. This fact was used for all devices that the user should be able to find easily and interact with. These are the manual adjustment tool that is placed on the top lid of the product where it stands out from the rest of the plain surface from this view,

the spider looking solution with its red button and prominent frame that stands out from the rest of the black machine body. The same goes for the scale, the measurers attached to the scale and the top lid that are able to stand out from the rest of the product thanks to the distinct shape and colouring.

The identity label that needs to be included in the product is placed on the back of the product at the black motor house chassis (see figure 20 *Placement of identity label*).

5.2.2 SUBSYSTEMS AND COMPONENTS

Machine body

The demands on the machine body were that it should be robust and strong and that it should help deflect heat from the sensitive parts in the top of the product and instead be absorbed by the machine body. There are two ways of getting more heat absorption, first you can design a large area in the bottom close to the valve and secondly you can enlarge the area of the machine body connecting the fastening device with the top parts. Both these aspects have been implemented in the new product design which will help deflecting the heat from the sensitive parts of the product and result in a more secure and wearable product.

The machine body is inspired by the machine body of the RVA but the proportions of it is changed to express robustness and strength and to fit the shape of the other product components. The machine body is build up by three pieces. One framework part, one middle part holding the spider locking solution and one upper part that is actually the chassis of the motor house. All these parts are made of aluminium and coloured in black to fulfil the goal stated in part 5.2.1 “Product architecture” - that the bottom half of the valve actuator should make the top lid more prominent. The black colour of the machine body also helps in making the other components that should be prominent – the red spider locking bottom, the scale and the measurer associated with the scale, more easily seen.



Figure 20 *Placement of identity label*

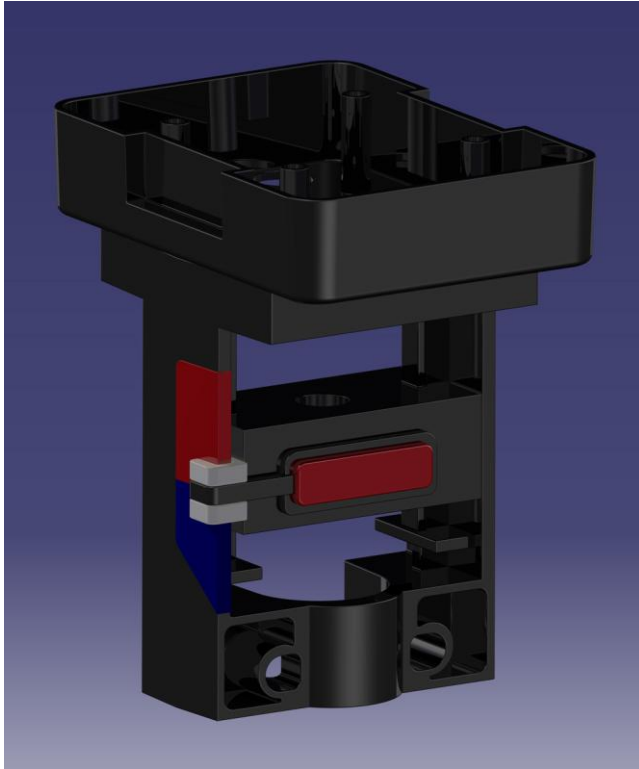

Figure 21 *The machine body and the under lid*

Inside components

As was stated in part 4.2.1 “Inside components” the inside components that needs to be included in the valve actuator are 1 motor, 1 circuit board, 2 sprockets and a machine body in the lid keeping all the components in the correct location.

- The motor in the HM1150X is powerful enough to fulfil the demands of the German market.
- The size of the circuit board is the same as the one used in the valve actuator RVA5-24, which have been proven to work for this kind of product.
- The sprockets are of the same size as the ones in the valve actuator RVA5-24 to enable to get the same torque when manual adjusting the machine. The placement of the sprockets was determined by the wanted location of the manual adjustment tool and the stroke beam, which should have a location on the centre back of the lid respectively in the middle of the product.
- The machine body in the motor house is the green inner lid that has been designed to hold the motor, circuit board and sprockets in a correct location. The green colour of the inner lid also helps with emphasize the different motor parts, which makes the serving of the valve actuator more simple as the different components are easier to find and distinguish from one another.

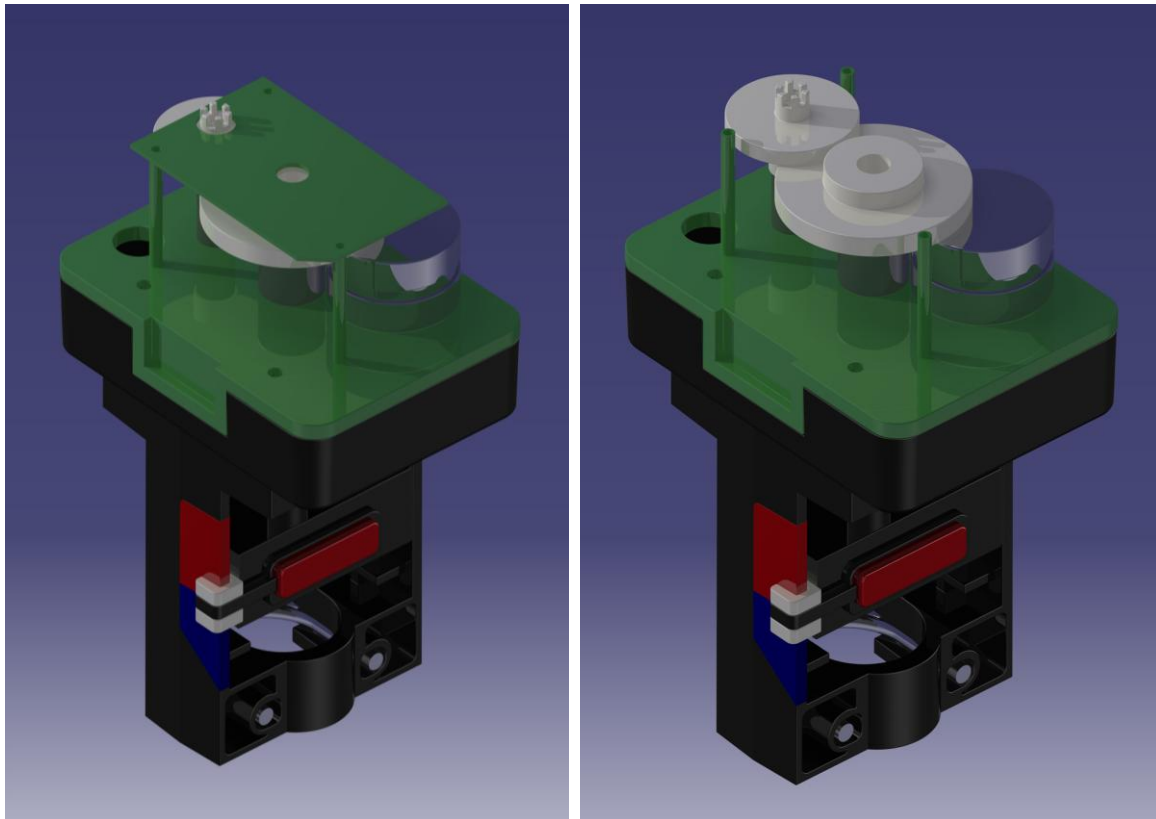

Figure 22 The placement of the inside components, with and without circuit board

Motor house design

As was stated in part 4.4 “The concepts”, the optimal shape of the motor house is rectangular since it manages to fit all the inside details such as motor, circuit board, sprockets etc. The motor house consists of three different parts - one white top lid made of plastic, including the manual adjustment tool and where the Regin logotype is placed, one green inner lid made of aluminium that should hold the motor parts together and that forms a green line around the product, and a chassis in black aluminium that helps with melting the top parts of the product into the bottom parts both with colour unity and with shape. The using of three colours – green, white and black helps in giving a solid and unison expression but still manages to make the part that should be prominent to stand out. One example of this is the green inner lid that when the top lid is on adds a linear feature to the lid and also implements the Regin colour green in a clear, yet discrete, way. The bent in the green line on both side of the lid give a clue to the user on where the top lid should be opened and also how it should be mounted again (the same principle used in a puzzle). These aspects helps increase the overall usability in the valve actuator. The inner lid also helps isolating the sensitive devises (motor, circuit board etc.) from dust that can get in to the product via the cable inlet holes.

The two holes for the electrical cables are placed on the motor house chassis, as they are on most other valve actuators on the market today. This placement also enables for the same working methods as the plumbers uses today, the same cable drawing and mounting.

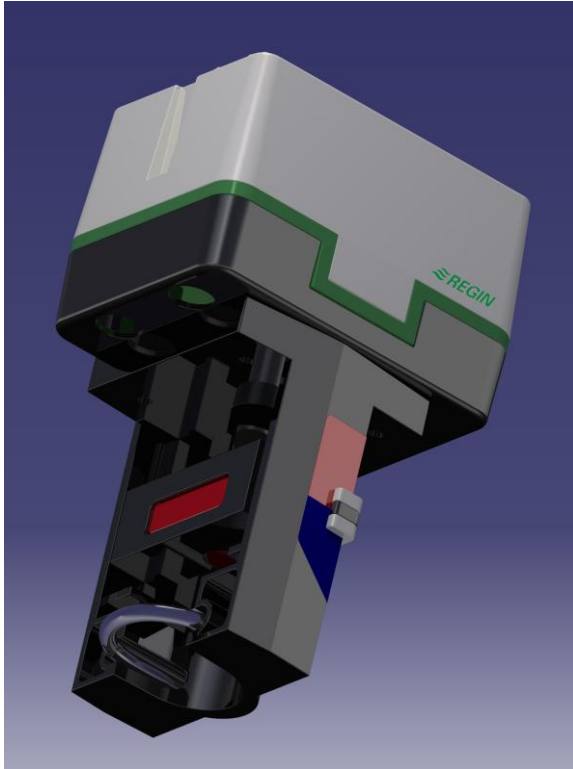

Figure 23 *The cable holes on the motor house chassis*

Manual adjustment tool

As was determined in the concept development the function and overall shape of the manual adjustment tool used in the RVA valve actuators is used also in the new valve actuator. The changes that were made was the location of the manual adjustment tool that was change from a cornered to a more centred position and the implementing of colour coding by colouring the button that is used to activated/deactivates the manual mode. These arrangements will hopefully help improving the usability in the new product.

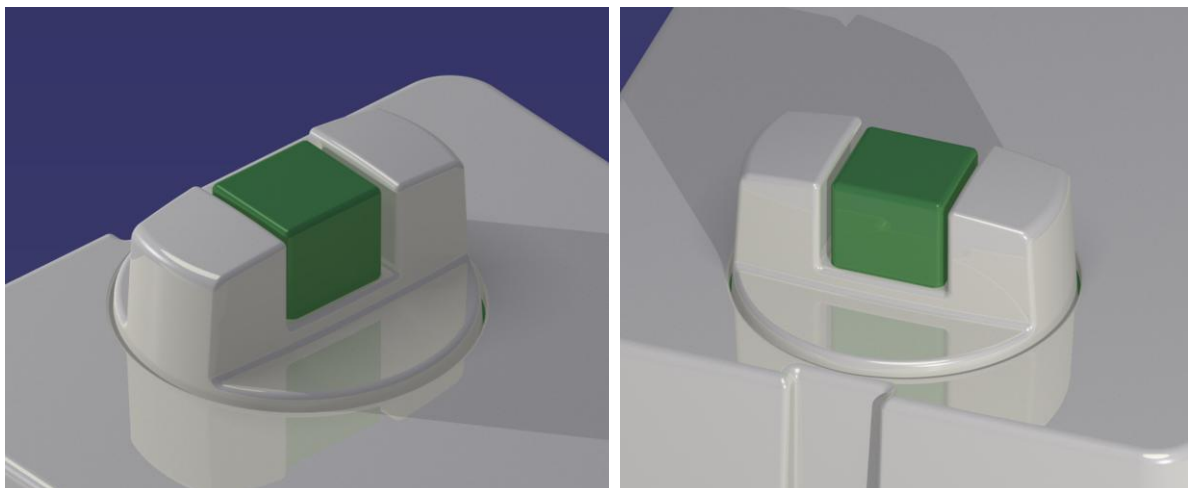

Figure 24 *Front and back view of the manual adjustment tool*

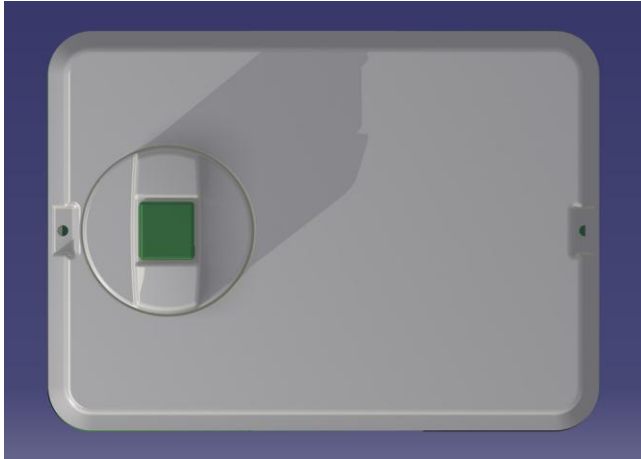

Figure 25 *Top view of the new valve actuator*

Spider locking principle

The spider locking principle is the one presented in part 4 “Concept development” and was the one that the reference group wanted to implement in the new product. As was stated earlier the new valve actuator uses the same locking principle as the RVA valve actuators, with the difference that the locking solution has been encapsulated to get a more solid expression and to be more comfortable to use. More specific the sharp edge of the locking in the valve actuators in the RVA series is change to a red button which is more comfortable and merciful to use. The body surrounding the red button is shaped to melt in to the rest of the machine body and made from the same material and in the same colour as the machine body. This part also includes the black measurer that shows the current location of the actuator. On the left side of the enclosure is a hole, making room for the measurers that are connected to the scale (see figure 26 *The scale, measurers and new spider locking solution for a heating devise*).

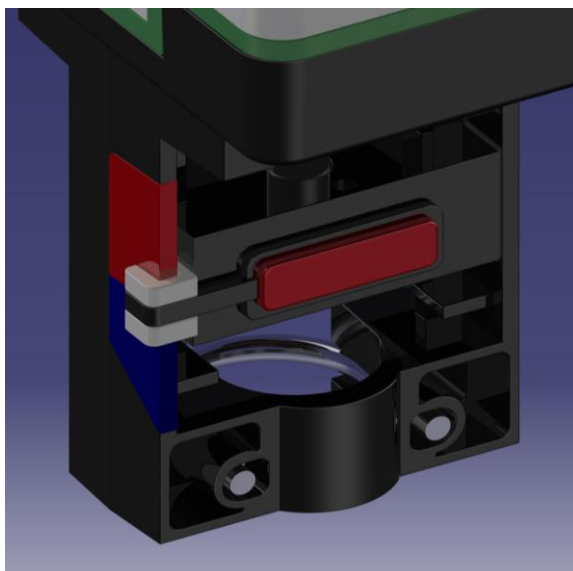

Figure 26 *The scale measurers and new spider solution for a heating devise*

To be able to fit the valve actuator to competitor valves a spider head is put on the top of the spider that is connected to the valve (see figure 27 *The existing adaptor for the RVA valve actuators*). This principle is already used in the RVA valve actuators and has been proven to work successfully.



Figure 27 *The existing adaptor for the RVA valve actuators*

Actuator-valve locking principle

As was mentioned in part 4.3.4 “Actuator-valve locking principle”, the U-shaped valve-actuator locking device is kept as on the valve actuators of the RVA series. The difference is that the machine body has been designed to close tighter around the U-shaped lock to eliminate losses.

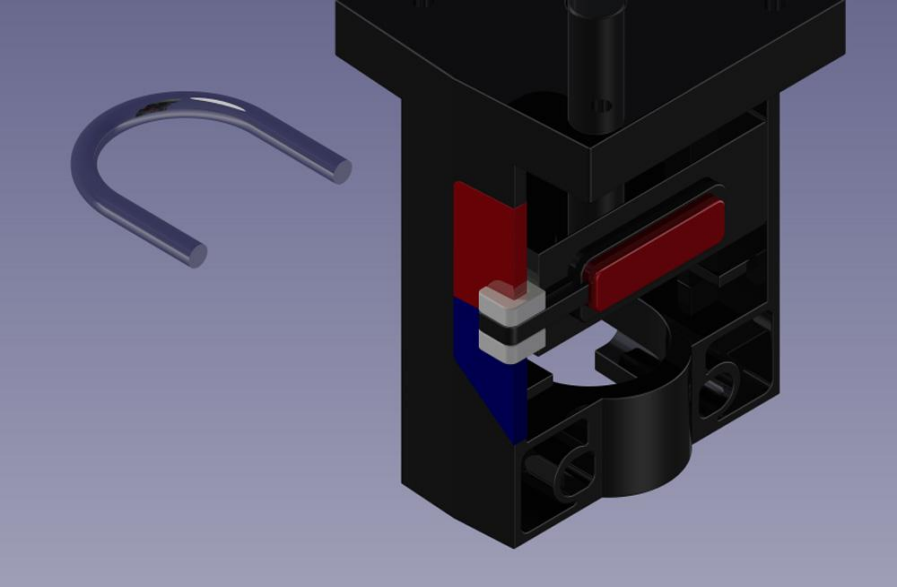

Figure 28 *The Actuator-valve locking principle*

Scale

The scale is shaped as a down pointing arrow that is divided in the middle by the colours red and blue. The scale is made like a sticker that is glued on to the left side of the machine body in the mounting face to get the correct zero point to in a correct way show the current location of the actuator. The appearance of the scale differs depending on if it is a heating or a cooling

device that the valve actuator is attached to. For a valve actuator attached to a heating device the scale is red at the top and blue in the bottom. The blue colour indicated that the valve actuator is closed and no hot fluid runs through the valves and red indicates that the valve actuator is open and the warmth is on. The higher up in the red area the more fluid and the warmer the building gets and the lower down in the blue area the less fluid and the colder the building. The choice of using red and blue for colouring was done to visualise the warmth generated by the actuator when the actuator is fully opened and the cold generated when the actuator is closed. The two colours should also be easily seen from a large distance, easily separated from one another and in a clear way show the current location of the valve actuator/help emphasize the three measurers attached to the spider and spider locking. For a valve actuator attached to a cooling device the colouring of the scale is opposite.

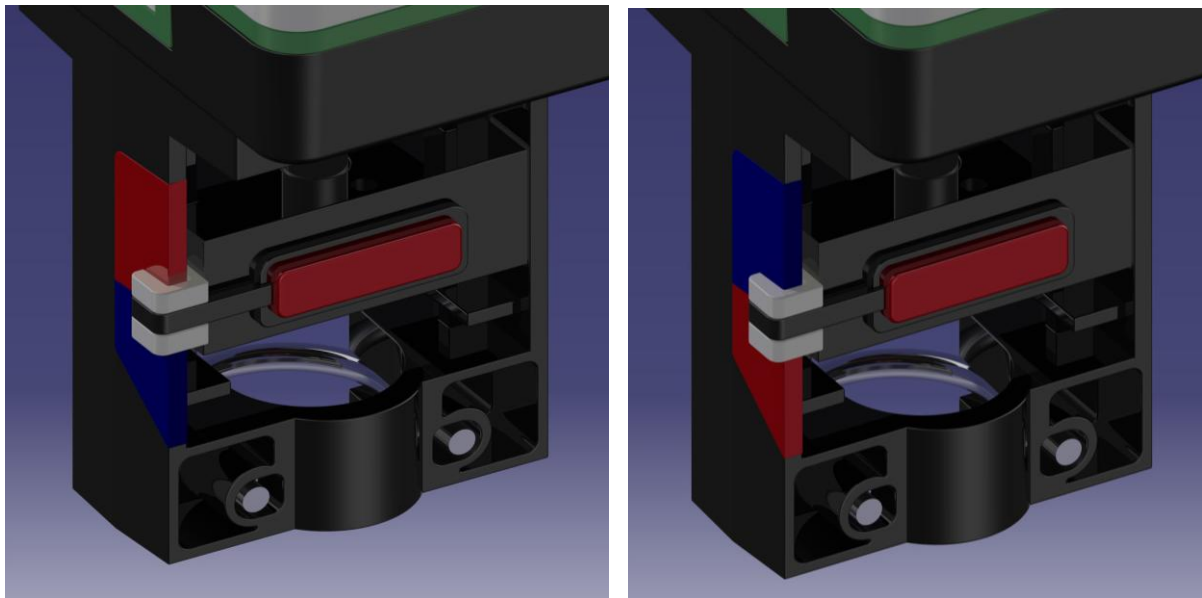

Figure 29 *The scale for a heating and a cooling devise*

As was mentioned earlier there are three measurers that comes with the scale, one black in aluminium that works in unison with the spider and that shows the current location of the valve actuator – whether the valve is opened or closed. On each side of the black measurer there is one white measurer that are wedged on the machine body and that moves up/down when the actuator changes location and that in this way show the maximum and minimum values of the stroke length. The colours of the measurers are chosen to enable for them to match the rest of the product design and also to make the measurers prominent towards both the scale and the machine body. The reason why the measurers should be prominent is to make the reading of the valve actuator simpler.

5.2.3 PRODUCT ASSEMBLY

In the exploded view of the product (see figure 30 *Exploded view*) you can see the modular design mentioned in part 5.2.1 “Product architecture”. All parts are connected with screws and gears except the scale which is glued on to the product. The number of screws has been minimized and the shape of the components has been made as simple as possible, with out to many double bent surfaces to simplify the manufacturing process.

The assembly of the product has been inspired by simplicity and usability. The aim was to make it clear where all the components should be mounted. The design was also made to make a spacious design where there should be no problem to assemble the component either with fingers or with a screwdriver or another tool. The product is also designed so that the final assembly that is done by screws and gears should be easy and accessible. The spider locking is assembled individually to then be mounted onto the machine body. The same goes for the top lid which is connected to the manual adjustment tool before it is assembled onto the rest of the product parts. In the final assembling the machine body is used as a base to mount the other components on. First the spider locking is mounted on to the machine body and the white measurers are added. In the next step the motor house chassis is assembled on top of the machine body, followed by the green inner lid, the beam, the motor, sprockets and circuit board and finally the top lid with the manual adjustment tool. In the last stage the U-shaped valve-actuator lock is placed on the bottom of the product.

In the mounting face, when the actuator is mounted on to the valve, the scale is added onto the machine body on a proper location adapted to the zero-position of the spider.

When it comes to recycling, the valve actuator is designed to make it easy to disassemble. This is done in the opposite order as the assembling. Since the product mostly involves large parts that are assembled with a low number of screws the disassembly process will be simple and done in a small range of time, i.e. the probability that the product will be disassembled instead of just burned in the large oven at Renova is large. The mix of materials in the new valve actuator has been minimized and the motor and circuit board, which are important to recycle, are also easily reached just by removing the top lid.

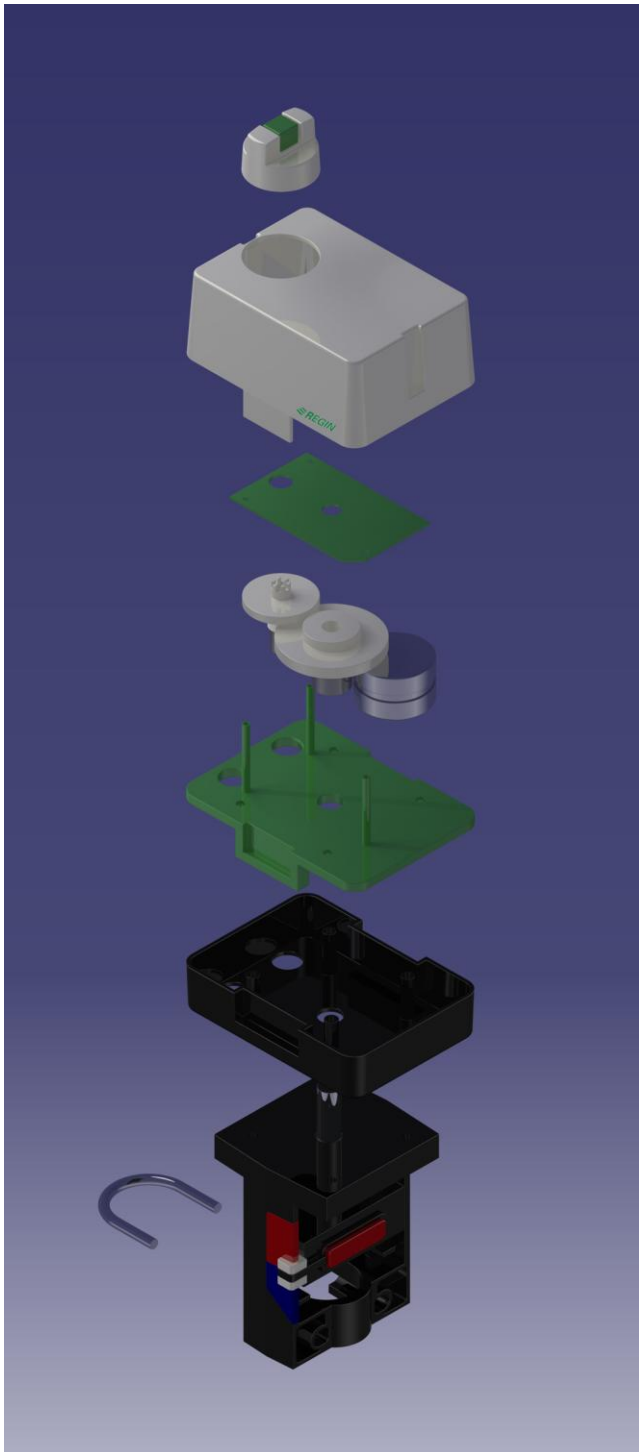

Figure 30 *Exploded view*

5.2.4 MATERIAL SELECTION

In general Regin AB tries to choose components that is good from an environmentally point of view but function (and in some aspects cost) is more important than environmentally friendliness since the product and the material used in the different components needs to work in the use situation without costing too much money. One example of this is aluminium that is used in the frame of the valve actuator. Aluminium is not an environmentally friendly material

but unfortunately one of the few materials that can be used in this kind of application. The rule of putting function before environmental friendliness is something that needs to be followed also in the material selection of the new valve actuator. The approach therefore is to stick to the materials used in the valve actuators of the RVA series if no other more suitable and environmentally friendly material can be found to a similar cost. Another reason for sticking to the same materials that are used in the RVA valve actuators is that these materials are familiar to the subcontractors who manufacture the different components for Regin AB, a fact that makes the whole manufacturing process of the new valve actuator simpler. Another reason for keeping the materials of the valve actuator RVA5-24 is that these materials have been selected to fit the demands put on them by the different parts. During the time when the valve actuator RVA5-24 has been used in the industry, Regin AB has performed tests of its wearability and functions and has not yet found any major problems with it. The conclusion of this is that the materials used in the valve actuator RVA5-24 are very suitable for the different partial functions in a valve actuator and that these materials are suitable to be used in the new valve actuator as well.

Regin AB do not manufacture their product components themselves, but buys them from subcontractors. The aim of Regin AB is to make the product easy to manufacture, assemble and disassemble to lower the total cost and production time of the product. To do so the number of components in the new valve actuator should be minimized, the shape of the partial components should be simple and in the same time functional and the shape of the components should have low number of double bend and other advanced curvatures.

Materials and colouring in the valve actuators of the RVA series:

Component	Material	Colour
House	Zn, Fe, Al, Si, Cu, Mg	White
Lid	ABS, POM (Polyoxymethylene)	Grey
Electrical motor	Plastic, Cu, Fe	No colour
Gear	POM (Polyoximetylen), Fibre glass	No colour
Shaft	SUS (Stainless steel), Fe	No colour
Screw, Nut and Bolt	Fe, Zn, SUS (Stainless steel)	No colour
House opening, plastic	NBR, POM (Polyoximetylen), Nylon66	No colour
House opening, metal	SUS (Stainless steel), Fe	White
PCB	Epoxy, Cu, Sn (Lead-Free)	No colour
Cardboard container	Corrugated cardboard	White

Materials in the new valve actuator:

Component	Material	Colour
Machine body	Zn, Fe, Al, Si, Cu, Mg	Black
Lid	ABS, POM (Polyoxymethylene)	White
Under lid	Zn, Fe, Al, Si, Cu, Mg	Green
Electrical motor	Plastic, Cu, Fe	No colour
Gear	POM (Polyoximetylen), Fibre glass	No colour
Shaft	SUS (Stainless steel), Fe	No colour
Screw, Nut and Bolt	Fe, Zn, SUS (Stainless steel)	No colour
Circuit board	---	Green
Markers, plastic	NBR, POM (Polyoximetylen), Nylon66	Red, black
Spider locking	SUS (Stainless steel), Fe	No colour
Valve-actuator locking	SUS (Stainless steel), Fe	No colour
PCB	Epoxy, Cu, Sn (Lead-Free)	No colour
Scale	Plastic	Red/blue

5.2.5 CHECK OF THE DEMANDS

Fulfilled demands (21/33 demands):

- E - Fit all Regin valves where this kind of actuator is used (32 p)
- Q - Have a spider locking device that fits the Regin spider (30 p)
- R - Allow different stroke lengths (28 p)
- U - Generate enough motor force (27 p)
- H - Be sellable/ able to stand by itself as well as together with other Regin products (25 p)
- I - Follow the Regin product identity (24 p)
- J - Follow German design criterions (23 p)
- AG - Be easy to locate in the environment it is used (17 p)
- AD - Be free from pointy or loose details (15 p)
- X - Be easy to install (14 p)
- G - Prevent failures in the mounting face (12 p)
- W - Have functional and usable manoeuvre functions (12 p)
- S - Minimize losses (12 p)
- F - Clearly show whether the actuator is open or closed (11 p)
- AC - Only have coatings where it's necessary for its function or its identity/expression (10 p)
- AF - Be easy to detach from its mounting position (10 p)

AB - Only be coloured where it's necessary for its function or its identity/expression (9 p)

L - Be easy to manufacture (8 p)

V - Be adaptable to different montage on different valves (8 p)

M - Be easy to assemble (7 p)

C - Be easy to reassembly (3 p)

Demands that needs further testing (9/33):

K - Fulfil the protection class of IP54 (31 p)

O - Have high impact resistance (28 p)

P - Manage the repulsive force generated from the valve (27 p)

Z - Withstand the different temperatures in the environment (22 p)

AA - Be able to use with different water qualities (21 p)

Y - Withstand rust and other outside damaging (dust, moist etc. (20 p)

T - Prevent leakage (17 p)

A - Have a maximum price of 600 SEK (13 p)

N - Have long wearability (9 p)

Demand that should be analysed more (2/33):

D - Consist of environmental-friendly components (2 p)

B - Consist of materials that are recyclable (1 p)

Demand that was not fulfilled (1/33):

AE - Allow outdoor use (0 p)

5.2.6 ECONOMIC ANALYSE

Since no strange features have been added to the new valve actuator compared to the old valve actuator RVA5-24 and since the same manufacturing processes could be used the product will not be more expensive in the long run. New moulds will have to be produced which will cost more in an early stage but the manufacturing and assembling of the process is simpler than the one before since the shape of the product is simpler, the numbers of screws are less and the product structure are more open/easier to reach. The fact that the new valve actuator will replace two other products with one manufacturing and assembling process each the whole economy of Regin AB will gain on introducing this new valve actuator. The conclusion is that even if the total cost of the new valve actuator will be more than 600 SEK in the first stage, this cost will be reversed in time and it will not be more expensive for Regin AB than to have two valve actuators in the product range.

6. DISCUSSION

6.1 DISCUSSION OF THE OVERALL MASTER'S THESIS WORK

The Master's Thesis work has been both interesting and a big challenge since it has forced me to be very substantial and functional in my solutions. The things that was presented to the company needed to be functional and truly considered also when it come to material selection and manufacturing methods to be accepted. The Master's Thesis work has also involved a lot of new knowledge about the valve-actuator area, the work performed on different instances at an industrial company and of how to structure and plan this size of work to be done in time and to get the final result that was aimed for. The hardest part with the project was to manage to fulfil all the demands that were put upon the new valve actuator and at the same time retain a creative and open mind in the design process. A valve actuator is a very technical product that consists of different mechanics that have to be there in order for the product to be fully functional. The struggle in the Master's Thesis work was to include all the necessary functions in the new valve actuator, give the actuator a new and improved design and make it associated with the other electrical valve actuators on the market so that it still looked as it belonged to the same product area.

When developing a technical product as a valve actuator you need to have the technical function, the aesthetics and usability, branding and material aspects in mind to manage to create a product that is accepted by the different people concerned with the product as well as the final users. When it comes to the product design it was interesting that the hypothesis that the German industry is strict and old fashioned were proven wrong and that the German representative at Regin AB had opinions regarding product design, usability and wanted core values for the new valve actuator that matched the vision that I had with the same product and that also matched the Regin design values very well. This agreement made the development process simpler and also made it easier to determine the design of the new valve actuator.

6.2 DISCUSSION OF THE COOPERATION WITH THE DIFFERENT PEOPLE INVOLVED IN THE MASTER'S THESIS

The collaboration between the different department and people at Regin AB, with the Reference group and with my supervisor at Chalmers have work well and uncomplicated, which has also helped the progress of the Master's Thesis work. The fact that Regin AB is a relatively small company with a tight organisation has helped a lot in reducing the lead lime in the different development stages such as delivery of reference and competitor products, visits to different departments, different questions that needed to be answered and different problems that needed to be solved. The fact that the co-workers at Regin AB also have been open and willing to tell me their opinions regarding different aspects along the project there was a lot of inputs during the whole product development process, which was very useful. The work process with the tight and continuous cooperation with the people in the reference group, where ideas and comments of the reference group were noted and considered in order to get a final product suggestion that matched the needs and criterions of the different department involved with the product and of the users who meet the valve actuator out in reality. This tight cooperation was really successful for this kind of product development where you have a

technical product with lot of boundaries that needs to be considered to be able to create a functional product that is accepted out in the industry.

6.3 DISCUSSION OF THE FULFILMENT OF THE OBJECTIVES

The main objective of the Master's Thesis was to develop a realisable product suggestion of a valve actuator that fulfils the demands that is put upon it from an economical, environmental, functional, image/identity, legal, manufacturing, performance, security, technical, usability and working environment perspective. All these aspects have been considered in the development of the new valve actuator and the criterions put upon the product from Regin AB, their co-workers, the users of the product and the markets where the product is going to be sold were translated into demands that the new valve actuator should fulfil. In this way all people involved got the chance to say their opinion of what the new valve actuator should look like a fact that also increases that probability that the new actuator will be successful on the market. When you look at part 5.2.5 "Check of the Demands" you can see that 21/33 demands are fulfilled, these demands concerns product functionality, product value and identity and usability and accessibility. 9/33 demands needs further testing to state if they are fulfilled or not, these demands concerns IP-classification, force, temperature, water and dust resistance as well as resistance of outside damaging, wearability and price. 2/33 demands, which concerns environmental aspects, should be analysed more in order to make the product solution even more optimized. Finally 1/33 demands was not fulfilled with the new valve actuator. This demand was that the valve actuator should be able to use outside, which is not the normal environment for the valve actuator and the reason why this aspect was not considered in the Master's Thesis. Since the valve actuator manages to fulfil the functional and esthetical demands put upon it and has been design to also cope with the wearability and resistance aspects the conclusion is that the solution is ready to be translated into a prototype to enable further testing that hopefully will prove that the new valve actuator fulfil the other demands as well.

The Master's Thesis has also managed to sort out which design features that appeal to the German market and included these features in the final design suggestion. The aim also was to develop a product that stands out from the competing products and that is true to the design values of Regin AB, something that has also been achieved. Whether the product manages to appeal to all the markets where it should be launched is something that will have to be shown later.

Last in the objectives you could read that the end result should be a product suggestion with mechanical, ergonomic and design solutions. Suitable material and manufacturing suggestions should also be made together with a ruff economical analysis. The final solution should be presented as a Catia V5 model. All this have been done and is shown in part 5.2 Final solution.

One goal with the product development was to find a gap in the valve actuator product range to enable for Regin AB to develop a product that was different from the other products on the market and that had a modern and technical feeling to it. Another goal was to find the customer demands that are not yet fulfilled in the existing valve actuators and to then fulfil theses with the new product suggestion. When you look at the valve actuators on the market today the new Regin valve actuator is more solid and feels more wearable and more deeply considered/developed compared to the others. The new valve actuator also manages to express

the Regin brand in a clear way both in colour and shape, which was also one of the objectives. If the new valve actuator enables Regin AB to rise above the competitors on the market and gain market advantages is something that has to be proven later when the product has been launched.

7. CONCLUSION

The main conclusion is that it is possible to develop a valve actuator that fulfils both the functional and esthetical demands put upon it from all the concerned people. It has also been stated that there are certain German values for this kind of product, but that these are quite similar to the ones of Regin AB and to the common ideas of how functional and usable product should look. The design values of the different areas are therefore possible to translate into a single product design.

In the thesis it was stated that the valve actuator area needs more modern and usability features something that has been implemented in the design of the new product. The research also showed a lack of design in the existing products which is something that need to be implemented more in the valve actuators of tomorrow and where the new valve actuator of Regin AB presented in this Master's Thesis shows one direction to go.

8. RECOMMENDATION

In order to obtain a complete product suggestion of a new valve actuator there are still some aspects that needs to be considered in the further development process for which there was no room in this Master's Thesis work.

One area that is left to analyse is the ceiling of the holes for the electric cables that needs to be design to prevent dust and water to get inside the product.

Another area for further development is the product container that today is a plain cardboard box without logotype and other design features. The good thing with this container is that it is cheep and environmentally friendly, but it do not help the product stand out from the competing products. A new container with an improved design could higher the purchase experience and raise the product value. The container should give a feeling that the product should be pressured and that it is valuable, expensive, technical, robust and modern.

Last it is recommended to produce a prototype to begin the testing of the product in the environment it should be used and under different conditions to in the end have a product that is ready to manufacture and launch on the market.

9. REFERENCES

Baxter, M. (1995). Product Design – Practical methods for the systematic development of new products, Cheltenham, Nelson Thornes Ltd, chapter 3 – The principle of product styling, pp. 31-59

Monö, R. (1997). Design for Product Understanding 1st ed, Stockholm, Liber, pp. 166

Nesbitt, B. (2007). Valves manual international: Handbook of valves and actuators 1st ed, Oxford ; Burlington, MA: Butterworth-Heinemann, chapter 12 – Actuators, pp. 279-310

Ulrich, T.K. & Eppinger, D.S. (2008). Product Design and Development 4th ed, New York: McGraw Hill, chapter 2 – Development Processes and Organizations, pp.11-32

Regin (2010a). Meet the Challenger in Building Automation, Sverige: Regin AB

Regin (2010b). Regin Catalogue 2010-2011 - Products and systems for building automation, Sverige: Regin AB

Regin (2010c). Valve & Actuators – For energy-efficient comfort heating, cooling, HVAC and domestic hot water systems Kv 0.25 – 310. Sverige: Regin AB

Regin (2010d). Ventilhandbok, Sverige: Regin AB

Regin (2010e). Instruction RVA5-24A, Sverige: Regin AB

Interviews with Reference group [2010-08-16 to 2010-12-16]

Reference group=

- Lennart Spiik, Development and Technology manager, Regin AB Kålleröd
- Mikael Johansson, Product manager, Regin AB
- Leif Brattsköld, CEO and Marketing manager, Regin AB Kålleröd
- Lasse Bornö, Corporate Sales Manager, Regin AB Kålleröd
- Per Sandström, Valve development engineer, Regin AB Osby
- Jimmy Hallberg, Valve development engineer, Regin AB Osby
- Mark Riccius, Managing Director and Product sales manager heating, Regin AB Germany
- Nicklas Eriksson, Production manager, Allelektronik

APPENDIX A – FUNCTIONAL ANALYSIS

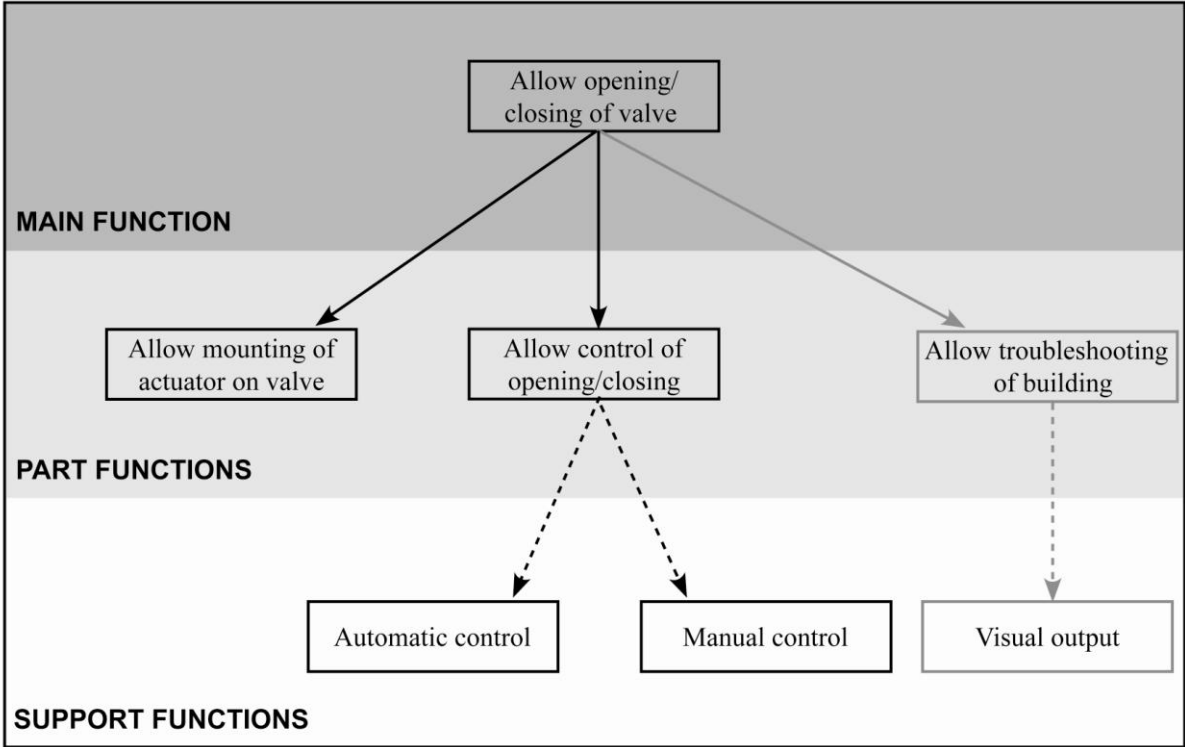

APPENDIX B – PRODUCT BOARD



APPENDIX C – REPERTORY GRID CHART

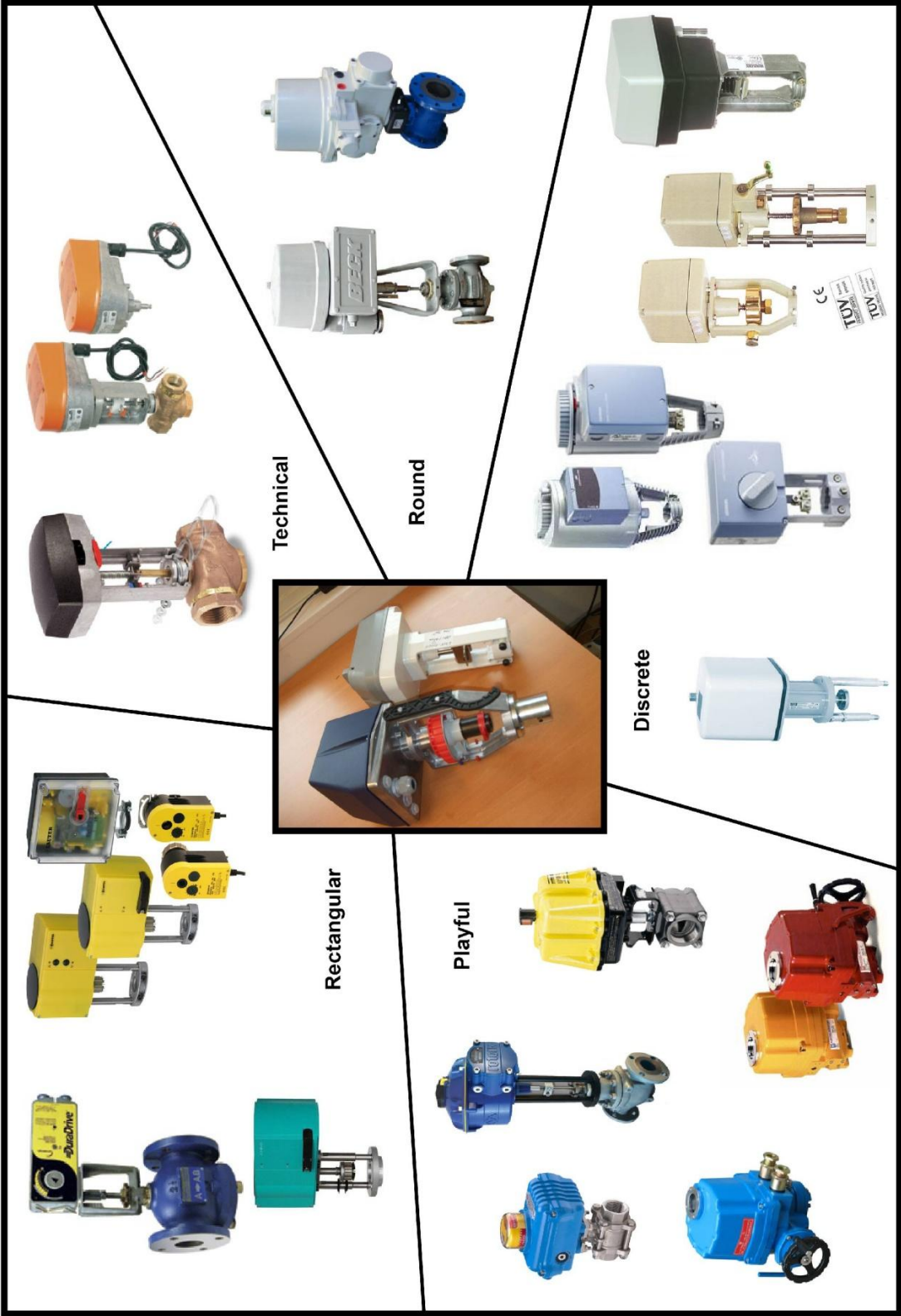

APPENDIX D – EVALUATED PRODUCTS

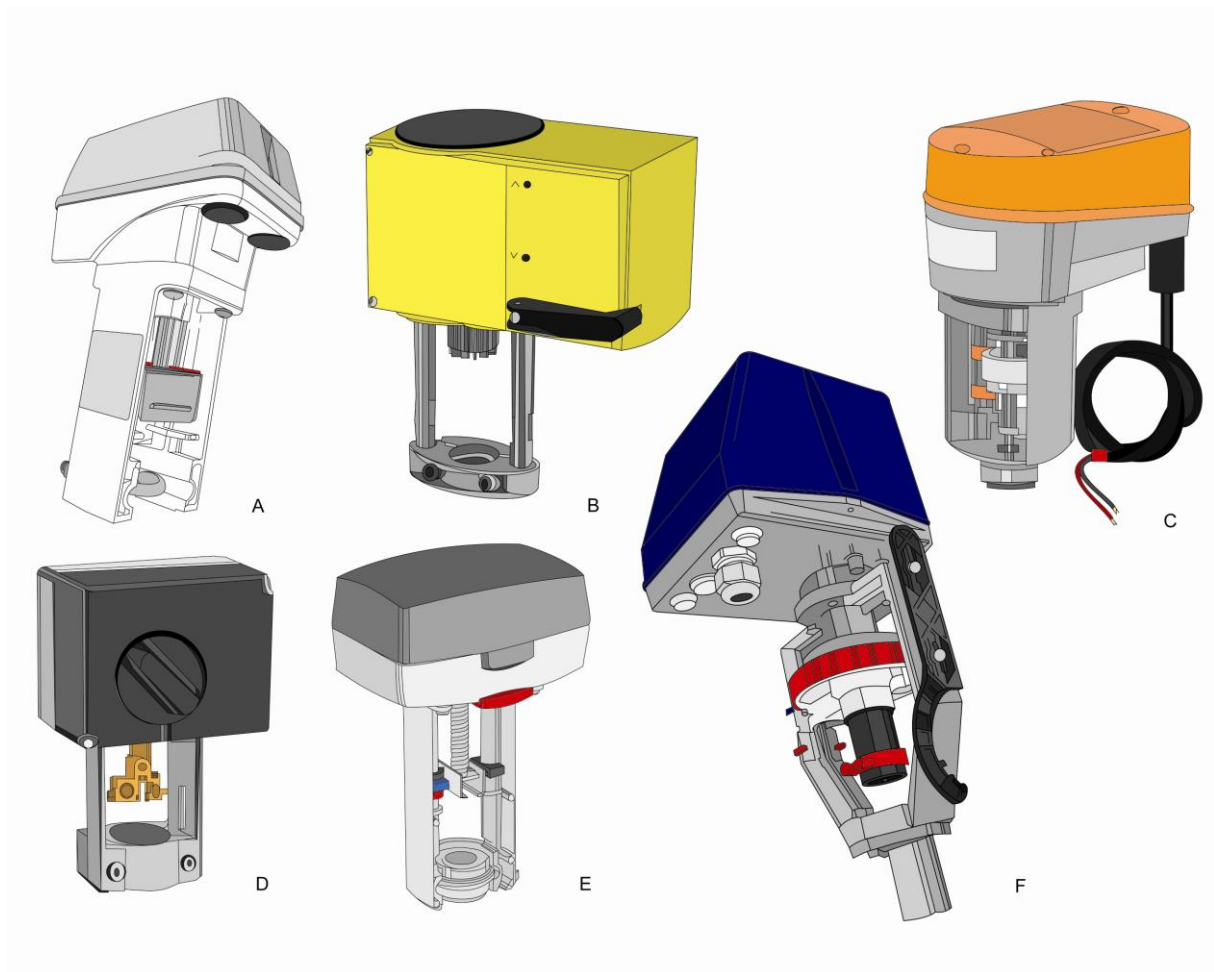

A – RVA, Regin

B – AVX, Sauter





























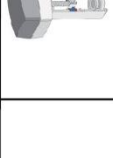





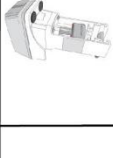



C – NVY24-MFT-R, Belimo

D – SQX, Siemens

E – Forta, Schneider

F – HM1150X, Regin

APPENDIX E – COMPETITOR ANALYSIS

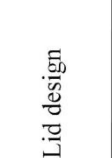
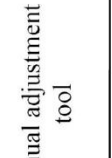
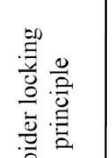
Product Area	HM1150X <i>Regin</i>	RVA <i>Regin</i>	Forta <i>Schneider</i>	NVY24- MFT-R <i>Belimo</i>	AVX <i>Sauter</i>	SQX <i>Siemens</i>
Overall design						
Framework						
Inside components						
Lid design						
Manual adjustment tool						
Spider locking principle						
Actuator-valve locking principle						

APPENDIX F – REGIN BRAND CHART

Colour



Shape and signature lines

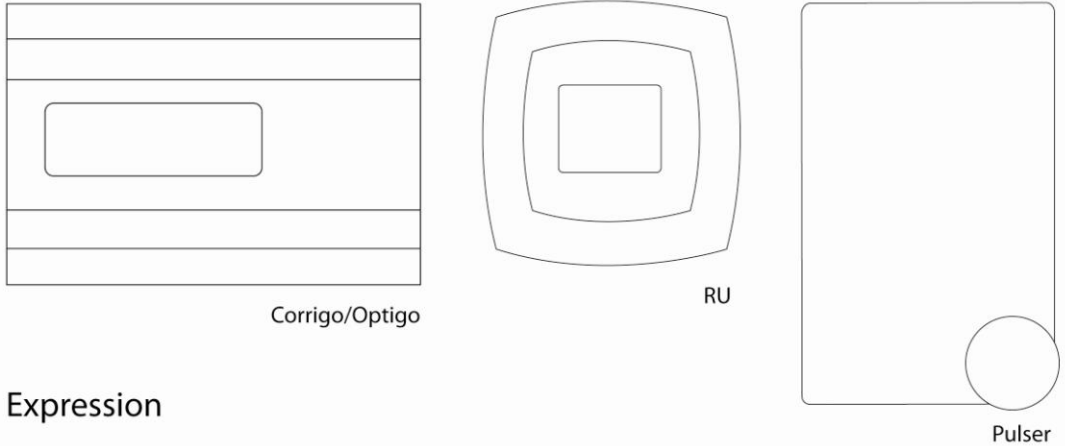

Expression

Clean
Functional
User-Friendly

Materials

Aluminum SUS - Stainless steel Iron Copper Zink Tin (Lead-Free) Magnesium Silicon	POM - Polyoxymethylene Fibre glass Epoxy Nylon66 NBR - Nitrile Butadiene Rubber
--	--

APPENDIX G – WEIGHTED DEMANDS

The first demand (demand 1) is the most important demand and the last demand (demand 33) is the least important. When two demands with same value their rate verses each other counts.

1. E - Fit all Regin valves where this kind of actuator is used (32 p)
2. K - Fulfil the protection class of IP54 (31 p)
3. Q - Have a spider locking device that fits the Regin spider (30 p)
4. R - Allow different stroke lengths (28 p)
5. O - Have high impact resistance (28 p)
6. P - Manage the repulsive force generated from the valve (27 p)
7. U - Generate enough motor force (27 p)
8. H - Be sellable/ able to stand by itself as well as together with other Regin products (25 p)
9. I - Follow the Regin product identity (24 p)
10. J - Follow German design crieterions (23 p)
11. Z - Withstand the different temperatures in the environment (22 p)
12. AA - Be able to use with different water qualities (21 p)
13. Y - Withstand rust and other outside damaging (dust, moist etc. (20 p)
14. AG - Be easy to locate in the environment it is used (17 p)
15. T - Prevent leakage (17 p)
16. AD - Be free from pointy or loose details (15 p)
17. X - Be easy to install (14 p)
18. A - Have a maximum price of 600 SEK (13 p)
19. G - Prevent failures in the mounting face (12 p)
20. W - Have functional and usable manoeuvre functions (12 p)
21. S - Minimize losses (12 p)
22. F - Clearly show whether the actuator is open or closed (11 p)
23. AC - Only have coatings where it's necessary for its function or its identity/expression (10 p)
24. AF - Be easy to detach from its mounting position (10 p)
25. AB - Only be coloured where it's necessary for its function or its identity/expression (9 p)
26. N - Have long wearability (9 p)
27. L - Be easy to manufacture (8 p)
28. V - Be adaptable to different montage on different valves (8 p)
29. M - Be easy to assemble (7 p)
30. C - Be easy to reassembly (3 p)
31. D - Consist of environmental-friendly components (2 p)
32. B - Consist of materials that are recyclable (1 p)
33. AE - Allow outdoor use (0 p)

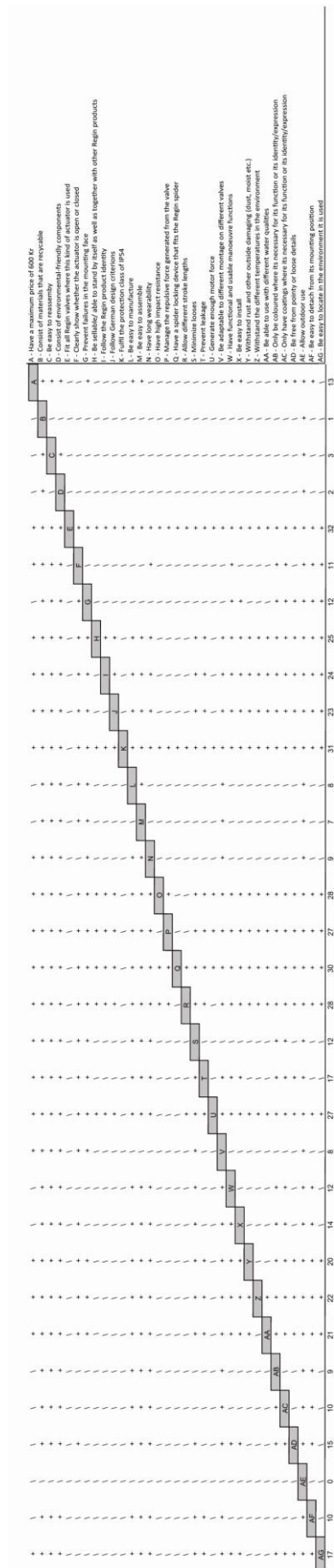

The picture show the weight chart where all the demands where compare in terms of

APPENDIX H – EARLY SKETCHES

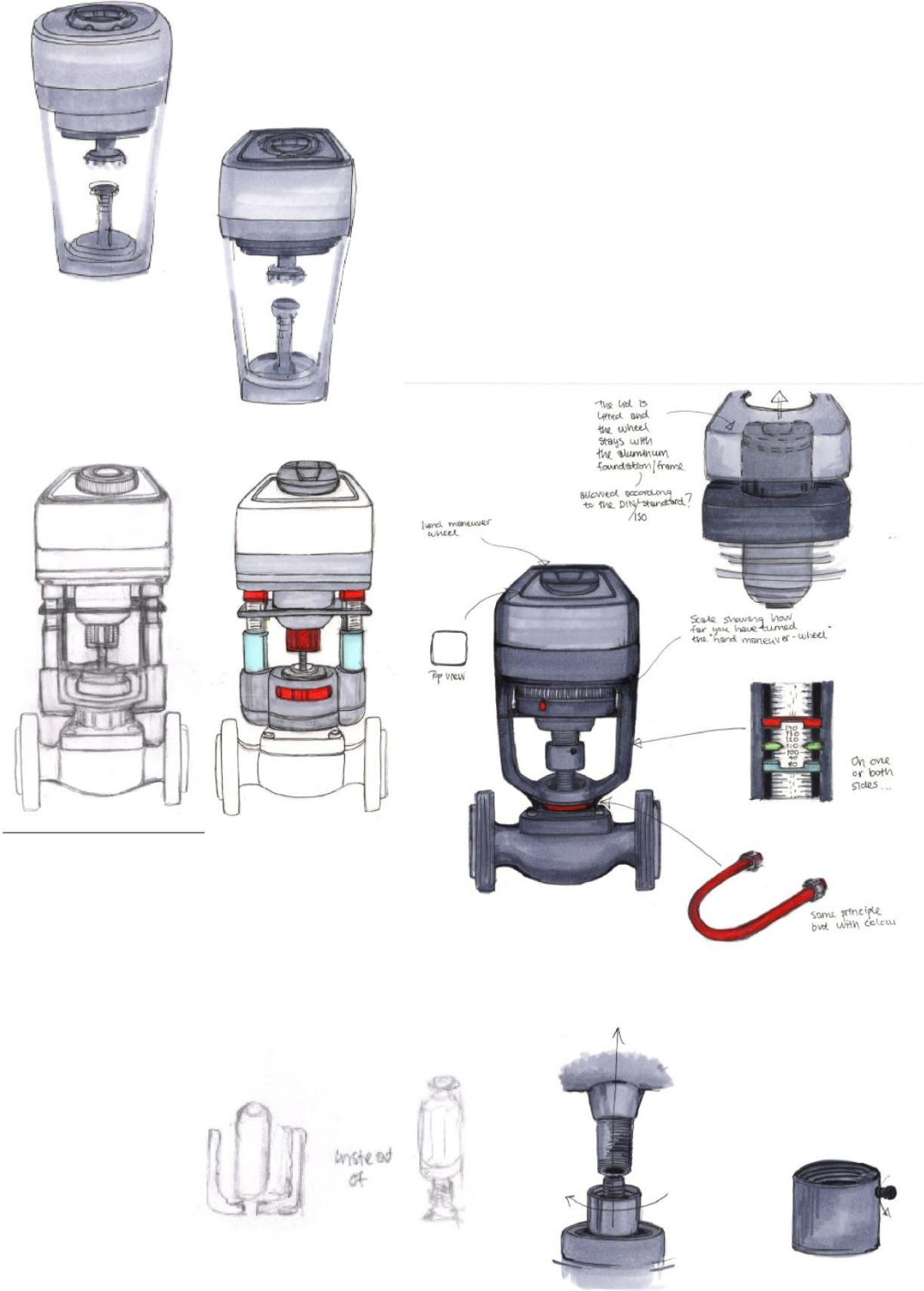

APPENDIX I – INSIDE COMPONENTS

TOP VIEW

(mm)

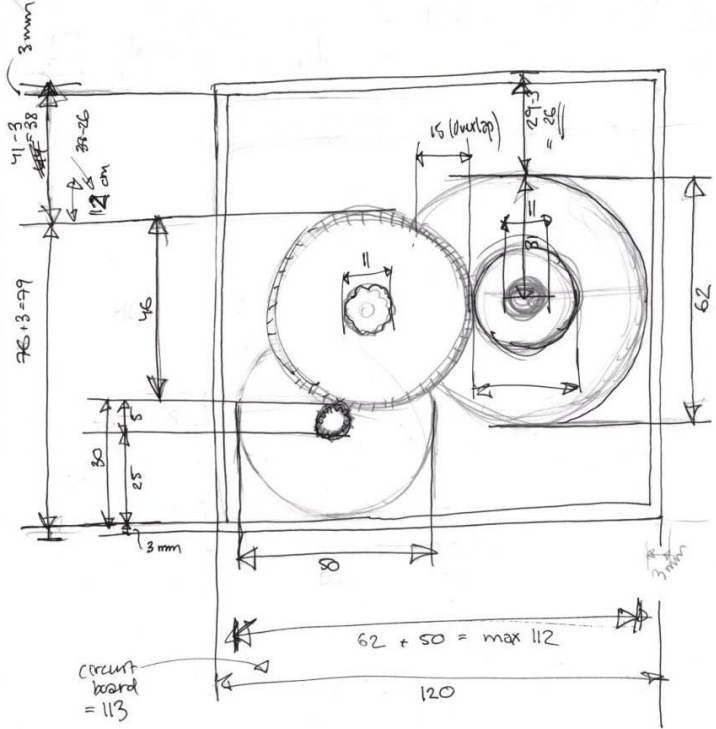

SIDE VIEW :

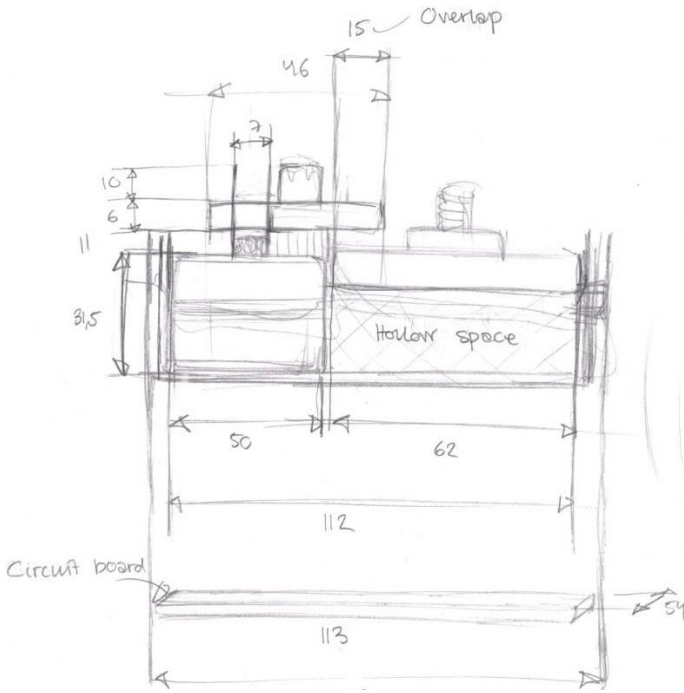

APPENDIX J – SHAPE ANALYSIS

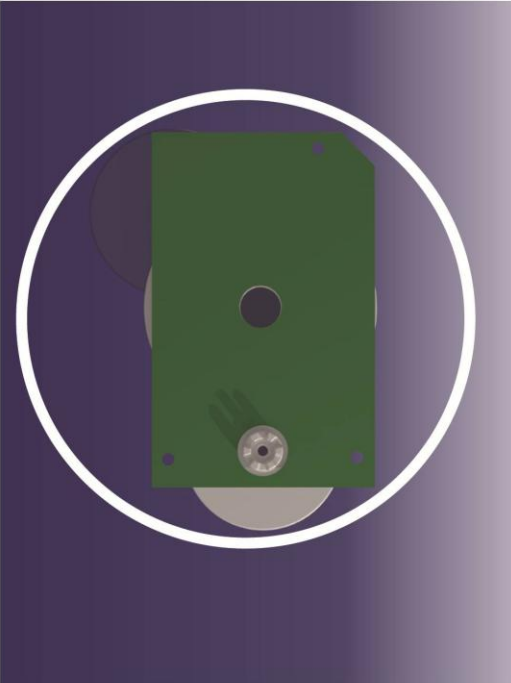

Circled

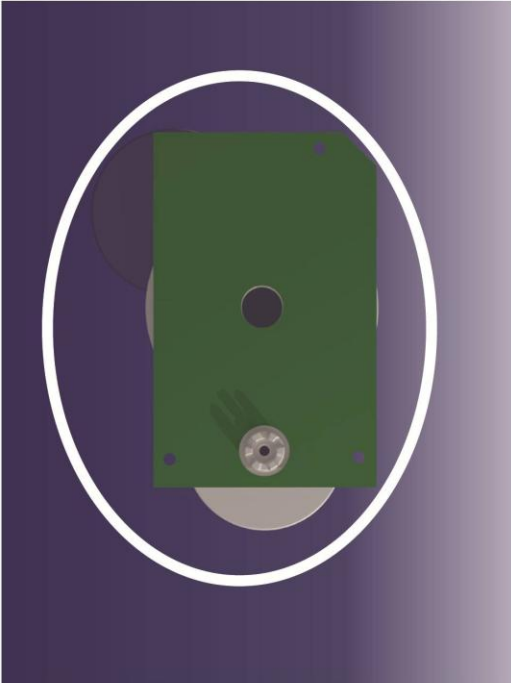

Ellipse

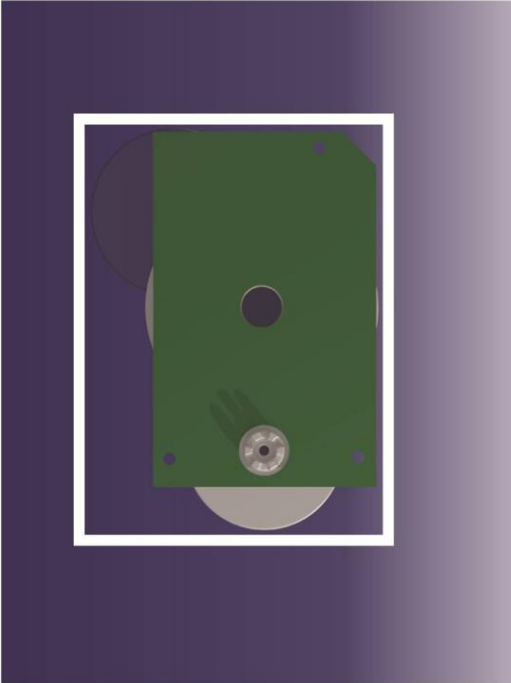

Rectangular

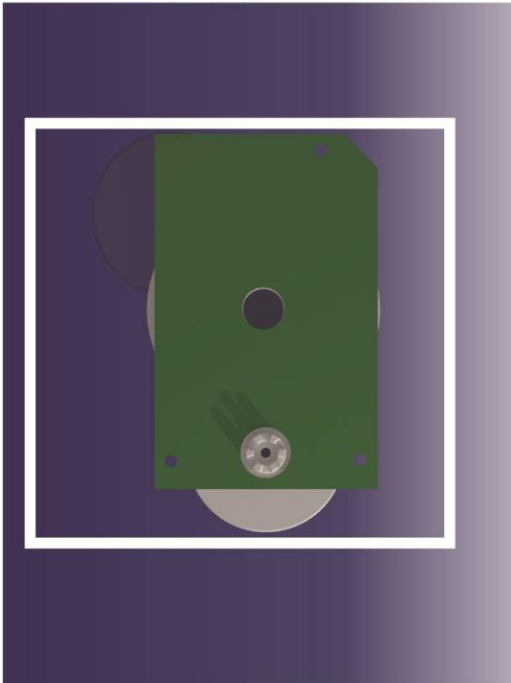

Square

APPENDIX K – NEW SPIDER LOCKING PRINCIPLE

