



Product guidelines developed within the areas of Design for sustainable behaviour, Green branding and Compact living

Visualized by a design concept of a coffee maker, a kettle and a toaster

Master of Science Thesis in the Master Degree Program, Industrial Design Engineering

MATHILDA BOKLUND LHONNEUR
IDA LINDÉN

Product guidelines developed within the areas of Design for sustainable behaviour, Green branding and Compact living

MATHILDA BOKLUND LHONNEUR
IDA LINDÉN

SUPERVISOR: ULRIKE RAHE

EXAMINER: ULRIKE RAHE

Master of Science Thesis PPUX05

Product guidelines developed within the areas of Design for sustainable behavior, Green branding and Compact living

Master of Science Thesis in the Master Degree Program, Industrial Design Engineering

© Mathilda Boklund Lhonneur and Ida Lindén

Chalmers University of Technology
SE-412 96 Goteborg, Sweden
Telefon +46(0) 31-772 1000

Cover photo: Ida Lindén
Print: Repro Service Chalmers

Abstract

This project was executed during the spring of 2016 as a master thesis at Chalmers University of Technology, at the Department of Product- and Production Development, Division of Design & Human Factors in cooperation with the company Electrolux in Stockholm.

New technologies creates new excess products that increase the energy consumption around the world. The design of future products therefore have a great impact on this effect. New trends with the desire to decrease these effects have raised an awareness of the challenges of global warming and compact living. Sustainable products is therefore becoming more common on the market but the field of sustainable small household appliances is still small. Therefore, this project focuses on Design for Sustainable Behavior (DfSB) and Compact living within small household appliances. By moving focus from green washing to Green branding companies can radiate sustainability in a more effective way and therefore the aim of this project also is to analyze the field of Green branding.

The deliverable of this project is guidelines on how to work with Design for sustainable behavior, Green branding, and Compact living within small household appliances, on a product series of coffee maker, kettle and toaster. The guidelines are summarized in a booklet that explains how a company can work with these areas by applying the guidelines to a product series of this kind.

The first part of the project, the pre-study, aimed to identify and investigate areas that are important when creating guidelines connected to Design for Sustainable Behavior, Green branding, and Compact living. The second part of the project, the idea generation, was a process with the goal to investigate how expressions and design cues can be brought to a product using guidelines. In the final part of the project, visualizations of the final concept in relation to the guidelines was made. A booklet for the company to use in their further development of sustainable products was also created.

The result of this project is a product series consisting of a toaster, a coffee maker and a kettle developed with focus on Design for Sustainable Behavior, Green branding, and Compact living. All choices in relation to development of the product series was motivated by using the guidelines. A conclusion is therefore that the developed guidelines within the fields of Design for Sustainable Behavior, Green branding, and Compact living can be applied to this type of product series.

The project also resulted in the insight that there is a need for sustainable products within small household appliances on the market today.

Preface

This project was executed during the spring of 2016 as a master thesis at Chalmers University of Technology. It was a 30 hp full time course that lasted during 20 weeks in cooperation with the company Electrolux.

The project was created and shaped together with Electrolux and Chalmers and focuses on product design of small household appliances within the area of Design for Sustainable Behavior, Green Branding and Compact living.

We want to thank our examiner and supervisor from Chalmers, Prof. Ulrike Rahe from the department of product- and production development, division of design and human factors. We also want to thank our extra supervisors, PhD candidate Anneli Selvefors and PhD candidate Maral Babapour Chafi for supporting us with their inputs and involvement during the project.

We want to thank Pernilla Johansson at the department of Small Appliances, Electrolux Group Design for giving us the opportunity to carry through the project at Electrolux, and Simone Gauss for supporting us through the project. A big thank you to the Electrolux team consisting of Esbjörn Svantesson, Simone Gauss, Fulden Dehneli, Kim Michel and Martin Kwarnmark who supported us on the workshop held at Electrolux.

We would also want to thank our opponents Sofie Andersson and Johan Hagejård for giving us valuable feedback on the report and relevant inputs of the project.

Table of Content

1. Introduction	8
1.1 Background	9
1.1.1 Problem description.....	10
1.1.2 Aim.....	11
1.1.3 Purpose	11
1.1.4 Research questions	11
1.1.5 Deliverables.....	11
1.1.6 Limitations	12
1.1.7 Report structure	12
1.2 Company description.....	13
2. Method and process.....	15
2.1 Process overview	16
2.2 Methods.....	17
PART 1	19
Pre-study.....	19
3. Theoretical Frame of Reference	20
3.1 Design for Sustainable Behavior (DfSB).....	21
3.2 Green branding	28
3.3 Technology overview	29
3.3.1 How the products function	29
3.3.2 The reference products	35
4. Investigations	38
4.1 Design form Analysis, DFA.....	39
4.1.1 Explicit design features of Electrolux	39
4.1.2 Findings	42
4.2 Benchmarking	43
4.2.1 Part one - Sustainable products	44
4.2.2 Part two - unsustainable features.....	45
4.2.3 Part 3 - Electrolux sustainable products	45
4.2.4 Part 4 - Competitors	47
4.2.5 Findings	51
4.3 Focus group.....	52
4.3.1 Part one.....	52
4.3.2 Part two	58

4.3.3 Part three	63
4.3.4 Findings	63
4.3.5 Discussion	63
4.4 User studies	64
4.4.1 Survey.....	64
4.4.2 Interviews	67
4.4.3 Customer journey mapping	70
4.4.4 Personas.....	75
4.4.5 Usability tests	80
4.5 Trend analysis	86
4.5.1 Findings	89
4.6 What a designer can change	90
4.6.1 Categorization	91
4.6.2 Findings	91
4.6.3 Discussion	91
4.7 Disassembly	92
4.7.1 Findings	92
4.7.2 Discussion	92
5. List of guidelines	93
5.1 Design for sustainable behaviour guidelines.....	94
5.1.1 Expressions.....	94
5.1.2 Measurement system	94
5.1.3 Use.....	95
5.1.4 Feedback.....	95
5.1.5 Motivation	95
5.1.6 Durability	96
5.1.7 Energy consumption.....	96
5.1.8 End of life	97
5.1.9 Disassembly.....	97
5.2 Green branding guidelines	97
5.3 Compact living guidelines.....	98
6. Discussion, Part 1	99
PART 2.....	102
Idea generation	102
7. Idea generation, first part.....	103
7.1 Important insights, basis for concept development.....	104
7.2 Intentions with the idea generation	105

8. Idea generation	106
8.1 Focus areas	107
8.1.1 Service system.....	107
8.1.2 Measurement system	108
8.1.3 Energy saving system by reusing energy	109
8.1.4 Incorporating thermos functions	110
8.1.5 Reduced handles.....	111
8.1.6 Carafe	112
8.1.7 Slim design.....	113
8.1.8 Connected products	113
8.1.9 Puzzle	115
8.1.10 Mutual parts.....	116
8.1.11 Focus areas	117
8.1.12 Comparison, focus areas and personas.....	118
8.2 Workshop 1	119
8.2.1 Findings	120
8.2.2 Discussion	124
9. Concept generation.....	125
9.1 The concepts.....	126
9.1.1 Concept one.....	126
9.1.2 Concept two.....	129
9.1.3 Concept three.....	134
9.1.4 Concept four	139
9.2 Workshop 2	143
9.2.1 Findings	145
9.3 Discussion	148
10. Final concept- How to apply the guidelines to a product series.....	149
10.1 The product series	150
10.1.1 The coffee maker.....	150
10.1.2 The kettle.....	151
10.1.3 The toaster	151
10.1.4 The measurement system	152
10.1.5 The app solution	153
10.1.6 The cord solution.....	153
10.1.7 The Collection	154
10.1.8 The collection in relation to the personas.....	154
10.1.9 Benefits with the concept	156

10.1.10 Future challenges.....	157
10.2 The booklet.....	158
10.2.1 Design for sustainable behaviour guidelines.....	158
10.2.2 Green branding guidelines	178
10.2.3 Compact living	182
10.3 Evaluation.....	186
10.3.1 Trend analysis	186
10.3.2 Geneva emotion wheel	189
10.3.3 Semantic word scale.....	190
11. Final discussion	192
12. Final conclusion	194
13. References	195
Appendices	203
Appendix I.....	204
Appendix II	206
Appendix III	211
Appendix IIII.....	223
Appendix V	230
Appendix VI.....	233
Appendix VII.....	237
Appendix VIII	246
Appendix IX.....	256

1. Introduction

This chapter gives an overview over the project by describing the project background, the problem description, purpose and aim. The research questions are stated along with the limitations and the deliverables of this master thesis. The chapter also includes a report structure and ends with a company description.

Chapter 1 contains the following subchapters:

1.1 Background

1.2 Company description

1.1 Background

New technologies on the market creates a desire to buy more products than really needed which results in higher energy consumption and waste around the world (Dobbs et al. 2012). The possibilities of decreasing the effect on the energy consumption curves with sustainable products have made future product design and development an important trend amongst many companies. The trend is a result of people getting aware of the challenges of global warming and the likelihood of many people living on less area per person, compact living (White et al. 2004). It is also a result of the combination of increased standards of living in the emerging economies thus entering the consumer society, together with urbanization, a continuous trend leading to ever growing large and mega cities (Dobbs et al. 2012).

Sustainable products such as washing machines, refrigerators and electric cars is today common on the market but the field of sustainable products within the small household appliances is yet small.

The approach of this project therefore lays in the area of Design for Sustainable Behavior (DfSB) within small household appliances. The project focuses on development of guidelines within the fields of DfSB, Green branding and compact living and how to visualize these with a concept of a product design.

The project was performed in cooperation with the company Electrolux in Stockholm, Sweden, which have taken these sustainability trends seriously and have a focus on the environmental impact of their products (Electrolux 2016f). This makes Electrolux one of the companies in the forefront of the development within this area.



Figure 1.1: Example of sustainable products

This project was executed during the spring of 2016 as a master thesis at Chalmers University of Technology. It was a 30 hp full time course that lasted during 20 weeks.



Figure 1.2: The Electrolux logotype



Figure 1.3: The Chalmers logotype

1.1.1 Problem description

Today, coffee makers, kettles and toasters can be found in almost every household in Sweden and one or more of them are being used on a daily basis. Since the products are used frequently the user's behavior in the use-phase will have an impact on the energy consumption of the products. Therefore both behaviors and energy consumption will contribute to how sustainable the use-phase and the products are.

Compact living is affecting everyday products, such as kitchen appliances, when more and more people live in big cities on less area per person. This results in the importance of products not taking up too much space in the household and new ways of thinking and living will be necessary in the future (White et al. 2004). If products with the same capacity get smaller it will result in less materials used, which is a positive sustainability aspect.

Companies today have a responsibility for the electric equipment's that they produce and put on the market. But many companies do not take their products back after their end of life, instead they recommend people to leave them at recycling stations (*Vinnande återvinning* 2016) (*Elektronikåtervinning* 2016). The recyclability of the products are affected by material choices and the possibility to disassemble them. People today do also throw away functioning products that could be reused or put on the second hand market.

Sustainability is to a great extent seen as a competing factor for companies today, but in the future it might be a prerequisite for them to stay on the market. Companies starting to focus on sustainability today will have an advantage over companies that do not. It is always beneficial to work proactive, and not reactive to become more profitable on the market (White et al. 2004).

Many companies today work unconsciously with greenwashing of their products when trying to express sustainability. This is mostly done by using features such as the color green, leaves or trees to symbolize that they are sustainable. These features do not mean that they actually are sustainable, it has rather become a way to express sustainability by visual appearance (*Greenwashing index* 2016). By instead working with Green branding companies can radiate sustainability without greenwashing. If focusing on this instead the company can gain more trust from the users when the appearance and the products correlates.

1.1.2 Aim

Since coffee makers, kettles and toasters can be found in almost every household in Sweden, and the user's behavior in the use-phase will have an impact on the energy consumption, the aim of this project was to investigate the everyday use of these products. This was done by focusing on design for sustainable behavior, green branding and compact living.

Sustainability has become a competing factor amongst many companies today. Therefore the aim of this project was to develop guidelines that helps the company Electrolux in their work towards sustainable products and green branding. This was done by assigning the results onto their products and still keep the values that Electrolux stands for.

Since people are living more compact today products will have to be designed to meet the new demands of smaller households. This has an impact on how the products are designed and therefore the aim was to analyze how a breakfast collection consisting of a coffee maker, a kettle and a toaster could be re-designed to gain a compact living approach.

1.1.3 Purpose

The purpose of this project was to analyze the topics Design for Sustainable Behavior (DfSB) and Green branding. It was also to analyze how the two can be applied on a series of kitchenware products within small household appliances to encourage a sustainable behavior with focus on compact living.

1.1.4 Research questions

To carry out the project in the most advantageous way four research questions was stated.

- Can guidelines within the field of Design for Sustainable Behavior be developed and applied to a collection of coffee maker, kettle and toaster?
- Can guidelines within the field of Green branding be developed and applied to a collection of coffee maker, kettle and toaster?
- Can guidelines within the field of Compact living be developed and applied to a collection of coffee maker, kettle and toaster?
- Are there any coffee makers, kettles or toaster on the market today that encourages a sustainable behavior?

1.1.5 Deliverables

The deliverable of this Master's Thesis was developed guidelines on how to work with Design for sustainable behavior, Green branding, and Compact living on small household appliances to encourage a sustainable behavior amongst users.

The guidelines was presented at the final presentation at Chalmers University of Technology and was strengthened and visualized by a concept series that illustrated the guidelines and the work behind it.

The deliverable was also a booklet of summarized guidelines that explains how the company Electrolux can work with Design for sustainable behavior, Green branding, and Compact living when assigning this to their products. The guidelines are strengthened by using the concept series that shows how the guidelines can be applied on small household appliances. The booklet was given to the company after the project was presented.

The result is also presented in this written report that will give the reader and the company deeper knowledge about the research and how the project work has been executed. Less developed concepts are also presented in the report.

1.1.6 Limitations

Before the project started, a number of limitations were stated to frame the detail level of the project. The limitations are listed below.

- The details of technology was not developed and no new technology was to be invented. The concepts had to be based on existing technology or be built upon them.
- The manufacturing processes and the materials used in the final concept was only discussed briefly based on their impact on the environment and from a design aspect, but a deep analyze and research was not made. The cost was not considered at all.
- Graphical design or packaging was not a part of the project and the level of details in the finish design was not in focus.
- The concept focused on to the European market and mainly Sweden.

1.1.7 Report structure

This report consists of thirteen chapters, each with a short introduction to its content, for the reader to better understand the context. After the introduction chapter, chapter 1, where the aim and background along with a short presentation of the company is to be found follows chapter 2, presenting the methods used during the project. All through the report each method will be described in more detail in relation to its result. The report is further divided into two parts, Part 1 and Part 2. Part 1 consists of chapter 3 to 6, starting with chapter 3, a thorough theory chapter presenting the areas of DfSB, Green branding and a subchapter about how the products function. In chapter 4 all investigations made during the project are presented consisting of a benchmarking, form analysis, focus groups and user studies along with a trend analysis, a categorization and a disassembly. Each parts starts with a description of the method used followed by findings and a short discussion about the method. Chapter 5 sums up all results from Part 1 in a list of guidelines followed by chapter 6 where the results are discussed.

Part 2 consists of chapter 7 to 10, where chapter 7 is an introduction to the idea generation part summing up the findings from Part 1. The following chapter, chapter 8 presents the findings from the first idea generation and workshop 1 with focus on potential focus areas for the project. Chapter 9 consists of the first concept generation presenting four different concepts and workshop 2 where the concepts are further discussed and evaluated. The final chapter in Part 2 is chapter 10, which starts with presenting the final concept series followed by a description about how the guidelines developed in Part 1 has been applied to the concept series.

If the reader's main interest is the result from the project, chapter 10 gives a good presentation of this. For better understanding of the result the whole report should be read but especially Part 2.

The final discussion can be found in chapter 11 followed by chapter 12, final conclusions. Chapter 13 is the list of references. If the reader is curious to get complementary information about methods and results this can be found in the Appendices.

1.2 Company description

Electrolux is a company with a Scandinavian heritage and with its headquarters in Stockholm, Sweden (Electrolux 2016j). The company was founded in 1919 and is formed by its corporate culture that built upon three different main pillars. Those are *Respect and Diversity* where the mix of cultures and functions within the organization is important along with respect for the individuals within the company. *Ethics and Integrity* which shows in their transparency and *Safety and Sustainability* where they want to support a sustainable environment which also is incorporated in all parts of the organization (Electrolux 2016a) (Electrolux 2016b).

Electrolux's core values is to work with *Passion for innovation* where they strive for new solutions in different ways. *Customer obsession* where they take the consumer needs in consideration in their design and *Drive for results* where changes are visible and measurable (Electrolux 2016a).

The company has a great market and many brands around the world such as Electrolux, AEG and Zanussi (Electrolux 2016c), where the brand Electrolux is the greatest and most well-known (Electrolux 2016d). Their global market can be divided into two parts depending on whether the market is a mature or a growth market. The mature market is characterized by replacement products since the population growth is low. In a growth market the standards of living are rising, making more and more households able to invest in different appliances and household products (Electrolux 2016e). Measured by customers, stakeholders and employees Electrolux wants to be leaders and the best appliance company in the industry (Electrolux 2016c).



Figure 1.4: The Electrolux brands

Electrolux work with design, innovation and a big customer focus to meet the needs of the users in the best ways (Electrolux 2016j) and they have a great knowledge about their area. Their sustainable design focuses on the product's environmental impact of the whole lifecycle, from manufacturing to reuse of material (Electrolux 2016f). The sustainability focus Electrolux have today comes from their sustainability strategy where resource efficient solutions are of value and a way to build trust towards customers by their transparency (Electrolux 2016g). For Electrolux it is important to make smart material choices by choosing materials that are recycled, recyclable and resource efficient. The materials should be used in the best possible way to reduce the environmental impact. Waste is constantly being reduced and handled after local regulations (Electrolux 2016h). Electrolux also supports energy labeling of products which is a way of convincing customers that energy efficiency is an important part of choosing products. It is also a way of communicating the efficiency and cost savings to customers (Electrolux 2016i).

2. Method and process

This chapter will give an overview of the process and the methods used during the project. The process overview will give an insight of how the project had been executed and the methods during the pre-study will give an insight in the methods used in the early phases of the project. The methods used during the idea generation and concept development will give an insight in methods used in the creative process.

Chapter 2 contains the following subchapters:

2.1 Process overview

2.2 Methods

2.1 Process overview

The first part of the project was the pre-study with purpose to identify and investigate areas that are important when creating guidelines connected to Design for Sustainable Behavior, Green branding, and Compact living. Beside those areas the importance of the users and the context of the products was identified. These factors functioned as a base for the guidelines. This process is illustrated in figure 2.1.

The second part of the project was the idea generation process with the goal to investigate how expressions and design cues can be captured using the guidelines and be transferred onto a product. The concepts were evaluated by design students and the company to find the best concept that shows the guidelines. This process was an iterative process with focus on the developed guidelines and has been illustrated in figure 2.2.

The final part of the project was to visualize the concept in relation to the guidelines and create a booklet for the company to use in their further development of sustainable products. This process was an iterative process with focus on the developed guidelines and has been illustrated in figure 2.3.

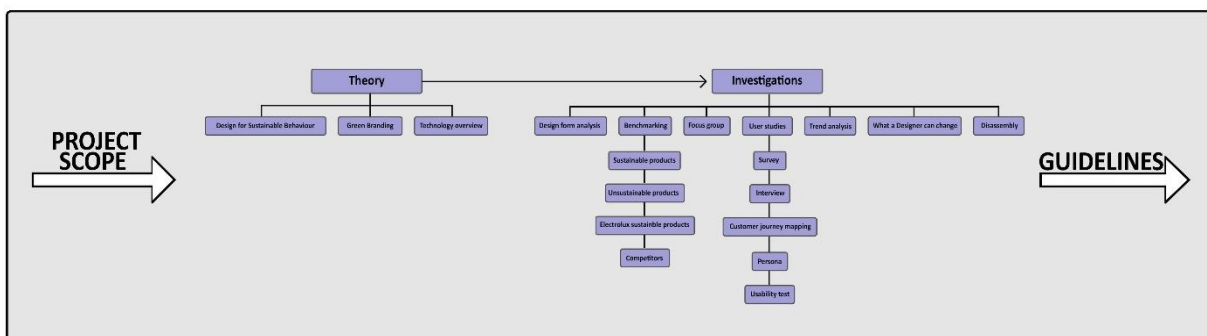

Figure 2.1: The process, Part 1

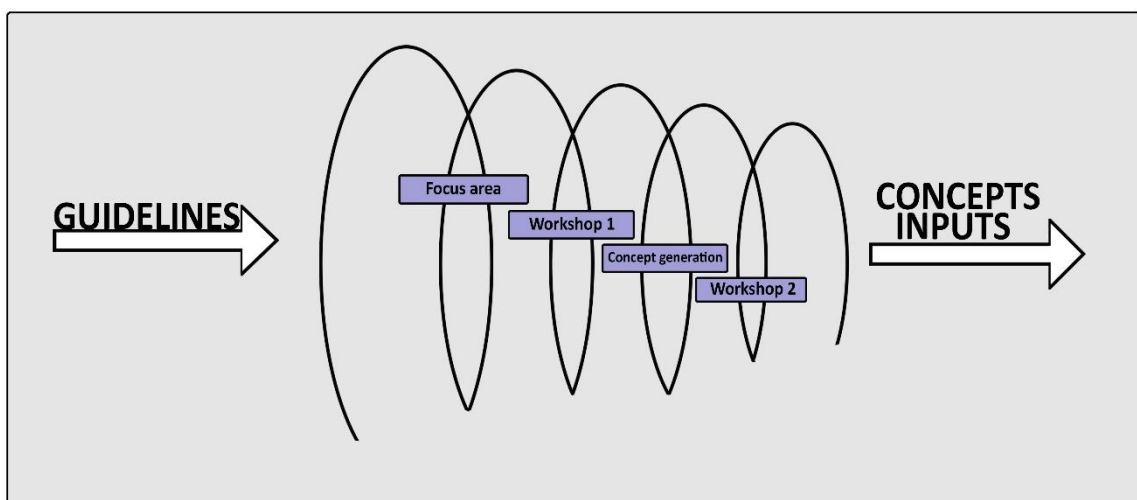

Figure 2.2: The process, Part 2

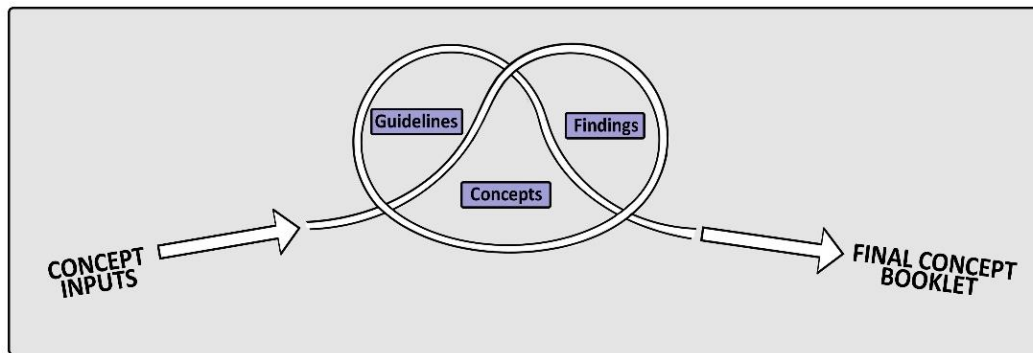

Figure 2.3: The process, final part

2.2 Methods

Methods used during part 1, pre-study

Methods used during part 1 of the project has been summarized in the table below.

Benchmarking	A benchmark was made to become aware of the existing products on the market today along with old products and future products.
Focus group	To strengthen the findings from the benchmarking, a focus group was held around sustainable and unsustainable expressions of products.
Design form analysis	A design form analysis (DFA) of Electrolux design features was made to be able to capture their design language.
Survey	A survey was conducted to gather information about how a general breakfast collections is used today.
Customer journey mapping	A customer journey mapping was made to visualize how the different products are used and to locate possible critical areas during use.
Personas	Three personas were made to communicate the user needs and behaviours. They were used as a way of exemplifying user patterns and to describe the target users and were based on user research.
Interviews	Semi structured interviews were conducted face to face with questions connected to the products, behavioural change and feedback. The interviews were held to confirm answers from the survey.
Usability test	A usability test was made to analyse existing products.
Trend analysers	A trend analysis was made to analyse existing products on the market, old- and future products.
What a designer can change	This categorization was used to categorize different aspects related to artefacts and was used during the project to be able to identify relevant aspects from a design for sustainable behaviour perspective and to sharpen the focus areas.
Disassembly	To visually understand how the product's function a disassembly was made to understand and find the difficulties during this part of the product's lifecycle.

Table 2.1: Methods during Part 1

Methods during part 2, idea generation and concept development

Methods used during part 2 of the project has been summarized in the table below.

Brainstorming	This method was used during the whole projects. It consisted of quick hand made sketches combined with discussions to generate a large quantity of ideas quickly.
Association method	This method was used to challenge and push the participants towards new ideas. The association method is a way of stimulating an imagination to achieve something constructive by writing or sketching (Johannesson et al. 2004).
Idea shift method	This method was used to bring new eyes and views into the project by using six Industrial Design engineering students. The group was given a problem description with the goal to come up with solutions to a certain problem.
Workshop 1	This workshop was held to gain more inspiration to the concept development and was carried out with six design students.
Workshop 2	This workshop was held at Electrolux together with a design manager, a global project manager, a product design intern, a product designer and a technical expert/development engineer.
Mock ups	Quick mock ups were made to reflect ideas and functions. It was also a way to analyse the ideas to find problems and issues with the concepts.
Evaluation	By using the sketch models and handmade sketched the concepts and ideas could be evaluated and analysed after each method used. The concepts was evaluated through discussions, comparing to guidelines, other people not included in the project giving more insights and through Catia V5 to evaluate volume.
Focus area	To decide focus areas for the project meetings were held with both the company and supervisors. Inspired by the results from earlier work during the pre-study a brainstorming session was made. The main objective of this session was to identify potential focus areas for continued work.
Comparison - focus areas and personas	To connect the focus area and the personas, the focus areas with statements were placed on a board according to how they influenced each other or was connected to each other. The pictures of the personas were then placed next to the clustered statements in relation to attributes that the personas valued in their products.
Visualisation	The guidelines were visualized using a concept series developed during the project. First visualisation was made using line sketches, and later on Photoshop and InDesign. After Part 1, the pre study, more detailed models were made in Alias V5.

Table 2.2: Methods during Part 2

PART 1

Pre-study

3. Theoretical Frame of Reference

This chapter aims to give an overview over the literature studies made on the design theories Design for Sustainable Behavior (DfSB) and Green Branding. The literature studies worked as a base and inspiration during the entire project. The literature regarding DfSB and Green branding was gathered through a literature study of scientific articles related to the topics. This chapter will also give an introduction to how the products (coffee maker, kettle and toaster) functions and the reference collection used in the project will be presented.

Chapter 3 contains the following subchapters:

3.1 Design for Sustainable Behavior (DfSB)

3.2 Green branding

3.3 Technology overview

3.1 Design for Sustainable Behavior (DfSB)

A new way of thinking when it comes to design and sustainability is to design for a sustainable behaviour. To be able to do this in a good and efficient way it is important to understand behaviours, what it is that affects them, and how they can be changed.

Behaviours can be affected by different factors that can be divided to personal-, societal and activity related factors. The personal factors are connected to how you are, and why that makes you act in a certain way. Factors connected to this area are beliefs, personal norms, knowledge, skills and financial situation. The societal factors are factors such as social norms, climate, market, physical and structural environment, legislation and regulation, societal players. The activity related factors are everyday goals, artefacts, habits, context and social context (Selvfors, 2014).

These factors along with several other factors that influences behaviours are presented more specific below.

Routines

A big part of behaviours is routines (Selvfors et al. 2011). These are difficult to change, but if wanting to change a behaviour they are important to reach (Selvfors, 2014). New functions and technology will increase the possibility of changing routines, and if a product is designed to make everyday life easier, the chances of changing an already existing routine will increase (Selvfors et al. 2011).

Habits

There are different types of behaviours amongst humans, but the most electricity-consuming activity is the habitual behaviour. It is made by regularly made decisions meaning that if something, a service or a product, makes a user save time and that do not take a lot of effort when making the decisions it does so by habits (Fischer, 2008). How to best change a habit is by a contextual change (both social and physical environment) and/or education (Nilsen et al. 2008).

The context

Contexts will affect behaviours (Selvfors et al. 2015) (Selvfors, 2014). According to Manning (Strömberg et al. 2015) it is important to understand the context that the product is used in. If a designer understand the context, he or she can affect the use of resources by changing the behaviours (Strömberg et al. 2015) through the design. The context can affect the energy consumption whether or not the user is engaged in energy saving activities (Selvfors et al. 2015). Manning in (Selvfors, 2014) also mentions that all behaviours are depending on the situation. This means that it does not matter if people are motivated to behave in a certain way if the contextual factors does not match the behaviour. According to this, people can be locked into unsustainable behaviours even if they want to be sustainable in their actions (Selvfors, 2014).

When talking about contextual factors affecting behaviours, people often mean external factors and circumstances such as situational factors, products and services, and infrastructure. In this case the design could help to enable and facilitate a sustainable behaviour instead of hindering it. In a case where the contextual factors strongly enables for a sustainable behaviour people do not need to be motivated to still perform the behaviour in a sustainable way. This means that the best way to use contextual factors to facilitate for a sustainable behaviour is by naturally integrate them in people's everyday life by means of technology and activities (Selvfors, 2014).

Barriers

The possibility for sustainable behaviours to arise will increase if people have few barriers against the sustainable action. Examples of barriers could be lack of infrastructure, an extra expense, and lack of knowledge, the difficulty of breaking a habit, psychological or social issues (Lidman & Renström 2011).

Norms

Behaviours are affected by people's norms (Lidman & Renström 2011). To break habitual patterns the norms must change. According to the literature there are different types of norms. One category is personal norms that are based on personal ideas. The other category is social norms that is based on what other people think. It is difficult to change the way people perceive their norms and the norms can often conflict with each other. This makes a person validate different aspects and a through process of different factors that may affect the belief. These factors can be moral, environment, costs and benefits and can be affected by all new information the person gets. This process can become a habit and a routine (Fischer, 2008).

Motivation

Motivation is a factor that can make people change a behaviour. According to Steg and Vlek (Selvfors et al. 2013b) this could be motivational factors that are connected to how people reason around attitudes, values, morals and norms, contextual- and habitual factors (Selvfors et al. 2013b). According to the literature motivation is important when investigating why people do or do not perform a certain behaviour. It might also be that another behaviour is prioritized prior to an energy saving behaviour (Selvfors et al. 2015).

According to Selvfors there are two types of motivations:

1. The motivation that *“assumes that people make choices by weighing the costs and benefits of different alternatives. one example of such a rational choice model is “the Theory of planned” behaviour (Tpb) based on”* Ajzen in (Selvfors, 2014).
2. The motivation that *“focuses on the motivational role of people's’ values and environmental beliefs, environmental concern, moral obligations, and the influence of social norms”* (Selvfors, 2014)

According to Selvfors et al. in (Selvfors et al. 2011) there are four approaches on how to awake motivation in relation to decreasing resource consumption, see figure 3.1. These are:

1. Increasing user knowledge in relation to a particular situation or product
2. Engage the user

3. Spur in different ways that triggers motivation
4. Increasing attention in specific situation or during action (Selvfors et al. 2011)

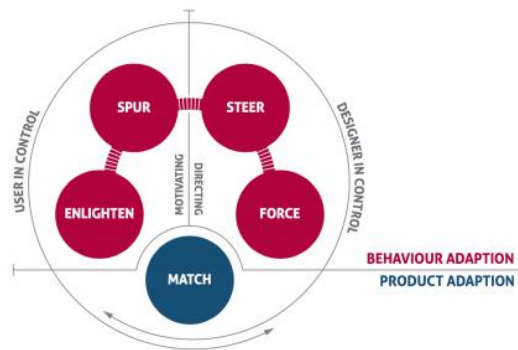

Figure 3.1: Approaches on how to awake motivation (Selvfors et al. 2011)

People's motivation will change depending on what they prefer in different situation (Selvfors, 2014). Other things that can work as motivators are: comfort, relaxation or efficient work organization (Fischer, 2008).

Feedback

One area that can motivate a more sustainable behaviour and that is well researched is the area of feedback (Fischer, 2008). Feedback has three main functions, these are:

Learning function, for example to learn about the connection between the amount of energy used and energy consuming behaviours.

Habit formation, putting something learnt into practice resulting in a change of a routine habit.

Internalization of behaviour, after developing a new habit attitudes will change with time to suit the new behaviour.

(Wood & Newborough, 2002)

Bertoldi et al. in (Selvfors et al. 2013b) believes that it is possible to reduce the energy consumption by using energy efficient household equipments but energy consumption can also be influenced by behavioural changes according to Hertwich in (Selvfors et al. 2013b). To reduce the energy consumption among households, feedback is an effective way to use and the interactive computerized feedback is the most effective according to Fischer and Wallenberg et al. in (Selvfors et al. 2013b). According to Darby and Fischer in (Selvfors et al. 2013b), between 5-12% of the energy consumption could be saved by using feedback systems. A feedback system concerning energy, more awareness and knowledge about the amount of energy used is obtained according to Grønhøj and Thøgersen in (Selvfors et al. 2013b).

The feedback has to be provided to the users through a channel that the user feel comfortable with and are used to, a channel that fits their habits. This means that energy feedback systems are not for everyone due to barriers in relation to technical and practical aspects, lifestyle

choices, and motivational factors. Only when feedback is given to the users in a form that they can adapt to, the users can engage in the feedback and are willing to change their energy consumption (Selvfors, 2014) (Selvfors et al. 2013b).

There are different forms of feedback which could be beneficial in different situations.

Those can be:

- Direct feedback
- Indirect feedback
- Inadvertent feedback

These are the best when it comes to raising awareness and result in changes concerning energy consumption. Direct feedback is more visible and encouraging.

There is also:

- Utility-controlled feedback
- Energy audits.

(Selvfors, 2014)

Fischer states that feedback is most effective when it is given on a daily basis or even more often (Fischer 2008). Feedback should also be given under a long period of time, give the user appliance specific data and be presented in a way that fits the user to work as efficient as possible. Grønhøj & Thøgersen, Darby and Abrahamse et al. in (Selvfors, 2014) means that feedback should be provided to the users continuously and through interactive technologies. The feedback should also give the user an insight into what consequences specific behaviour have (Fischer 2008) (Selvfors, 2014).

Goals

The approach to energy saving behaviours can be goal-oriented, since different goals can compete and affect the user in different ways. For example a user might want to save energy but is not willing to compromise his or her comfort (Selvfors et al. 2015). There are different kinds of goals. The non-active goals, the focal goal and background goals. What frames the goals can be hedonic-, gain- and normative goals. These three focuses on different things:

- Hedonic goal frame focuses on pleasure and excitement and avoids effort and negative emotions, which means that this frame builds upon the fact that people are sensitive to things that decreases their pleasure. People will also be sensitive to things that affects their mood in a negative way. This goal is related to the satisfaction of basic human needs and therefore it is assumed to be the strongest. In relation to pro-environmental behaviours, this goal is the least investigated.
- Gain goal frame is about people seeking improvements of personal resources or people seeking prevention of their resources decreasing. Resources can be different things for different people, for example economic or social (social meaning positive or negative approvals from others).

- Normative goal frame is about people being sensitive to what others and themselves thinks a person is supposed to do and what others are actually doing. One example is that people might actually recycle household waste because “it is the right thing to do”.

(Renström & Rahe 2013)

These frameworks can be used to change behaviours since they are assumed to affect a person's accessibility of attitudes and thereby influences how people evaluate their behavioural alternatives in different situations. This means that people's motivation will vary in different situations depending on what they prefer at that specific time. For example a person might in a specific situation prioritise a gain goal, meaning that he or she is prioritizing to improve their resources. If the person instead prioritizes a normative goal, the most important thing in that situation will be to act appropriate and if a hedonic goal is prioritized the most important thing will be to attain immediate satisfaction. It is the normative goal that most often encourages pro-environmental behaviours if active. The gain and hedonic goal-frames are less likely to result in pro-environmental behaviours (Selvfors, 2014).

Conflicts

Trying to change the way people perceive their norms can be difficult, and the fact that norms can conflict with each other might make a person validate different aspects. A process of different factors such as moral, environment, costs and benefits, may affect these beliefs and can affect all new information you get. This process can become a habit and a routine (Fischer, 2008).

People can experience that it is hard to engage in energy saving activities due to “*lack of support from societal players and measures limited to inconvenient and arduous options*”. A common reason for people not engaging in energy saving activities is that they experiences conflicts between competing everyday goals. People can be less willing to prioritize energy conserving behaviours in different situation. Implicit goals such as to reduce effort, increase well-being and reduce time misspent are factors found to often conflict with people's goal of saving energy. Events that might be seen as common strategies for saving energy such as turning of the light or leaving appliances on standby might save some energy but not be the most efficient solutions. This is because of the fact that these actions might prevent people from carrying out other everyday goals (Selvfors, 2014).

Comfort

Different goals can compete and affect the users in different ways, for example a user might want to save energy but is not willing to compromise his or her comfort (Selvfors et al. 2015). Gatersleben and Crosbie & Baker in (Selvfors, 2014) writes about the fact that people most often do not mind minor changes to reduce energy consumption but if these changes mean that they have to compromise with their comfort, freedom or/and pleasure people are less willing to make those changes (Selvfors, 2014).

There are differences between high consumption households compared to low consumption households in relation to how much thermal energy that is used and the use is three times higher

in the earlier case. This has to do with that higher comfort levels are more usual today (Renström & Rahe 2013).

Artefact

Another thing that might affect whether or not people engage in energy saving activities is the artefact (Selvfors et al. 2015). Decisions connected to a product can be very dependent on the design and functionality of the product. This means that the design and functionality of a product affects the potential of decreasing energy consumption behaviour. One example is the poor light quality of LED lights resulting in slower adoption of the product. People tend to not prioritize energy-efficiency over other parameters such as aesthetics, functionality and price (Selvfors, 2014).

Time

Time is an important aspect when it comes to behaviours since behaviours can vary over time (Wood & Newborough, 2002) (Selvfors et al. 2015) (Selvfors, 2014). Making sure that the energy saving activities does not take longer time or have higher demands on the users than the non-saving activities is important to reassure that they will be performed. For example to turn a product off becomes unworthy if the start-up time is too long (Selvfors et al. 2015).

Information

Another way to make people change their behaviours is to give them information. This can also be applied in relation to sustainable behaviours (Lidman & Renström 2011). Sustainable ways of choosing energy consumption can be either the choice of artefact or the choice of electricity that are renewable. The energy consumption do not start with the use of electricity but it starts with the need and purchase of new products using energy (Fischer, 2008). There are different factors that affect the adoption to the change and according to Rogers (1995) in (Selvfors, 2014) some of them are influenced by the characteristics of the innovation, the channels used for communication, the social system in which the innovation is introduced and the time period from first introduction until adoption or rejection (Selvfors, 2014).

There are different ways to analyse the information given and how it is given to the user.

Below is a list of different types of information:

- Information Concerning Environmental Issues
- Instructions for Sustainable Behaviour
- Highlight Benefits of Sustainable Behaviour
- Highlight Negative Environmental Impact
- Emotionally Triggering Information
- Engaging Information
- Simple Information

(Lidman & Renström 2011)

Other factors

Three parts that affect the energy consumption according to Elias et al. in (Selvfors, 2014) is:

- 1: *“the minimum theoretical amount of energy needed to perform the artefact’s function”*
- 2: *“the intrinsic losses adherent to the technology and materials used”*
- 3: *“the user-related losses that are influenced by how the artefact is used”*.

It is important to understand all the three aspects to be able to reduce the use of energy when using certain products (Selvfors, 2014).

The lifestyle choices of the users will affect the behaviour as well as trends and new technologies (Selvfors, 2014). Behaviours are also affected by people's values and attitudes (Lidman & Renström 2011). Aesthetics, functionality and price is aspects that can also make people to not prioritize energy efficient solutions if they lack in any of these aspect (Selvfors, 2014).

Literature also brings up different methods that are differently successful and effective. Methods that are classified as both successful and effective are goal setting according to Abrahamse et al. in (Selvfors, 2014), commitment according to Abrahamse et al. in (Selvfors, 2014), feedback according to Gardner & Stern in (Selvfors, 2014), information according to Steg in (Selvfors, 2014) and public comments according to Abrahamse et al. in (Selvfors, 2014). Methods that are successful but not as effective are incentives and disincentives with rewards and penalties according to Gardner & Stern in (Selvfors, 2014).

There are three main reasons why understanding pro-environmental behaviour is important according to Selvfors:

1. *“different types of behaviour vary in terms of environmental impact and environmentally significant behaviours are more important to address than others”* Gifford et al. and Stern in (Selvfors, 2014)
2. *“different underlying factors may influence different types of behaviour”* Gifford et al. and Abrahamse and Steg in (Selvfors, 2014)
3. *“strategies for supporting conservation may vary in effectiveness depending on the type of behaviour addressed”* Ölander and Thøgersen in (Selvfors, 2014)

(Selvfors, 2014)

Changed behaviour

To be able to affect the user it is important to *“understand behaviour and its determinants”* and to change a behaviour there are different approaches according to the literature (Strömberg et al. 2015). Renström et al. in (Selvfors, 2014) have a list of five categories in which behaviours can be changed with focus on design and sustainability. The categories are:

1. Changing use of an artefact to reduce consumption
2. Using a secondary artefact to facilitate reduced consumption
3. Modifying or regulating an artefact through the use of a secondary artefact to reduce consumption
4. Maintaining an artefact in good condition to reduce consumption
5. Choose an artefact that requires less resources or less harmful resources

The design of a product is something that can make people change a behaviour and as a designer it is possible to affect the amount of resources the products is using and how the use will be affected by the users Elias, Dekoninck & Culley in (Strömberg et al. 2015). Abrahamse et al.

in (Selvfors, 2014) suggest that strategies for changed behaviour should be focusing on influencing both the specific behaviour but also to influence the preconditions (Selvfors, 2014).

3.2 Green branding

Green branding is a popular area that has developed to become a trend amongst many companies today, and according to Banytė & Gadeikienė (2008) in (Sarkar, 2012) it has become a way to make the brand image stronger. It has also become a way to create more value for the consumers which can be an important and crucial factor on the market. Using green branding as a company, certifications are not what determines if they are green, it is about much more. It is about making the whole company strive towards a coherent sustainability work throughout all their departments (Sarkar, 2012).

Green branding can be categorized into three types of depths where *having greening as core* is the first level, *greening integrated in the core* is the next level and *using green values as guarantees* is the third level (S.Pflanz, 2014) in (Danicu, 2015). It is therefore important for the company to be aware of their view of green branding and green products to be able to place themselves in the level they want to be recognized with. When working with green branding it is important to focus on the customer and the company's honesty, consistency and responsibility, and not only focus on the visual appearance (Danicu, 2015). One way of doing this is to make the company aware of their green key factors. The companies must therefore be aware of how the consumers perceive green products and sustainability features and therefore feedback is an important factor (Danicu, 2015). They must also be aware of what their products stand for and how they are perceived by their customers (Karjalainen et al, 2010).

For a brand to be long lasting it is important for the company to be aware of what it is that makes their products connected to the company (Warell, 2006) and the product families. One way of working towards this is to think about what Warell et al. states in (Warell et al. 2001):

“If the range of products in a product family employs styling features from a common design format, they will all be perceived as referring to each other, and the product family is communicated visually.”

One way of approaching this is to find the company's design features that define their products identity, both through implicit and explicit design features (Karjalainen et al, 2013). This can be done by analysing the products within the company to find similarities between them (Warell et al. 2001) by for example performing a Design Form Analysis, DFA (Karjalainen et al. 2010).

When designing products it is easy to lose focus on the sustainable development when focusing on the aesthetics (Zafarmand et al. 2003). One way of working for this is to work with designing the products so that they do not become waste to fast (Zafarmand et al. 2003), and according to Zafarmand et al (2003) features such as the product being durable, upgradeable, renewable and repairable should be used to avoid this and to be able to be designed for the whole product's life cycle. By reducing components from the products a simplistic expression is captured which

also is a sustainability feature (Zafarmand et al. 2003). The authors also mention that product design for sustainability should be focused on “‘aesthetic durability’; ‘aesthetic upgradeability and modularity’; ‘simplicity and minimalism’; ‘logicality and functionality’; ‘natural forms and materials’; ‘local aesthetic and cultural identity’; and ‘individuality and diversity’” (Zafarmand et al. 2003). Another opportunity with green products is to have the chance to make consumers change their behaviours (Sarkar, 2012).

Creating a value for the consumers is important to succeed with green branding. This can be done through collected data and to bring it into the design process (Person et al, 2008). Important is also to define the target group. Difficulties with creating value for the customers is that a product create different feelings and emotion to people (Stomppff, 2003) and to find those that are common for many users can be a challenge.

Communicating the brand is important and also to communicate the values and to create a good connection to the consumer through a relationship. But the company must also be able to keep their promises. By working with green branding green washing is avoided which is good since it can be misleading for the customers (Danicu, 2015).

3.3 Technology overview

To get deeper knowledge on how the products are constructed and how the components are placed in relation to each other explanatory videos was watched and a disassembly of the three products were made. The disassembly was made on the 7000 series used as reference products during the user tests. This collection will be presented in the last part of this chapter.

3.3.1 How the products function

In order to understand how the products functions, the internet was searched for videos where the products are taken apart and YouTube was a media used. Beyond this, physical products from Electrolux were taken apart using common tools found in most homes. The parts and functions were documented and how the products functions are described below.

The reference products was provided by the company and is the *7000 series breakfast collection* of Electrolux. The products were chosen for their medium price and amount of functions after the benchmarking.

The coffee maker

The basic functions of a coffee maker will be explained step by step by using images from the disassembly of the existing products.

The power to the coffee maker comes in through the cord via the outlet, to the on/off button, fig. 3.2.

When making coffee the right amount of water is filled in the water container, fig. 3.3 & 3.4, and a filter and coffee grains is placed in the filter holder fig. 3.3. The on button is pressed and the brewing process starts. From the on/off button two cords are connected. One is connected to the resistor (metal tube), fig. 3.5, and the other is connected to the thermoregulator fig. 3.5. When the water gets up to temperature, the thermoregulator makes the heating element turn off.

There are also backup thermoregulators which prevent the coffee maker from burning (*Crazy builders, 2016*).

In the bottom part of the water container is a hole that allows the water to be transported to a rubber pipe inlet fig. 3.4 & 3.5. By the inlet of the rubber tube is a ring with a small plastic ball inside. This construction system prevents the water from going back and only allows the water to be transported one way. This forces the water to go out through the other end of the rubber pipe via a metal tube (resistor) fig. 3.5. The metal tube has contact with the heating element (which keeps the coffee warm) which makes the water in the tube boil fig. 3.5. The bubbles created by the heat takes up extra space in the metal tube and forces the water through the rubber pipe number two, pipe outlet fig. 3.4 & 3.5. The water is then transported through the rubber tube to the top of the water container and into the inner lid, fig. 3.3, which enables the water to drip down to the filter fig. 3.3. This cycle is repeated over and over again until there is no water left and the coffee is done (*Crazy builders 2016*).



Figure 3.2: The coffee maker, perspective

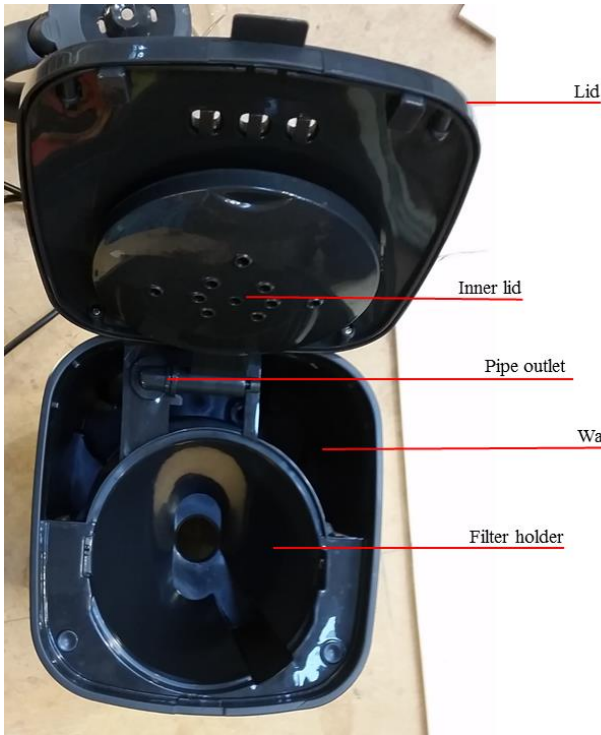

Figure 3.3: The coffee maker, top

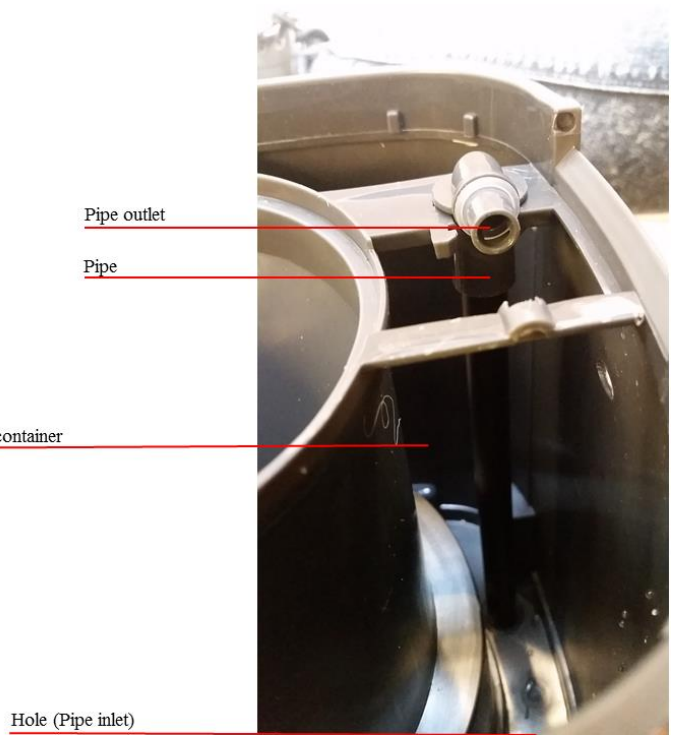

Figure 3.4: The coffee maker, water container

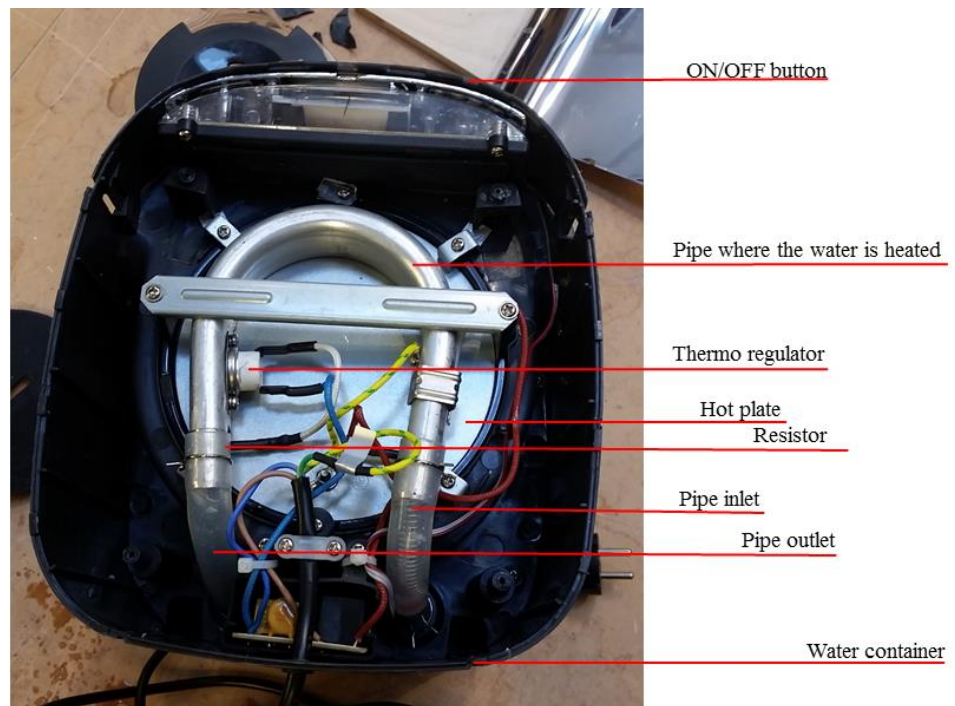

Figure 3.5: The coffee maker, bottom

Kettle

To boil water in the kettle, the wanted amount of water is filled in the water container fig. 3.6. The kettle is placed on the bottom plate, fig. 3.6 and the ON button is pressed fig. 3.6 (And/or other settings if existing).

The heating element in a kettle is a metal coil through which electrical current is flowing when being plugged into an electrical outlet. The heating element is located inside the kettle, fig. 3.6 and gets its energy from the bottom plate, fig. 3.6. The resistance of the heating element turns the energy to heat and makes the water boil when they are in contact. An “instant” water boiler combines more current and less water to make the boiling time shorter. This leads to a more energy efficient water boiler. By using thermostats, usually out of bimetallic, the kettles switches off automatically to prevent danger and the risk of catching fire (Woodford 2011).

To heat one litre of water the energy use is the same no matter what method that is used. What makes the difference is the time. The electric kettle has an advantage since it is a fast method of heating water and switches off when done (*The Guardian* 2016).



Figure 3.6: The kettle, perspective

Toaster

When toasting bread, bread slices are placed in the slots for bread fig. 3.7. Modern toaster have between one and four slots. The settings are made by using the grading wheel, fig. 3.7, or the buttons, fig. 3.7. Using a control, fig. 3.7 the bread is pushed down into the slot and the toaster automatically turns on.

The bottom part of the bread slice stands on a metal arm loaded with a spring. The metal arm can be moved up and down using a control on the outside of the toaster. When the control is moved downwards the bread slice is pushed down into the toaster. At the same time a switch fig. 3.8, is turned on and the heating element starts functioning fig. 3.8. An electromagnet is holding the control stuck in the lower position. After a certain time, that can also be adjusted with the STOP button on the outside of the toaster, fig. 3.7, the electromagnet is turned off, the control is realised and the heating element is turned off and makes the bread slice go up (*Broadroast 2016*).

The energy that the toaster uses comes from electricity. Inside the toaster there are coils of wire and when they become hot they glow because of the electric current. These coils of wire are the heating elements, fig. 3.8 (*Broadroast 2016*). The heating element of the toaster is normally made out of Nichrome ribbon wound on mica strips or Nichrome wire coils (*Toaster articles 2016*). Nichrome is a metal through which electricity cannot pass very easily, called resistance of the metal. Since Nichrome has high resistance the metal will get hot when electrons are trying to pass through it (*How things work 2016*).

There are different ways to switch of the toaster, using a timer (as described above), a thermostat or electronic light-detectors. The thermostat is bimetallic. The metallic parts are connected tightly together and the metals expand different amounts when they are heated up. The heat makes the metallic parts bend to a curve and when bended enough it will switch of the heating element fig. 3.7. The toaster can also use a photoelectric cell (not usually) to create electricity. It uses the light that falls on it to create electricity. The light shines at the bread and the reflected light from the bread decreases when being cooked. A photocell is placed close to it to measure the reflected light and can determine when it is done (*How things work 2016*).



Figure 3.7: The toaster, perspective

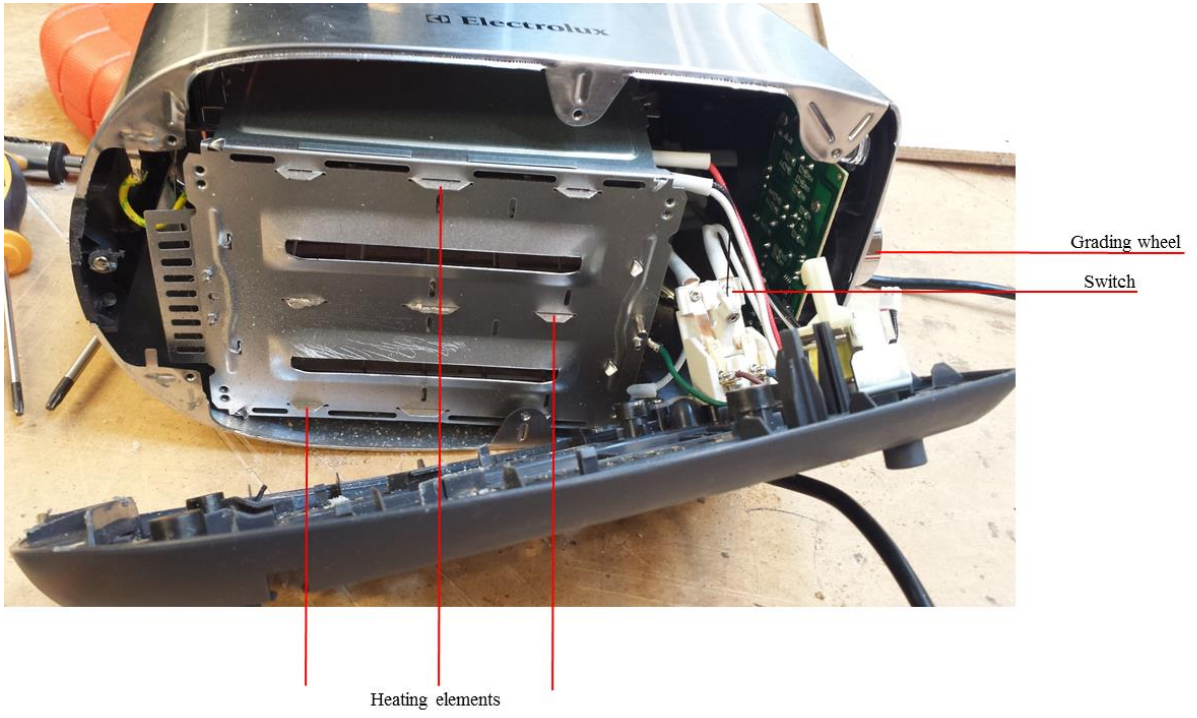

Figure 3.8: The toaster, bottom

3.3.2 The reference products

A breakfast collection consisting of a coffee maker, a kettle and a toaster from the *7000 series* of Electrolux was used during usability tests and as a reference for the project. The three products in the collection are presented below.

Coffee maker

The reference coffee maker that was used during the project is the Electrolux coffee maker *EKF7500* from the *7000 series*, fig. 3.9. The product is mostly made out of plastic and stainless steel, the coffee pot is made out of glass. The capacity of the water container is 1.375 litres and the product dimensions are in millimetres: height 322, width 180, and depth 203.

Features the coffee maker has is that it is possible to brew coffee, set a clock, set a timer and do settings for the aroma. The product also automatically turn off after 40 minutes. The product does have an LCD display as can be seen in fig. 3.10. The Measurement systems can be found on both sides of the water container and on the coffee pot.

(Electrolux 2016k)

(Electrolux 2016l)



Figure 3.9: The reference product, coffee maker



Figure 3.10: The coffee maker, display

Kettle

The reference kettle that was used in the project was the *EEWA7500* kettle from Electrolux *7000 series*, fig. 3.11. The product is mainly made out of stainless steel and has got a capacity of 1.7 litres. Dimensions of the product in millimetres are: height 238, width 160, and depth 210.

The kettle has functions such as setting the water to 50, 60, 70, 80, 90 or 100 degrees Celsius. As the water gets warmer the measurement system behind the handle changes colour between green, blue, purple and red. The kettle can keep the water warm at preferred temperature for 30 minutes. The product does have a digital display as can be seen in fig. 3.12.

(Electrolux 2016m)

(Electrolux 2016n)



Figure 3.11: The reference product, kettle



Figure 3.12: The kettle, display

Toaster

The reference toaster used in the project was the *EAT7100* toaster from the Electrolux *7000 series*, fig. 3.13. The product has a capacity of 2 bread slices and is mostly made out of stainless steel. Product dimensions in millimetres are: height 183, width 175, and depth 283.

This toaster can toast two standard sized bread slices at the same time. The bread can be toasted, defrosted or reheated using the buttons on the side of the toaster. Wanted amount of toasting can be set using a control wheel. The bread can be pushed up extra from the toaster slot using the control on the side, fig. 3.14. A small light above the control wheel indicates which toasting degree has been chosen.

(Electrolux 2016o)

(Electrolux 2016p)



Figure 3.13: The reference product, toaster



Figure 3.14: The toaster, buttons

4. Investigations

In this part the methods, findings and short discussions from the investigations will be presented. The investigations started with a design form analysis followed by benchmarking, focus group, user studies, trend analysis, a categorization and finally a disassembly of the products.

Chapter 4 contains the following subchapters:

4.1 Design form Analysis, DFA

4.2 Benchmarking

4.3 Focus group

4.4 User studies

4.5 Trend analysis

4.6 What a designer can change

4.7 Disassembly

4.1 Design form Analysis, DFA

A design form analysis (DFA) of Electrolux design features was made to capture their design language. Pictures of earlier and current products within the breakfast collection was gathered, printed out and attached on a board. They were divided into their specific categories (coffee makers, kettles, toasters) and analysed by looking at them all together to identify specific aspects for each category to find design features common for all the products. The results of the DFA is summarized below but the whole DFA can be found in Appendix I. The result from the DFA was used in a later phase of the design and branding process of the project.

4.1.1 Explicit design features of Electrolux

General design features for Electrolux breakfast collection is the marked horizontal lines, fig. 4.1, and the combinations of material, fig. 4.2, which often is a combination of two or three, visible, materials. There are many collections with different colours but the most frequently used colours are black and metallic (stainless steel), fig. 4.2. The products buttons are often relatively large. Fig. 4.3, as well as the handles, fig. 4.3. The products are robust and compact and their form language is centralized. On their products the logo is always visible and eye catching, fig. 4.1.



Figure 4.1: Example horizontal lines



Figure 4.2: Example material combinations



Figure 4.3: Example buttons and handle

Design features of the Toasters

Specific design features for the toaster is the use of big radiuses on the edges, fig. 4.4, and its three main components, the body, fig 4.5, the slot for the bread, fig. 4.5, and the area of function buttons fig. 4.4 & 4.5. The toaster have a well-defined top and bottom due to material changes or split lines, fig. 4.4 & 4.5. The toasters have small feet under the bottom, fig. 4.6, and the buttons are often dimensioned after frequency of use, fig. 4.4 & 4.5, they are also defined with a different colour or material. There is no consistency of placement of the logotype.



Figure 4.4: Example, radiuses on the edges and buttons



Figure 4.5: Example, the toasters three main components



Figure 4.6: Example, the feet of the toaster

Design features of the coffee makers

Specific design features for the coffeemaker is the use of a straight silhouette or a slightly time glass shape, fig. 4.7. They have a well-defined top, fig. 4.7, and handles with different material or colour, fig. 4.7. The buttons are often in the front, fig. 4.7 & 4.8, and the lids are well defined with a different material or a colour, fig. 4.7. The coffeemaker have small feet underneath, fig. 4.8, and uses big radiuses on the main body, fig. 4.7. The space for the pot is well defined with colouring, material or form that differs from the rest, fig. 4.7. The pot shows the amount of cups used fig. 4.9.



Figure 4.7: Example, coffee makers



Figure 4.9: Example, the pot



Figure 4.8: Example, the feet of the coffee maker

Design features of the kettles

Specific design features of the kettles are the big and soft handles, well defined with another material or colour, fig. 4.10-4.12. They have four main parts, the body, pipe, handle and the bottom part fig. 4.10-4.12. They all use rounded shapes and the ones in plastic have the water measurements on the sides, fig. 4.11. The ones in metal have the measurements behind the plastic handle, fig. 4.10 & 4.12. The handle is often divided into two parts by a split line or a material change fig. 4.10-4.12. The lid is well defined as well as the bottom with a change in material or colour fig. 4.10-4.12. The pipe is well defined with size and material and the bottom is also defined with a change in material, colour or width fig. 4.10-4.12. The kettles are cylinder-, egg- or cone shaped fig. 4.10-4.12, and the buttons are often placed in the bottom part fig. 4.11 & 4.12. The function button to the lid is on/close to the handle, fig. 4.11.



Figure 4.10, Example kettle 1



Figure 4.11, Example kettle 2

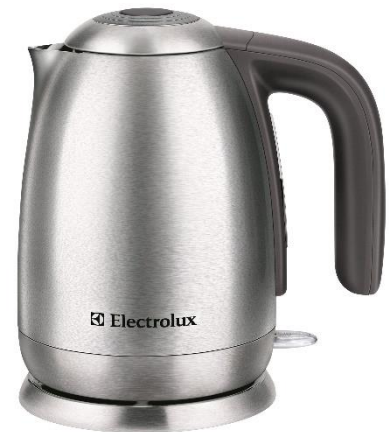

Figure 4.12, Example kettle 3

4.1.2 Findings

In table 4.1 are the design features found for the Electrolux breakfast collection summarized.

Toaster	Coffee maker	Kettle
Big radiuses Material changes Split line Colour Dimensions Logotype	Straight or sandglass shaped silhouette Material changes Colour Placement of buttons Big radiuses	Big handles Material changes Colour Rounded shapes Split lines Dimensions Buttons in the bottom Cylinder-, egg- or cone shaped

Table 4.1, Design features, Electrolux collection

There are clear signatures for the products that are repeated in Electrolux design features. The rounded shapes and big radiuses are examples of this but also the changes in material and colour to define a function are good examples. Both form and the use of the same material throughout a collection is what makes it stand together as a collection. To make it even more coherent the use of same design features on function areas such as buttons could be implemented. When re-designing a collection it should be clear which company it belongs to but also that the different

products in the collection are coherent. These design features does not have to be defined for all the products for them to be a part of the company.

4.2 Benchmarking

To become aware of the existing products on the market along with old products and future products, a benchmark was made by collecting images using Medias such Google, Pinterest and web pages of Electrolux competitors.

An analysis of random products outside of the household area was also made during the benchmarking to become aware of what it is that makes a product be perceived as sustainable or unsustainable. The benchmarking was therefore divided into four parts:

Part 1: Analyse random collected pictures of products and products of Electrolux competitor to see which and why they were perceived as sustainable.

Part 2: Analyse randomly collected products and products of Electrolux competitors to see which and why they were perceived as unsustainable.

Part 3: Analyse the sustainable products within Electrolux such as vacuum cleaners, dishwashers and washing machines.

Part 4: Analyse Electrolux competitors sustainability work by reading about their sustainability approach on their websites.

4.2.1 Part one - Sustainable products

When analysing pictures of products perceived or labelled as sustainable, examples in fig. 4.13, the following features were represented:

- Few materials and simplicity as in few details with visible functionalities for easy understanding of the product.
- Honesty as in visible and clear functionality and components.
- Easy handling as in easy to understand for the user.
- Few details as in clean surfaces with few interruptions.
- Raw materials as in copper, glass wood and vegetation.
- Nudity and hygienic as in unadorned, simple and plain surfaces with dove colours.
- Visible functionalities as in clear split lines and material transitions around function areas.
- Function based as in products only doing what they are supposed to, no extra irrelevant functions are added.
- Minimalistic as in few details and visible functions.
- Reusable and recyclable as in durable, materials that age well, few material combinations and no complex surfaces with different materials integrated.
- Luxury as in clean surfaces, few colours and durable materials.
- Calm expressions as in few details and simple transitions.
- Earth as in warm colours and earth materials such as wood.
- Informative as in distinct, little but prominent information, few details.
- Clear contrasts as in prominent material meetings and surface transitions.
- Clean shape as in few details and matt surfaces.
- Basic geometries as in simple transitions and forms.
- Friendly as in rounded shapes.

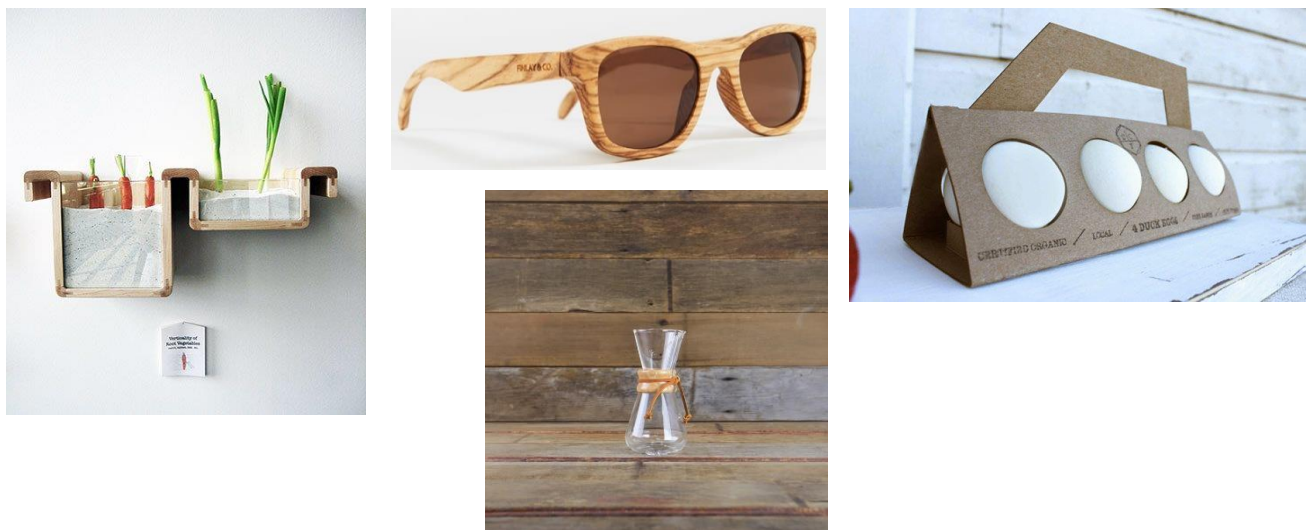

Figure 4.13, Examples of products with sustainable design features

Table 4.2 below shows the whole list of the gathered features found when analysing the sustainable products. The ones marked in bold style was decided to become a focus in this project because they were the most recurrent.

4.2.2 Part two - unsustainable features

When analysing randomly picked pictures perceived as unsustainable, examples in fig. 4.14, the following features were represented:

- Cheap as in consumer product with short life span and easy to replace.
- Colourful as in using unnecessary colouring to highlight the product.
- Plastic associated with being bad for the environment and the quality/life span of the product.
- Fragile as in easy to break and replace.
- Showy as in cheap and colourful.
- Old as in consuming unnecessary amount of energy.
- Unnecessary as in not filling their function, no clear function.
- “Throw and toss” products as in easy to break and replace.
- Massive and heavy as in unnecessary big.
- Extra details as in adding unnecessary functions.
- Lots of different materials.
- Childish as in many colour combinations, material combinations and complex shapes.
- Difficult to recycle as in colourful and unnecessary material combinations.
- Mixed materials as in material combinations.
- More electronics as in unnecessary amount of functions and electronics.



Figure 4.14, Examples of products with unsustainable design features

Table 4.2 below shows the whole list of the gathered features found by analysing the unsustainable products.

4.2.3 Part 3 - Electrolux sustainable products

A summary of how Electrolux work with sustainability from Chapter 1.2, *Company description*, can be found below:

Electrolux sustainable design focuses on the product's environmental impact of the whole lifecycle, from manufacturing to reuse of material (Electrolux 2016f). The sustainability focus Electrolux have today comes from their sustainability strategy where resource efficient solutions are of value and a way to build trust towards customers by their transparency (Electrolux 2016g). For Electrolux it is important to make smart material choices by choosing materials that are recycled, recyclable and resource efficient. The materials should be used in the best possible way to reduce the environmental impact. Waste is constantly being reduced and handled after local regulations (Electrolux 2016h). Electrolux also supports energy labelling of products which is a way of convincing customers that energy efficiency is an important part of choosing products. It is also a way of communicating the efficiency and cost savings to customers (Electrolux 2016i).

When analysing products within Electrolux classified as sustainable it became clear that they work to a great extent with classical features of sustainability. Examples of Electrolux sustainable products can be found in figure 4.15.

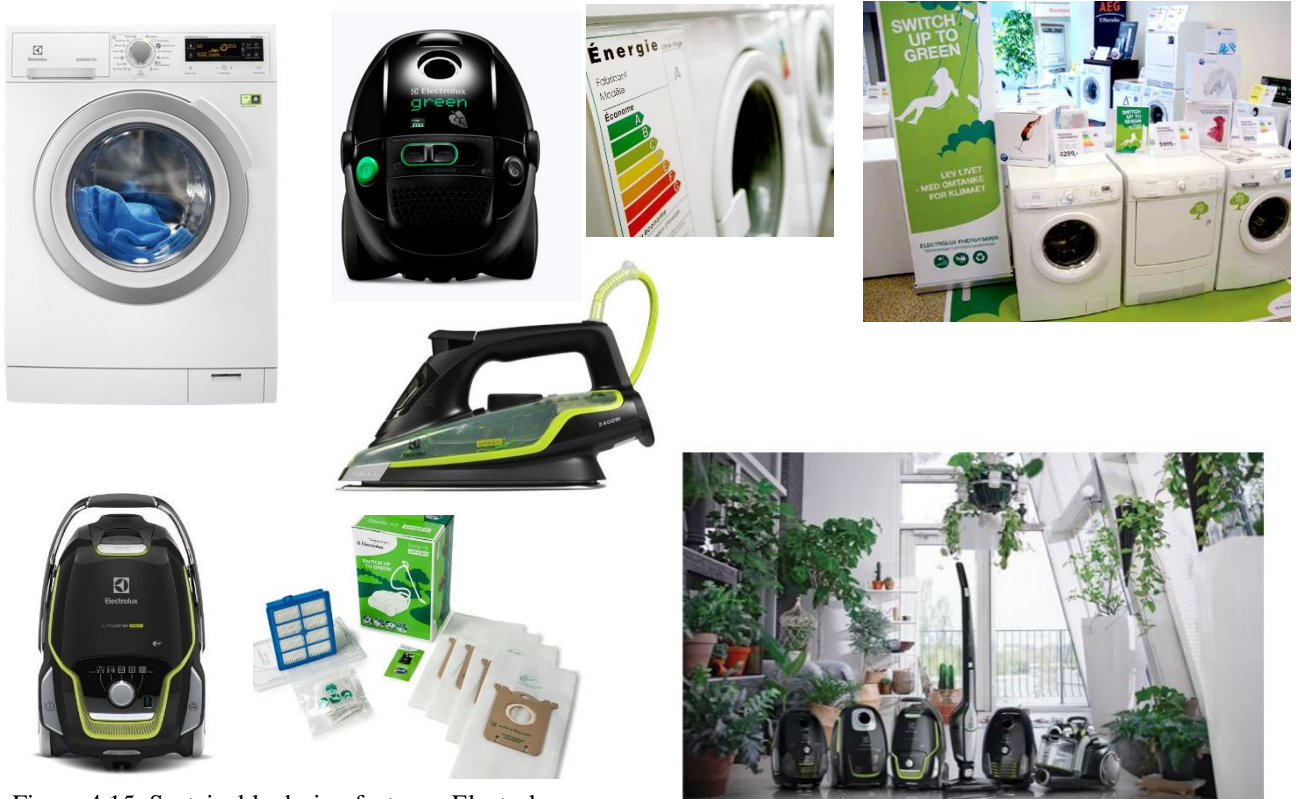

Figure 4.15, Sustainable design features, Electrolux

As can be seen in this picture the following features are represented, mentioned earlier as green washing:

- Green elements on details, printings and components.
- Transparency combined with green elements.
- A lot of labels on the products and packages.
- Plants when exhibition.
- Symbols such as trees and leaves printed on packaging and products.

The design of the products have not focused on the visual elements of sustainability mentioned above in Part 1.

4.2.4 Part 4 - Competitors

In this part of the benchmarking the main competitors of Electrolux was analysed. The assumed main competitors were set to be Philips, Braun, OBH Nordica and WMF due to their product collections and their sustainability work.

Sustainable collection

When analysing the competitors, Philips and WMF had products that were of extra interest. Philips had a breakfast collection that was classified as sustainable, fig. 4.16 and WMF had a miniseries, fig. 4.17. These products were further analysed and specific sustainability features was gathered. These features can be found in table 4.3.

- Optimized as in having less capacity and relevant functions.
- Minimalistic and simplistic as in few material transitions, few functions and few materials.
- Round shapes as in rounded corners.
- The materials, most steel and glass.
- Transparency on products.
- Reduction of materials



Figure 4.16, Sustainable design features, Philips



Figure 4.17, Sustainable design features, WMF

The Competitors sustainability work was also analysed and short summaries of their sustainability work are listed below.

WMF Group

WMF Group have a great focus on sustainability within the company and their aim is to use natural resources in their products and strives to improve their business to care for environmental actions and responsibilities. They also follow standards on environmental protections (WMF Group 2016, *Code of Conduct PDF*). WMF is also promoting the use of small products and have created a collection of a smaller breakfast series, the KITCHENminis® where the coffeemaker is designed for one cup, a kettle with a capacity of 0.8 l and a toaster for one bread (WMF 2016, *WMF KITCHENminis*).

Beside the KITCHENminis® series that focuses on compact living no products are found on WMFs own website that they mark as sustainable. When searching the web for “*WMF sustainable products*” examples of the colour green and leaves does appear in relation to their products, fig. 4.18. This picture is found on one of WMFs own sites (WMF 2016, *WMF coffee machines*).



Figure 4.18, WMF, sustainable products

Philips

Philips is a company that strives for a more sustainable world by their products. They focus a lot on innovation (Philips 2016b), have a great development of green products and green technologies (Philips 2016c) and they follow the Eco Vision program for their sustainability goals (Philips 2016b).

They have an Eco Design process where they try to reduce their impact on the environment created by their products. Their definition of a green products is “*a product that offers an improvement of at least 10% compared with its predecessor or competitor product in at least one of the green focal areas*”. They also focus on circular economy. In 2014 52% of their total sale was green products (Philips 2016c).

An e-mail was sent to Philips customer care support with questions on what made their breakfast collection, classified as “green”, sustainable. It took them several months to answer and when they did it was with the result that they could not say what made their collection sustainable (Therese 2016, *Customer care support Philips oral.*). When Philips presents their sustainable work it is with the use of features such as leaves, the colour green and globes, see fig. 4.19. They do also have their own sustainability program, *a simple switch* which they use to label their products as green (Philips 2016a).



Figure 4.19, Philips sustainable products

OBH Nordica

OBH Nordica tries to follow the definition of UN "development that meets our needs without compromising the ability of future generations to meet their own needs" for their sustainable development (OBH Nordica 2016, *Our Policy for Sustainable Development*).

Sustainable products within OBH Nordica cannot be found, but as can be seen in figure 4.20 they do work with the colour green and leaves on their packages. It is not clear if these are packages of sustainable products or not.



Figure 4.20, OBH Nordica sustainable products

Braun

Sustainability have been a focus of Braun since the 50s. They are inspired by Dieter Ram who was the Head of Design, who said "Good design is concerned with the environment. It can and must contribute to the maintenance and protection of resources." (Braun 2016 *Sustainability*).

Braun work with reducing environmental impact by the users but also within the company and not only with the products but also with packaging and their end of life (Braun 2016, *Sustainability- Sustainability through Our Products*).

No products branded as sustainable could be found on Braun's website or on the web.

4.2.5 Findings

The identified features are summarized below, the features that are bold were of extra importance for the project since they were the most frequently recurrent.

In table 4.2, the list of features symbolizing sustainability and unsustainability are presented.

Sustainable features	Unsustainable features
Simplicity Few details Wood and vegetation Raw material, copper, glass and wood Honesty Nudity Visible functionalities Function based Hygienic Minimalistic Dove colours Reusable Luxury Calm expressions Earth Informative Few materials Clear contrasts Clean shape Recyclable Distinctness Clean surfaces Matt surfaces Basic geometries Friendly Easy to handle	Plastic Showy Old energy crook Unnecessary Colourful Fragile Throw and toss products Not filling their function Cheap Massive Heavy Extra details Lots of material Childish Difficult to recycle Mixed materials More electronics

Table 4.2, Sustainable and unsustainable design features

In table 4.3 the list of sustainability features from Philips and WMF are represented.

SUSTAINABILITY FEATURES
Minimalistic Optimized Round shapes Materials (Steel and Glass) Transparency Few functions Simplistic Reduction of materials

Table 4.3, Sustainability features, Philips and WMF

In table 4.4 features of greenwashing found in the company's products are listed.

GREENWASHING FEATURES
The colour green Prints of leaves, trees and globes Labels Labels developed of the company Plants Developing their own sustainability awards

Table 4.4, Features of greenwashing

When looking at the company's own web pages it is perceived as if they all have a strong sustainability focus. The companies are working towards existing programs and definitions of sustainability.

A thorough benchmarking was made but it could have been developed further by contacting competitors to get more specific answers about the products toaster, coffee maker and kettle.

4.3 Focus group

To strengthen the findings from the benchmarking, a focus group was held around sustainable and unsustainable expressions of products.

The focus group was held with four design students to discuss the topics sustainability and unsustainability. The ambition was to get deeper insights of what it is in products that is perceived as sustainable or unsustainable. The focus group duration was 60 minutes where an introduction of the project was presented followed by a presentation of the participants. The discussion was divided into three parts:

Part 1: Pictures of abstract items/environments were placed in front of the participants. They were supposed to pick one picture they perceived as sustainable and one that was perceived as unsustainable. After that followed a discussion of the participant's thoughts and motivations to their choices.

Part 2: Pictures of randomly picked products were placed in front of the participants. They were supposed to pick one picture they perceived as sustainable and one that was perceived as unsustainable. After that followed a discussion of the participant's thoughts and motivations to their choices.

Part 3: Focused on specific themes that the participants mentioned during the discussion to get deeper insight.

4.3.1 Part one

All the participants picked a picture from the abstract picture category that they perceived as sustainable. These were not pictures with specific focus on sustainable or unsustainable expressions. Examples of products are pictures of flowers, packages of eggs or buildings.

Abstract pictures perceived as sustainable

The pictures in figure 4.21 was collected.



Figure 4.21, Pictures perceived as sustainable

To figure 4.22 the participants thought that the old construction was built on few materials associated with infrastructure and that it would last for a long time as a result of a solid material. They also discussed the work that was put behind the construction and that that type of work gives a sustainable feeling. Some of the participants did not agree and explained it with that their associations with that type of work and constructions is that it is remade many times because of necessary renovations.

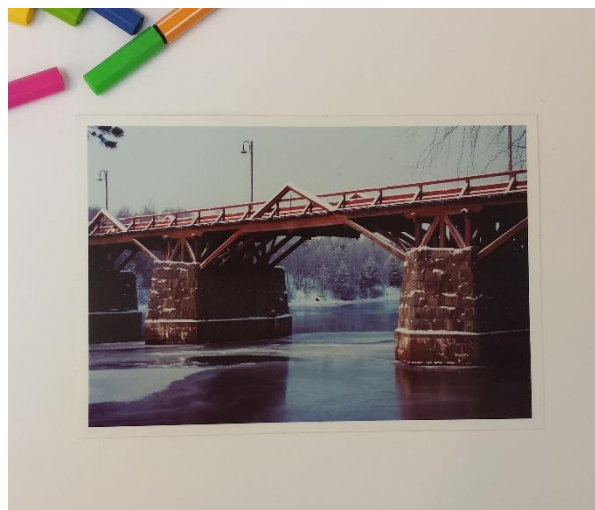

Figure 4.22, Picture of an old construction

Figure 4.23 reminded the participants about sustainable manufacturing and sustainable transportations. All of the participants agreed.



Figure 4.23, Picture of a waterfall

Figure 4.24 was perceived as sustainable because of the association to products that are mostly made out of plastic. This picture reminded them about reuse and that products that is not needed anymore could be sent to others that needed them more. This promotes a sustainable way of reusing products. It is associated to a more modern approach. *“You cannot take back what is done but you can pass it on and give it a second life”*.

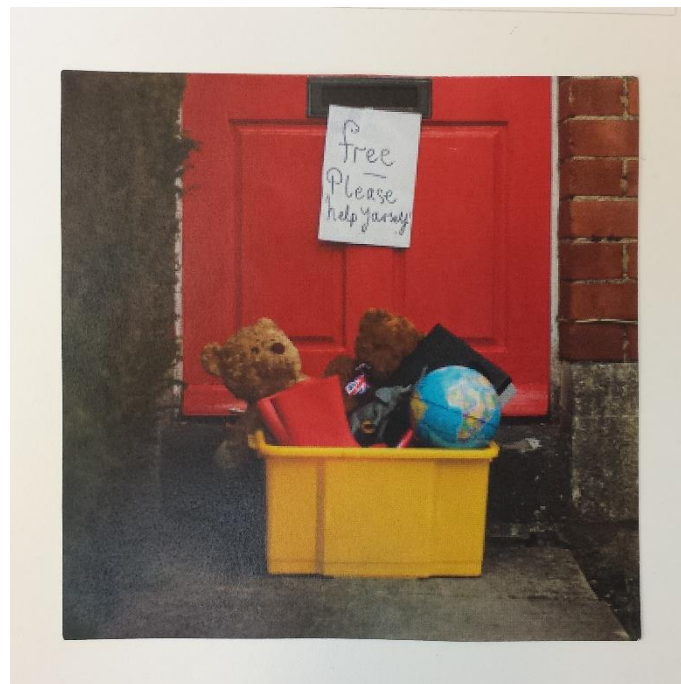

Figure 4.24, Picture of a teddy bear

In figure 4.25 the participants liked the simplicity, with materials that can easily be separated and recycled. Few materials used and clear and distinct split lines contributes to a more sustainable approach.

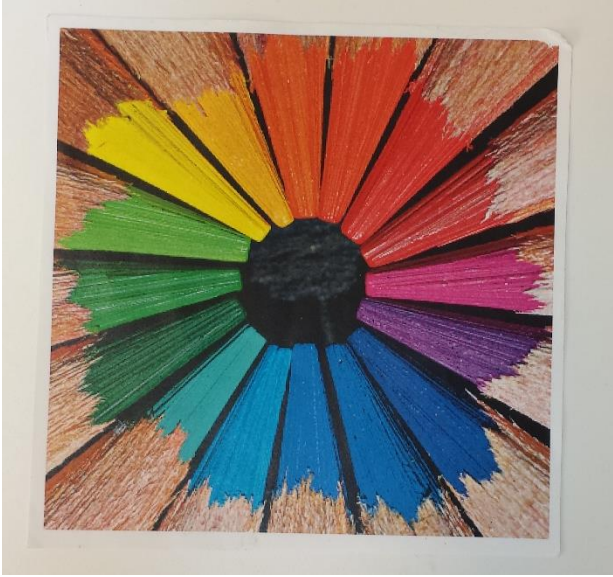

Figure 4.25, Picture of different colors

Abstract pictures perceived as unsustainable

The pictures in fig. 4.26 were collected.



Figure 4.26, Pictures perceived as unsustainable

In the discussion about the abstract unsustainable products the first picture discussed was the picture in fig. 4.27. This was perceived as unsustainable, not because of that plants are unsustainable, but green leaves are symbolized as green washing according to the participants. Green leaves are seen everywhere and should be avoided if wanting to be perceived as green. It is also the colour green that contributes to this feeling. Sustainability is much more than the colour green. Today it is more worth to be able to show that this is actually the case by labels and signs given by different foundations but when a company has developed their own sustainability symbols it can be interpreted as a warning sign that they do not reach the high existing regulations.



Figure 4.27, Picture of green leaves

Figure 4.28 was associated with the global industry and mass consumption with unsustainable products. This picture is also associated with other transportation systems.



Figure 4.28, Picture of a colorful construction

The item in figure 4.29 was associated with a products that last for a couple of years and then get out of date. That is, according to the participants, not associated with sustainability. It is just unnecessary electronic components which will not be recycled which results in a bad consumption habit. These types of products, where there is a fast development speed, especially when it comes to technology, may result in people wanting to have the latest products even though it do not affect the performance of the product. In this case it is just innovation for the sake of innovation.



Figure 4.29, Picture of digital camera

The last picture, fig. 4.30, was associated with the fact that unsustainability is not only about materials, economics and social sustainability. It is about the whole lifecycle and these are all aspect to keep in mind and not just one of them.



Figure 4.30, Picture of an old man on a bicycle

4.3.2 Part two

In part two, pictures of products were laid in front of the participants and they got to choose one sustainable product and one unsustainable product. The pictures presented to the group had been selected with focus on products that were labelled as sustainable or products that could be perceived as greenwashing.

Sustainable products

The pictures in fig 4.31 were collected.



Figure 4.31, Products perceived as sustainable

The discussion were first about the sustainable products and here the picture in figure 4.32 was perceived as sustainable due to its clear and distinct meetings between different materials which shows that they are able to be separated. The product have a timeless design with easy and simple shapes and nice surfaces. The clear split lines is associated with a reusable material and the glass makes the product more elegant and make it more desirable to have on display. It is also assumed that the glass will make the user be more careful with the product.

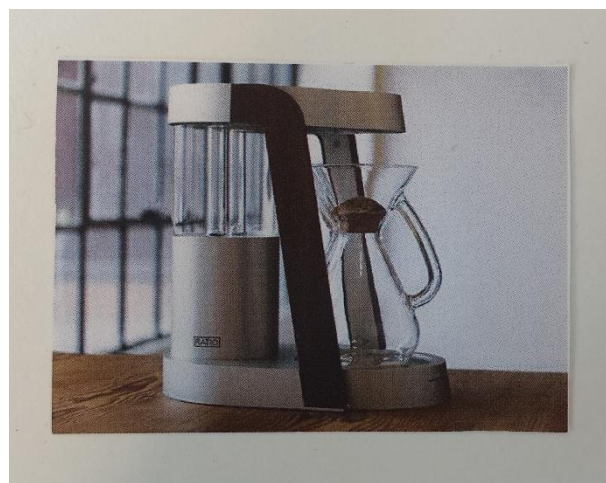

Figure 4.32, Picture of coffee maker

Picture in figure 4.33 was sustainable because of its cleanness and simplicity. It is given an extra value when the carton is used as a holder for the eggs. The material used is only the ones necessary which makes the product minimalistic.

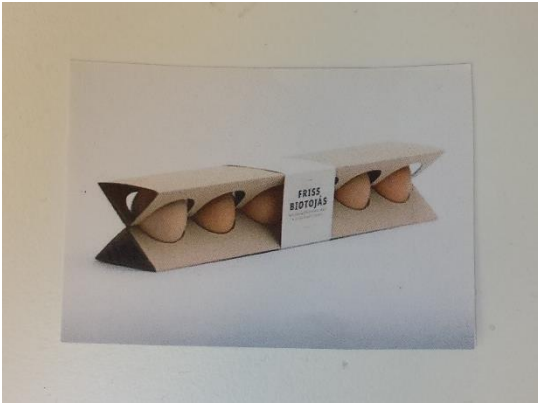

Figure 4.33, Picture of egg carton

The picture in figure 4.34 was also picked because of its simplicity and that it is separable. There are good contrasts between the materials which make it look sustainable. The materials seems to be durable.



Figure 4.34, Picture of lamp and bottle

In the picture in figure 4.35 the focus was on the value word around the products. There are no extra colouring that are unnecessary, it does what it is supposed to do but not more.



Figure 4.35, Picture of cartons

Unsustainable products

The pictures in figure 4.36 were collected.

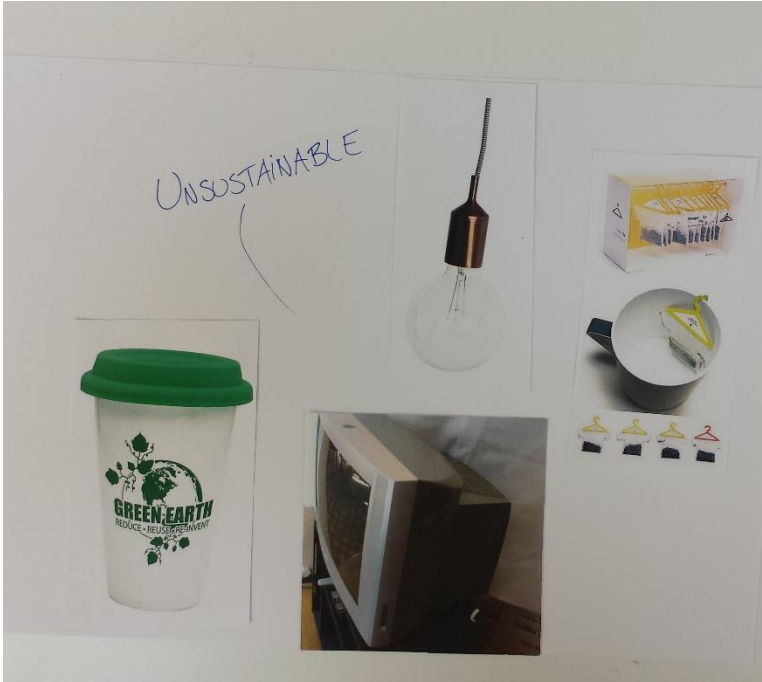

Figure 4.36, Products perceived as unsustainable

In the discussion of the unsustainable products the picture in figure 4.37 was perceived as unsustainable due to the old plastic parts and the amount of electronics in it. There are a lot of toxic materials and takes a lot of energy when running.

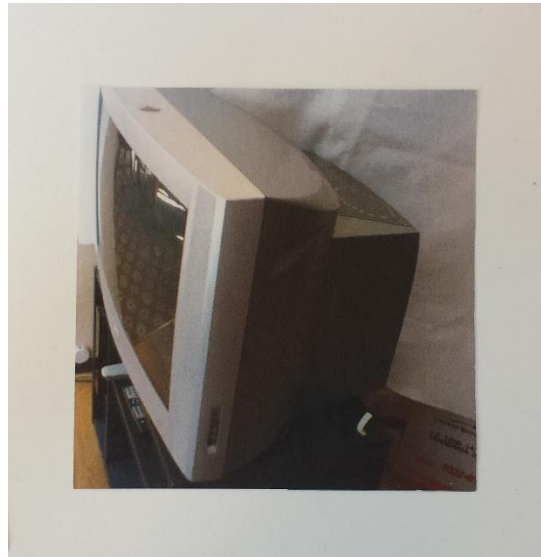

Figure 4.37, Picture of old television set

In the picture in figure 4.38 the amount of energy that it gives out from heat is high and there are many options that are better on the market today.



Figure 4.38, Picture of lamp base

The picture in figure 4.39 screams out greenwashing according to the participants and they do not believe the message of a dispositional cup. It is coloured in an unnatural way and they are not sure about the material which also makes them confused.



Figure 4.39, Picture of green cup

The picture number in figure 4.40 has no good design according to the participants, they do not get the association of a skirt with a teacup. It is a bad packaging that mostly transports air and it becomes an unsustainable event when the materials are good. It is more a buy and waste product.



Figure 4.40, Picture of packaging

4.3.3 Part three

After the discussions the participants were asked about some of the reflections they had mentioned during part one and two.

On the question about why a natural material is perceived as sustainable they answered that it was because of its purity. There are no toxics in colouring or lacquer, you know what it is. The material shows the transparency and honesty and there is a lot of information about the recycling of the materials.

The participants also mentioned transparency and that it was perceived as sustainable and when asking about that they answered that glass is easy to recycle, and the manufacturing is good. The material last long and do not contribute to unnecessary emissions. It is an honest material.

The participants did also mention minimalistic design. To this they answered that it is the material use that is in focus. That you can see how the products functions, you can see if it is dirty and you can see if it is clean. The shapes are often simple which contributes to a simple manufacturing.

4.3.4 Findings

Design features for products to be perceived as sustainable are summarized below:

- Clear and distinct meetings between different materials
- The product should have a timeless design with easy and simple shapes and nice surfaces
- The product should have clear split lines
- The product should use reusable materials
- The product should express cleanness and simplicity
- The products should be given an extra value
- The product should use a minimalistic design
- The products should have good contrasts between the materials for a sustainable expression
- The products should use durable materials
- There should not be extra colouring that are unnecessary
- The product should do what it is supposed to do, not more
- Avoid plastic parts
- Decrease the amount of electronics
- Avoid features of greenwashing
- The product should be easy to recycle
- The materials should last long and not contribute to unnecessary emissions
- The user should be able to see how the product functions
- The product should promote simple manufacturing

4.3.5 Discussion

All participants in the focus group were design students. This can have contributed to more profound discussions about sustainability because it is a big part of their education and they did all have some pre knowledge in the field of sustainability. It could also be that their way of perceiving features typical for greenwashing would mediate something completely different to someone not aware of the term green washing.

4.4 User studies

Different types of user studies such as a survey, customer journey mapping, interviews and usability tests was made during the process. The results from each can be found below.

4.4.1 Survey

A survey was conducted to gather information about how a general breakfast collections is used and thought upon by the users. The survey had 50 questions and was created in Google drive and sent out as a link on both Facebook and by email. The survey included a combination of questions where the participants got to answer questions with own words, choose between different options or using grading on a scale. The survey was divided into four parts where the first part aimed to answer general questions such as gender, age and where and how the participants lived. The second part focused on toasters and questions such as how long the participants expected a toaster to last, how often it is used and where it is stored were asked. The third part focused on the kettle and the fourth part focused on the coffeemaker with similar questions.

The survey got 108 answers in total with a variation over different questions. The survey with summarized answers can be found in Appendix II.

When analyzing the result it was seen that 64,5% out of 107 that answered was between 21-30 years old and 16,8% was between 51-60 years. 79% of 105 that answered lives in a town and 86% out of 107 answers do not know how much energy their kitchen appliances are using.

Findings

Summary of statistics, toaster

- 80,2% of the ones that answered had a toaster
- 48,9% of 88 expects them to last more than 10 years
- Out of 87 answers 75,9% normally toast two slices of bread each time
- 57% out of 86 answers do not remove the plug from the outlet after use
- 80,9 % out of 89 answers do not consider to repair their broken toaster if warranty is not remaining

Summary of statistics, kettle

- 82,2% of 107 answers owns a kettle
- 34,5 % expects it to function for more than 10 years
- 41% out of 87 answers use the kettle a couple of times every day
- 46,6 % of the 88 that answered uses the indicators in decilitre to estimate the amount of water but 26,1% do not use the measurement system at all
- 71,6 % of 88 answers usually boil too much water
- 60,2 % out of 90 do not remove the plug from the outlet after use
- 65,9% out of 90 always have the kettle on display
- 58,6% of 87 answers always wait until the kettle is done before using the water
- 75,9 % out of 87 answers would not repair the broken kettle if warranty is not remaining

Summary of statistics, coffee maker

- 71,2 % of 104 answers owns a coffee maker
- 79,7 % of 74 answers use the indicators for estimating the amount of water in number of cups
- 64% out of 77 usually make the exact amount of coffee that they need

- 50% of 75 answers save the extra coffee that is brewed
- 58,1% of 74 do not remove the plug from the outlet after use
- 65,3% of 75 answers always have the coffeemaker on display
- 66,2 % out of 76 always wait for the coffee to be done before taking the pot
- 56 % of 75 answers would consider to repair a broken coffee maker if warranty is not remaining

Findings from the survey functioned as indications of potentially critical areas within the use of the products in the breakfast collection. It was also found that both coffee maker and kettle are used more frequently, and together with the toaster all three products are represented in most Swedish homes. One potentially critical aspect is that people do expect the products to last for a long time but if they break most people are not interested in repairing them. Another critical area that was identified was that most people do not unplug their products after use. Products still consumes a small amount of energy when connected to the outlet and products consisting of a display does consume more. The use and lack of use of the measurement system connected with the fact that most people boil too much water is also critical.

Comments from participants

The participants in the survey were given the possibility to add comments in the end of the survey. Some of their comments are summarized in table 4.5.

	<p><i>“I like glass better than plastic, doesn’t feel good to boil water in a plastic container”</i></p> <p><i>“The design is also important to me when buying a new coffee maker”</i></p> <p><i>“We use a “percolator”, therefore no answer about filters”</i></p> <p><i>“I have a “Presso-bryggare” thus I’m only using the kettle”</i></p>
	<p><i>“After a while it looks rusty in the bottom which is not very nice”</i></p> <p><i>“I like kettles in glass where you actually can see the water, feels more clean”</i></p> <p><i>“I rarely measure the amount of water that I’m heating, I just fill up what I think I need, but usually end up pouring a lot of excess water in the sink”</i></p> <p><i>“There should be an included kit to clean it from lime scale”</i></p> <p><i>“A friend of mine bought a new kettle rather than cleaning the old one”</i></p> <p><i>“The minimum of water that you must boil (indicated on my kettle is 0.5L) is already more than what I need for one cup of tea”</i></p>
	<p><i>“If you just want one toast, there should be a function to not warm the whole toaster up”</i></p> <p><i>“When I buy a new toaster it’s also important to me that it has got a stylish design”</i></p> <p><i>“I would not repair a broken toaster”</i></p>

Table 4.5, Comments from participants, survey

Discussion

The answers can be affected by the age range of people that answered due to the Medias that the survey was sent out via. The answers cannot be seen as completely accurate for the project since people outside of the target group was allowed to answer the survey.

4.4.2 Interviews

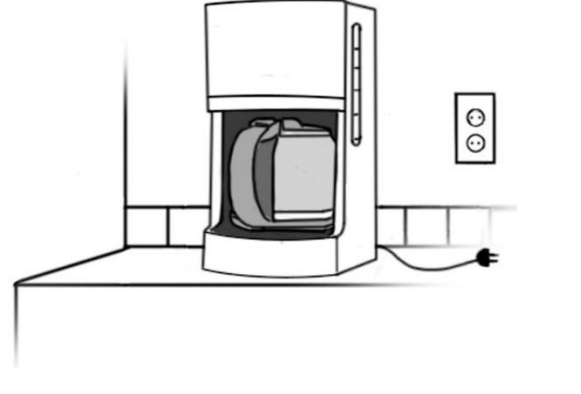
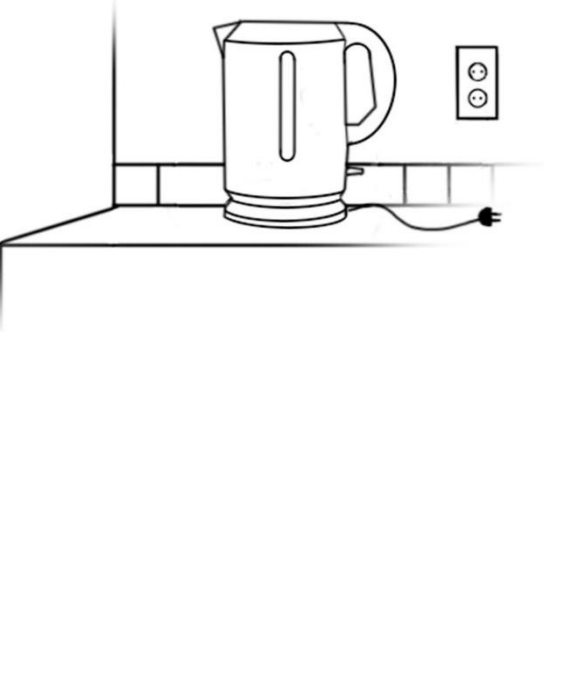
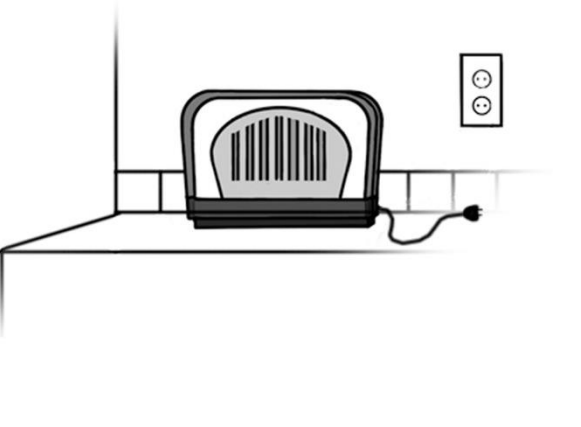
During the pre-study, 15 semi structured interviews were conducted on a mix of people with different backgrounds, ages and genders within the target group of 1-2 person households. The interviews were held face to face and questions connected to the products such as morning routines, where the products are stored and general thoughts about how the products are perceived were inquired. Questions about behavioral change and what type of feedback that would be preferred was also used along with sustainability focused questions such as repair and recycling. Summarized questions and answers from the interviews can be found under Appendix III.

The interviews were held to confirm answers from the survey and to get a deeper understanding of the use of the products (coffee maker, kettle and toaster).

Findings

The 15 interviews confirmed the findings from the survey. According to the interviews the use of the products varies and the coffeemaker is the product that is used the most often, 1-7 days a week while the kettle is used 1-5 days a week. The product used less is the toaster, 1-3 times a month. The frequency of use correlates to where the products are stored. The products used more often is kept on display, for the coffee maker it was nine out of nine times and for the kettle nine out of ten times, while the toaster is stored in a cabinet or a drawer in nine out of fifteen times.

The measurement system is often used but in different ways in relation to the products. On the coffeemaker it is used more accurate and precise while on the kettle the max and min limits are used instead of the actual cups/dl limits.

The cleaning routines is also similar between the interviewees, the coffeemaker and the kettle are cleaned by only washing it under pouring water. No decalcification is done in most cases, four out of eleven for coffeemaker and one out of eleven times for the kettle. The toaster is in almost all cases (nine out of fourteen times) turned around and shaken to get the crumbs out.

When using the kettle it is often water left when done and that is poured out in eleven out of fourteen times, and in rare cases, three out of fourteen times, it is reused the next time. The products overall expressions are often perceived as big and clumsy.

When asked about ways of preferred feedback, the interviewees would prefer it differently. Some wanted the result of how much energy the products used as a summary over month. Others wanted the feedback directly connected to the products, some on a separate unit, and some would prefer an app where diagrams of the used energy is visible. There are also different opinions of whether having the feedback as vibration, sound or light or if it should be immediate or passive feedback.

Comments from participants

The participants in the interview were asked to give comment about their own products at home. Some of their comments are summarized in table 4.6-4.8.

	<p><i>“I would like to have a classical coffee maker and an espresso in one, I like multi-functionalities! And then I wouldn’t need to have as many products on display”</i></p> <p><i>“My coffee make is annoying because it feels dirty and I don’t know how to change the filter so it is just disgusting”</i></p> <p><i>“I usually use it to make tea”</i></p> <p><i>“It should be easy to see the measurement system”</i></p> <p><i>“The measurement system should be easy to understand”</i></p> <p><i>“It should not feel unnecessary to only brew one cup”</i></p> <p><i>“It is important that it fits on the countertop even if it is under a cupboard, the lid of the coffee maker must be possible to open completely, you should not have to stand and hold the lid of the coffee maker as you pour the water”</i></p> <p><i>“The measurement system is hard to see, but I have learned how to use it by now...”</i></p>
---	--

Table 4.6, Comments from participants, interviews, coffee maker

	<p><i>“My kettle is pretty ugly, but it was my partners from the beginning”</i></p> <p><i>“It has a strange colour in the bottom”</i></p> <p><i>“The cord is so short! Would appreciate something cordless...”</i></p> <p><i>“I always end up with water left that is poured out”</i></p> <p><i>“If I were to have it on display it must be flexible and really good looking”</i></p> <p><i>“Looks too plastic”</i></p> <p><i>“I think they are disgusting, because there is always something white in the bottom that ends up in your cup, I prefer to boil my water in a pot on the stove”</i></p> <p><i>“It does what it is supposed to, I don’t think so much about it”</i></p> <p><i>“I have thought about the minimum-level and that I think it is too much”</i></p> <p><i>“If I buy a new one I do not want it to be plastic”</i></p>
--	--

Table 4.7, Comments from participants, interviews, kettle

	<p><i>“My toaster looks like a space ship”</i></p> <p><i>“It has extra features which I have never used...”</i></p> <p><i>“I don’t use it that much so it is just standing there”</i></p> <p><i>“It takes up a lot of space and it’s just a toaster for two slices of bread”</i></p> <p><i>“What does the measurement system on the toaster stand for, minutes or heating degree?”</i></p> <p><i>“The measurement system works differently for all kinds of bread”</i></p> <p><i>“I just want a piece of toasted bread so I don’t need any extra functions”</i></p> <p><i>“It is annoying with all the bread crumbs”</i></p> <p><i>“It would have been nice if I could clean it in an easier way than turning it upside down”</i></p> <p><i>“Toasters are ugly things”</i></p> <p><i>“I never remember what grading to use so I always end up with a bread slice that is toasted too much or not at all”</i></p> <p><i>“Sometimes it is hard to get the bread slice up from the slot”</i></p> <p><i>“I want a clear cancel button”</i></p> <p><i>“You never know when the bread is done”</i></p>
---	--

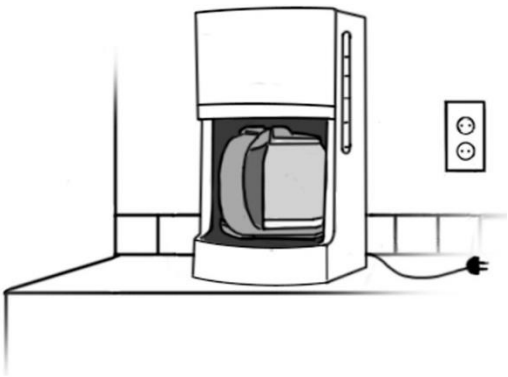
Table 4.8, Comments from participants, interviews, toaster

Discussion

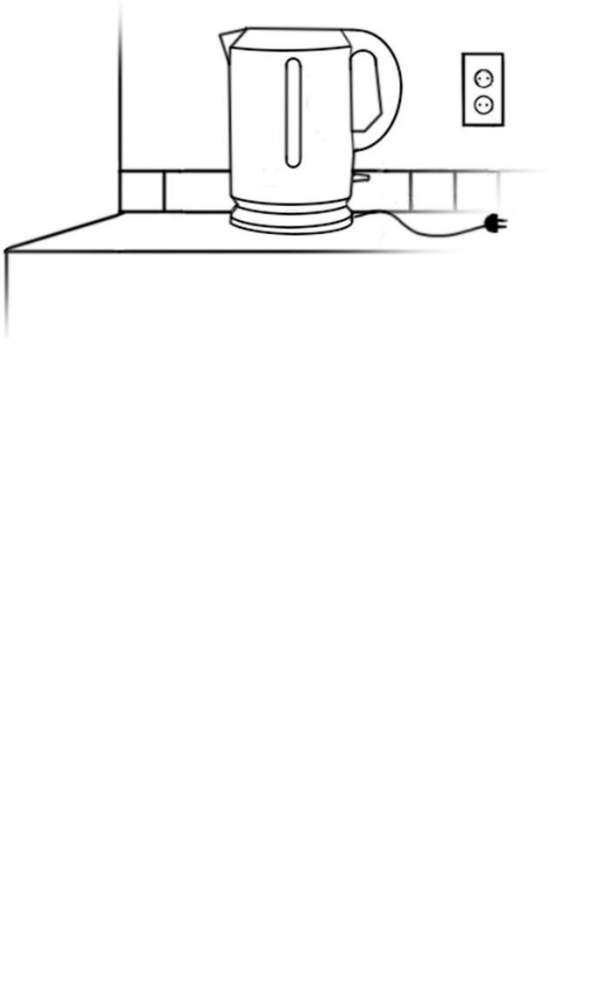
The answers from the interviews can be strengthened by the fact that the participants were all in the target group. Both age, background, profession and gender were mixed between the participants. The result might on the other hand be influenced by the amount of people interviewed and the fact that the participants were not enthusiasts of the products. This could have affected the results. The answers of everyday users could then have been compared with enthusiasts answered to see if their expectations and interpretations of the products were the same.

4.4.3 Customer journey mapping

To visualize how the different products (coffee maker, kettle and toaster) are used and to locate possible critical areas during use, a customer journey mapping for each product were made. The scenarios are based on the answers from the survey and by personal assumptions. The areas assumed to be the most critical were highlighted in red. These areas are parts where more focus

should be laid and more information gathered. After the interviews were done the critical areas were analysed again to see if the assumed paths were corresponding to each other.

Coffee maker

Figure 4.41 shows the coffeemakers consumer journey during use and the critical areas found are listed below:

- When the products are not in use, is there a difference in the energy consumption if the product is connected in the outlet compared to if not being connected?
- Is there a difference in how much water is wasted when using eye measurement compared to the set scaling given on the product?
- Is there a difference when using a reusable coffee filter or a disposable filter?
- Is there a difference in energy consumption when using a timer compared to turning the coffee maker on manually?
- What is best in a sustainability point of view, save coffee brewed at home or buy coffee?

Kettle

In figure 4.42 the consumer journey of use of the kettle illustrated and the critical areas found is listed below:

- When the products are not in use, is there a difference in the energy consumption if the product is connected in the outlet compared to if not being connected?
- Is there a difference in how much water is wasted when using eye measurement compared to the set scaling given on the product?
- Is there a difference in energy consumption if letting the kettle finish boiling or cancelling it in beforehand?
- What is done with or if there is extra water left, is it poured out or is it saved?

Toaster

In figure 4.43 the consumer journey of the toaster can be seen and the critical areas are listed below:

- When the products are not in use, is there a difference in the energy consumption if the product is connected in the outlet compared to if not being connected?
- Is there a difference in using frozen or fresh bread?
- How much does it matter if the bread is burnt or toasted to little compared to a perfect toasted bread?

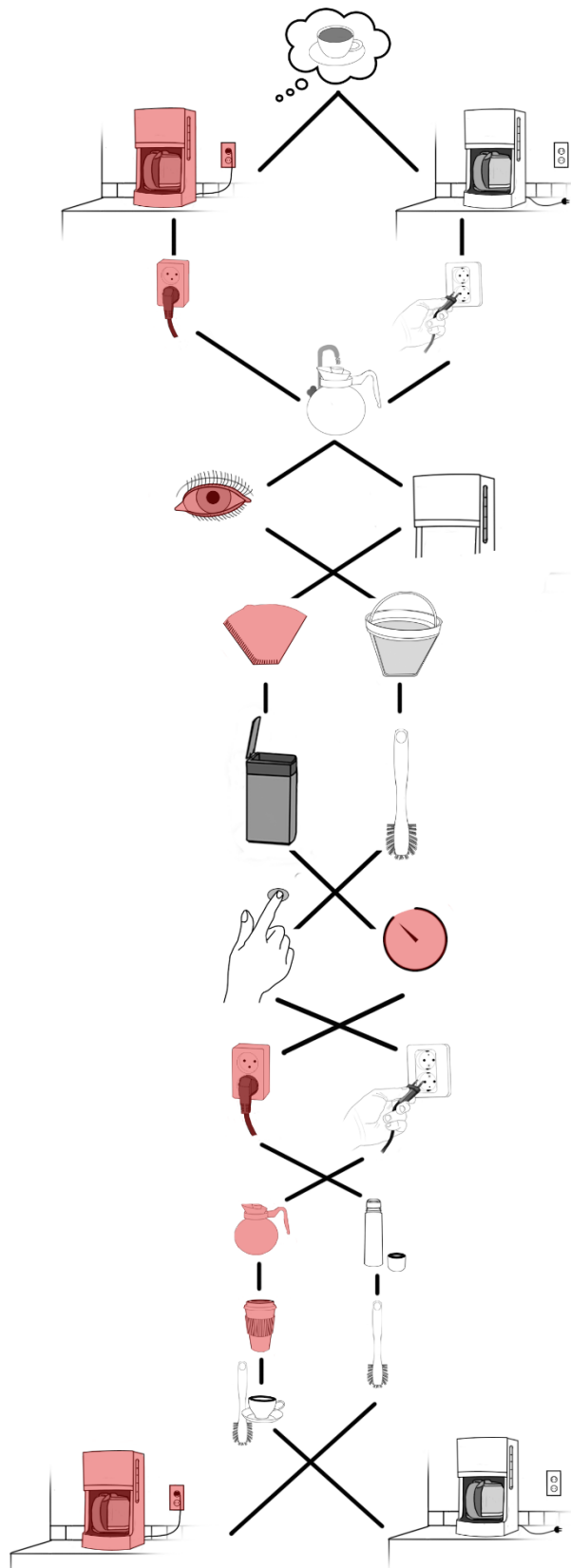

Figure 4.41, Customer journey, coffee maker

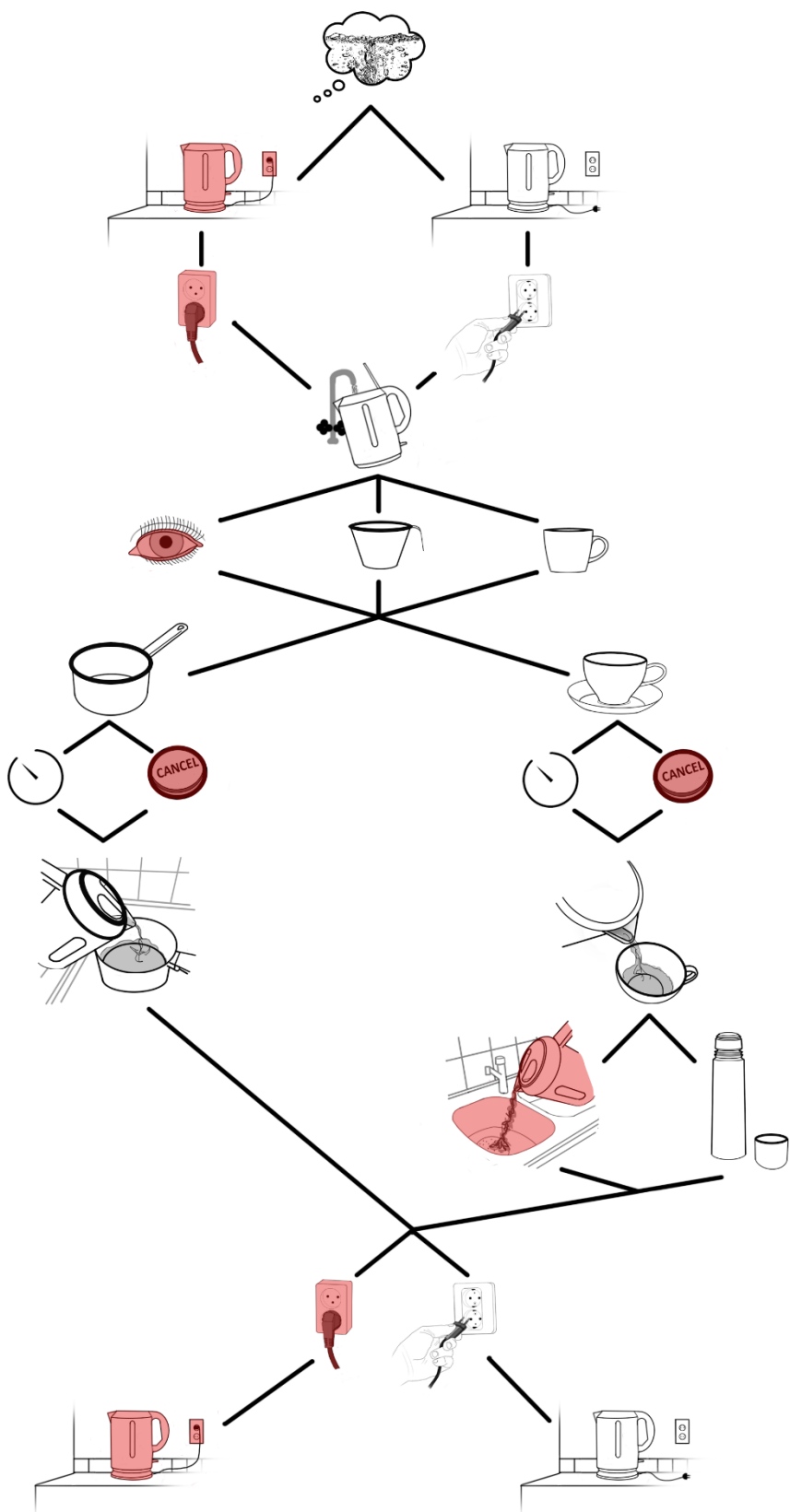

Figure 4.42, Customer journey, kettle

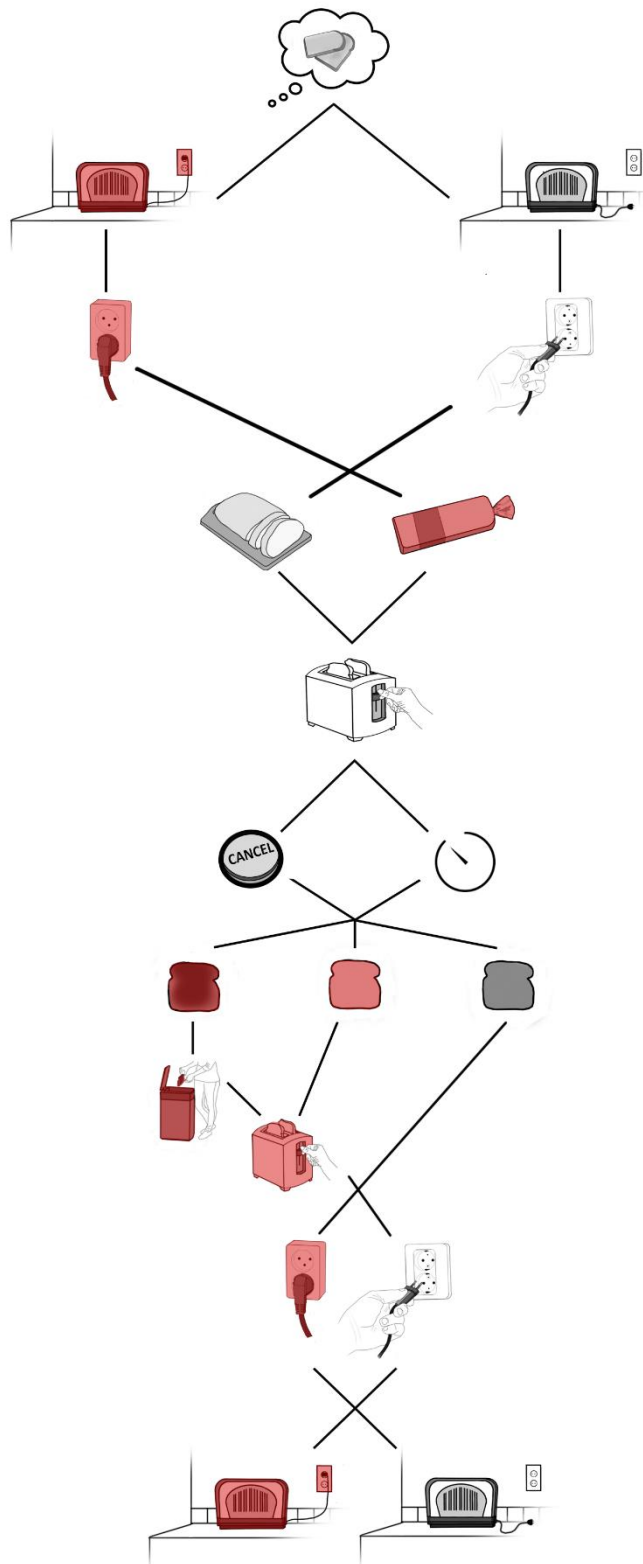

Figure 4.43, Customer journey, coffee maker

Analysis

Information gathered from the highlighted areas was analysed and found that products with no display use 0.5W when not running and products with a display use less than 1W (Ryan & Hakan 2016, oral). The difference in using frozen bread and fresh bread is depending on if using the same settings for both. If doing so, the energy consumption is the same but the result will be different for the breads and the user might have to re-toast the frozen bread again to get the same result which leads to more energy being used. There is also a possibility to use the defrost function, then the energy will be different but the result will be the same on frozen and fresh bread with the same settings.

If the kettle is turned off before it is finished it does not affect the product in a bad way and if the kettle have a keep warm function the energy used depends on how long it will be in function. This can be calculated by the function below:

$$Q \text{ [Joule]} = m[\text{kg}] \times c [4184 \text{ for water @ } 20^\circ\text{C}] \times \text{delta-T [Celcius]}$$

$$P \text{ [Watt]} = Q / 3600 [\text{sec. or 1hr}]$$

Example: How many Watts to boil 10 litres of water, start temperature of water is 14 °C.

$$m = 10 \text{ kg} \quad \text{delta-T} = 100 - 14 = 86$$

$$Q = 10 \times 4184 \times 86 = 3600000 \text{ Joule}$$

$$P = 3600000 / 3600 = 1000 \text{ Watt hr} = 1 \text{ kWh}$$

1Watt=1Joule/Second. Therefore 1kW would take 1 hour

(Ryan & Hakan 2016, oral)

Discussion

A customer journey mapping is a good way of visually show a sequence of use. Since the customer journey mapping was only based on answers from a survey, interviews and assumptions the accuracy can be uncertain. The accuracy would have to be confirmed in user tests where the actual use situation is analysed.

4.4.4 Personas

Creating personas makes it easier to communicate user's needs and behaviours. They are used as a way of exemplifying user patterns and to describe the target users. The personas communicates the user needs, preferences and their demographic and biographical information. Artefact boards is used as a complement to the persona to illustrate the character, artefact and expression of a person. The personas will later in the design process be used as an evaluation tool to see if the new design fits the target users (Karlsson 2007).

Based on user research such as surveys and interviews, three personas were made to easily communicate behaviours and other attributes of the target users.

Lars and Lena

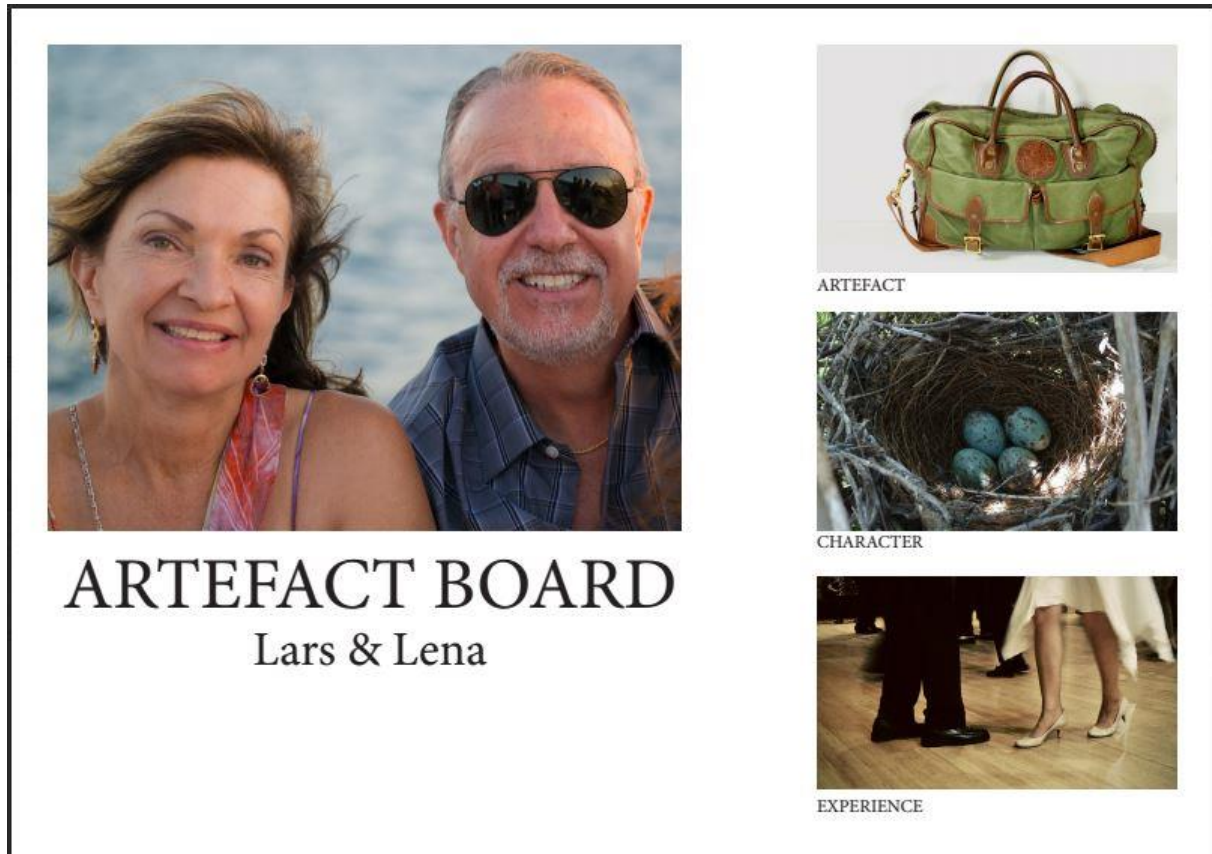

Figure 4.44, Persona artefact board, Lars and Lena

Lars lives in a big house outside of Gothenburg together with his wife **Lena** and their dog Stella. Since their kids moved out a couple of years ago the house has started to feel empty and too big for the two of them. Both Lars and Lena are still working full time and experiences that they have a lot of money left each month now that the kids are gone. On their spare time they like to take long walks with their dog but in the winter they leave the dog at a friend's and go travel to a warmer country. Both of them have an interest in Salsa dancing and they have been taking dancing classes back home. Their favourite destination is Spain, where they like to spend the days on the beach and in the evenings they usually watch the sunset with a glass of Sangria and then go dancing. One year ago they also got their first grandchild, Wilma and on their spare time they like to spend time with her as much as possible.

In their house they have a big kitchen, perfect for inviting people for dinner, but it is also a nice place to sit and have their breakfast. Three years ago they did a renovation of the kitchen and then they chose to upgrade all their kitchen appliances. Lena has a bad conscience about that because they threw away working products at the recycling. When she thinks back about it she would have preferred leaving them at a flea market for someone else to make use of them.

Their breakfast routines are always the same, Lars gets up first since he needs to be at work before Lena. The first thing Lars does every morning is to put the coffee maker on. He likes to prepare it the evening before so that he can just push the ON-button and then leave the coffee to brew as he does his toilet. Because Lars goes to work before Lena he usually leaves the coffee maker on for her so that she as well will get hot coffee when she gets up. Neither of them brings coffee to work since they are provided with both coffee and tea as much as they want there.

Lena likes to drink both coffee and tea for breakfast but in the evening she prefers tea. This makes her the most frequent user of the kettle. Both the kettle and the coffee maker are always on display and the plugs are always in the outlet. They used to use the toaster more frequently when the kids were younger and still lived at home but now it is stored in a drawer since it takes a lot of unnecessary space in the kitchen. They now only take the toaster out on rare occasions, mostly on weekends to toast fresh bread from the day before.

Stina and August



Figure 4.45, Persona artefact board, Stina and August

Stina and August met two years ago when they both took a course in ecology and evolution at Göteborgs University. They have just moved into their first apartment together in Göteborg. The apartment is located near the town centre but still close to a nature reserve which is very important for them both since they are both interested in outdoor activities in the nature. Having space for a lot of plants in the kitchen is something they both value and even if they live in an apartment in town they try to grow as much vegetables and fruits themselves as they can. Together they are responsible for a cultivation box in a park near to where they live and growing vegetables and fruits themselves is also a way for them to save money. Since August has not had a full time job for a while they need to cut down on as much as they can. Stina works full time as a care assistant but her salary is just enough for the two of them.

Even if the kitchen in the new apartment is quite small they both feel it is perfect for them. They need to think space efficiently and cannot have anything unnecessary on display, because there is not enough space. All free space in the kitchen is occupied by a pot with thyme, rosemary or salvia. Appliances and other kitchen tools, except for the kettle, are being stored in cabinets and

drawers when they are not used. When they moved in together they had double the amount of a lot of product, but they gave them away to friends and family. The things nobody wanted or needed were given to the closes charity collection.

In the morning Stina prefers to sleep as long as possible, which is why she rarely have time to eat breakfast at home. She usually makes a sandwich at home and take it with her. Sometimes she buys one on her way to work where she gets her morning coffee at the local coffee shop. August on the other hand usually sleeps a bit longer than Stina and have breakfast at home. For breakfast he either drinks tea or coffee. If he makes coffee he does it on the stove since neither of them owns a coffee maker or feels the need of owning one. The only appliance on display constantly in their kitchen is the kettle which they use every day to make tea or to pre boil water when cooking. If they boil too much water they usually leave it in the kettle and re-boil it the next time they use it. They believe that since the water reaches 100 degrees and they use it every day there is no risk for contamination. Their toaster is stored in a cabinet and they only use it on the weekends when they have longer breakfasts together. Stina does not like the toaster because she feels as if it is taking much more space than necessary.

Caroline

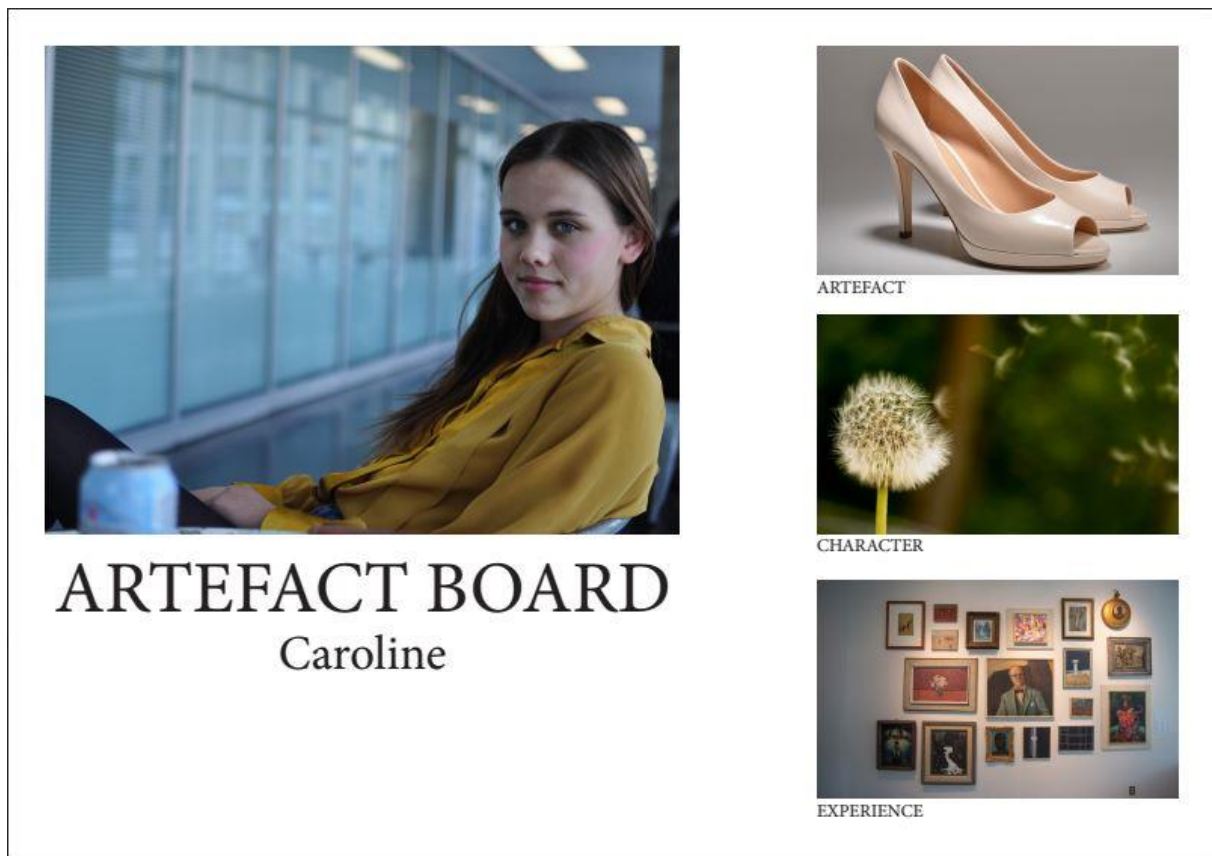

Figure 4.46, Persona artefact board, Caroline

Caroline is a 26 year old student. She is studying to become a pharmacist and has just finished her third year. She would have preferred to continue living with her parents but she had to move to her student apartment because of her studies and the fact that the university was located too far from their house. Nevertheless she is really pleased with her new apartment, she is the first person living there after a renovation and it is located perfectly between the university and the

centre of town. The only negative thing about living there is that the apartment is small and she has to manage everyday life on a student's income.

On her spare time Caroline likes to paint and make her own jewellery. Not a single space on her walls are empty, there are paintings everywhere. The hobby has developed to become an extra income for her since people around her has started to buy both her paintings and jewellery. This extra income, besides her student loan, is good since she has got a big interest in fashion and especially nice shoes. Caroline likes pretty things and does always want to have the latest collection when it comes to both products and clothes. She always buys the latest fashion magazines and cannot wait until she is done with her studies and have a higher income.

In the mornings Caroline always makes and eats breakfast at home before she goes to school. The most important thing in the morning is to make coffee. She usually makes too much on purpose so that she can bring half of the coffee with her to school in a thermos. Even if her kitchen is small, both her coffee maker, toaster and kettle is always on display since she uses them every day. She likes to have toasted bread for breakfast and have the freezer full of ready sliced bread. The defrost function is not something she uses because she believes that it takes too much time, instead she chooses to toast her bread on the same level twice, that works for her. In the evenings she prefers to drink a cup of tea and then she uses the kettle. If she boils too much water she uses it to fill up dirty dishes in the sink. If Caroline had the economical possibility to upgrade her kitchen appliances often she would, just to have the latest and most modern products. The latest products she believes are also the best when it comes to function, they are fast and easy to use.

Findings

When it comes to Lars and Lena some features in the products are more important for them than others. For example since they most of the time have their toaster stored it is important for them that the toaster is easy to store but also easy to move. The toaster should not take up too much space in a drawer or cabinet and even more important, the toaster must fit in standard sized cabinets/drawers. Since Lars leaves the coffee maker on while Lena is still asleep it would create extra value for them if the coffee maker turned itself off after a certain amount of time and if Lars could control the status of the coffee maker (if it is on or off) from a distance. Both the kettle and the coffee maker are always on display and extra value for them would be if the products had an appealing design that showed in a clear way that they belonged to the same collection. Lena would very much like to recycle and enable for reuse of their old products but do not know how but an extra value for her would be to get information and help about how to do this.

August and Stina prefers to have their products stored and not on display. It is therefore important for them that the products are easy to move and easy to store and preferably not take up much space. When it comes to the products that they do have on display, size is very important. They would like a product series that is not too big and clumsy. Stina and August do both have an interest in recycling and reusing old products and knowing that the products they buy are recyclable would create an extra value for them. If they knew that their products were sustainable they would use them with more passion since they are both sustainability conscious. Stina does not have time for breakfast in the morning, therefore a coffee maker that has already made her coffee when she gets up would create extra value for her.

Caroline lives in a small apartment but does still have all products in the breakfast collection on display, therefore space efficient product would be something she preferred. Since she lives

alone and most of the times makes coffee, water and/or bread for herself the capacity of the products could be less. That would make the products smaller and fit better into her kitchen which would create an extra value for her. Because she brings coffee with her every day a feature in the coffee maker that would help her keep the coffee warm and bring it would create extra value.

Discussion

When working with personas and made up users, the personalities created will become a stereotype built upon generalizations. The result from this part should therefore not be interpreted as the reality but instead a possible version of how the reality could be.

4.4.5 Usability tests

To analysing existing products the toaster, coffeemaker, and kettle from the *7000 series* of Electrolux was used, see fig. 3.10-3.15. These products were tested on seven users and the test was executed in three parts described below.

Part 1

The users were instructed to boil/brew/toast a certain amount of water/coffee/bread. They were instructed to use the products according to how they believed that they worked and think about the scenario as a new bought product for their home. They were allowed to use the instruction manual if needed. The users were observed and specific actions were specially noticed and marked on a pre-set checklist. The test was also recorded. See Appendix IV for the entire checklist.

Part 2

The users were instructed to do a specific task connected to a specific product. For the coffeemaker the task was to pre-set the timer on 4 hours and set the aroma strength to medium. For the kettle the users were asked to set the temperature to 80 degrees and make the kettle keep the water warm (use the keep warm function). For the toaster they were asked to heat up an already toasted toast by using the reheat button. See Appendix IV for the entire list of tasks.

Part 3

The participants filled in a Geneva emotion wheel on how they experienced the product and a semantic word scale, Appendix V and VI to see the results.

Findings, Coffee maker

Figure 4.47 shows the results from the usability test with the coffee maker. When analysing the result from the tests it was seen that the interactions with the different measurement systems varies a lot. The different functions except for the ON/OFF button was not used in most cases and there was also no cleaning routines connected to the actual brewing activity. The user was asked to boil a certain amount of coffee, that amount was then measured and as figure 4.48 shows there was always too little coffee brewed.

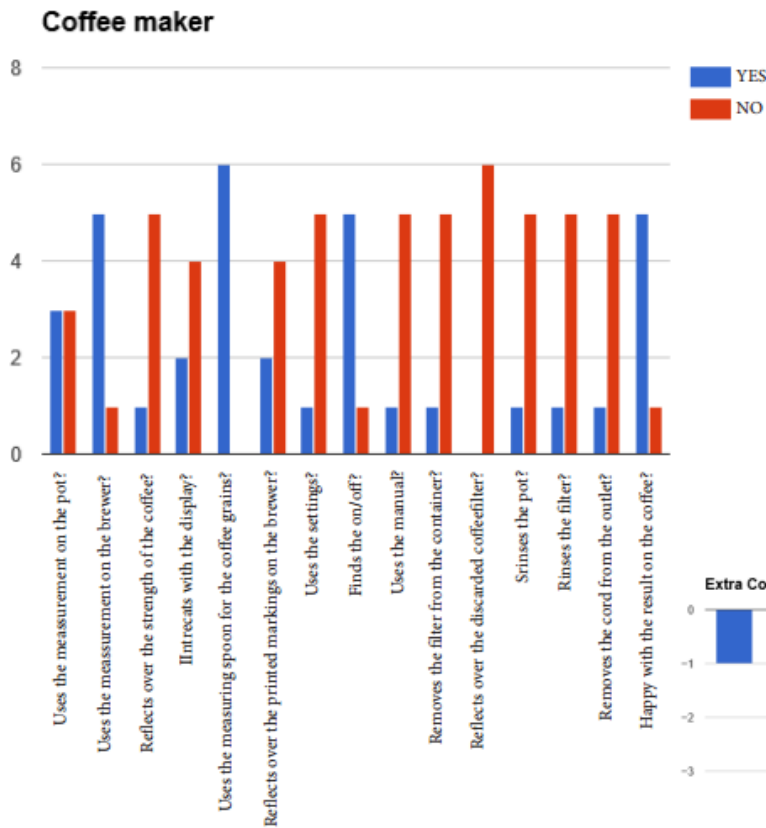

Figure 4.47, Result, coffee maker

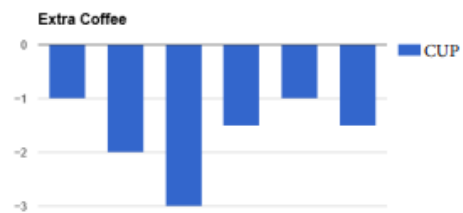

Figure 4.48, Result, amount of cups brewed

General for the coffeemaker was that the product was too high so when the user was to place filter and water into the container the coffeemakers lid hit the above cabinet. The filter was placed in the filter pocket and the amount of grains and water was filled. The water was measured by using the measurements system on the side of the pot and in most cases also on the brewer. The user then turned on the coffeemaker without having to use the manual. After the coffee was brewed the amount of coffee was measured and in all cases there was too little coffee made.

In part two when the user made the specific task the users were supposed to preinstall the coffeemaker to brew coffee within four hours and set the aroma strength on medium. The setting for the aroma was easy for the users to understand but for almost all the participants the manual had to be used for setting the time but in all cases the timer was faulty pre-installed. What the participants did wrong when setting the timer was that they did not set the clock on the coffee maker first. Instead they thought that the timer was to be set according to amount of hours and minutes until it was supposed to start, for example 4h3min. How the timer was supposed to be pre-installed is by setting the time that the coffee maker is supposed to start, for example 21.52.

The emotion that most participant felt towards the coffee maker according to the results from the Geneva emotion wheel was irritation. The coffee maker was also perceived as robust, stable, clumsy and irritating according to the semantic word scales. See Appendix V, for summarized

result concerning Geneva Emotion Wheel and Appendix VI, for summarized result concerning the Semantic word scale.

Some of the comments from the participants when interacting with the coffee maker are summarized in table 4.9.

	<p><i>“Now the question is which one of the indications on the measurement system that corresponds to a normal sized cup?”</i></p> <p><i>“It was a bit too tight under the cabinet, I could not open the lid completely”</i></p> <p><i>“I do not understand this coffee maker completely... but well, well, it has to work anyway”</i></p> <p><i>“A disadvantage with this coffee maker is that I cannot open the lid completely when it’s standing under the cabinet, it just falls down all the time!”</i></p> <p><i>“Now it is on! I think...”</i></p> <p><i>“It’s hard to know, because the symbols are not consistent”</i></p> <p><i>“I have tried all buttons now, I need to use the manual”</i></p> <p><i>“I take a bit more coffee grains than the indication says”</i></p> <p><i>“It is a bit too much water actually but never mind”</i></p> <p><i>“I am not a smart man...”</i></p> <p><i>“Have I started it now?”</i></p> <p><i>“Have I preinstalled it to start at 4am now or in 4 hours? I don’t know...”</i></p>
---	---

Table 4.9, comments from participants, usability test, coffee maker

Findings, Kettle

Figure 4.49 shows the results from the tests with the kettle. Here it is seen that the measurement system is used and there are interactions with the display. For the kettle none of the participants cleaned the product after use. The user was asked to boil a certain amount of water and when they were done this water was measured. Figure 4.50 shows these results. It can be seen that all participants boiled too much water.

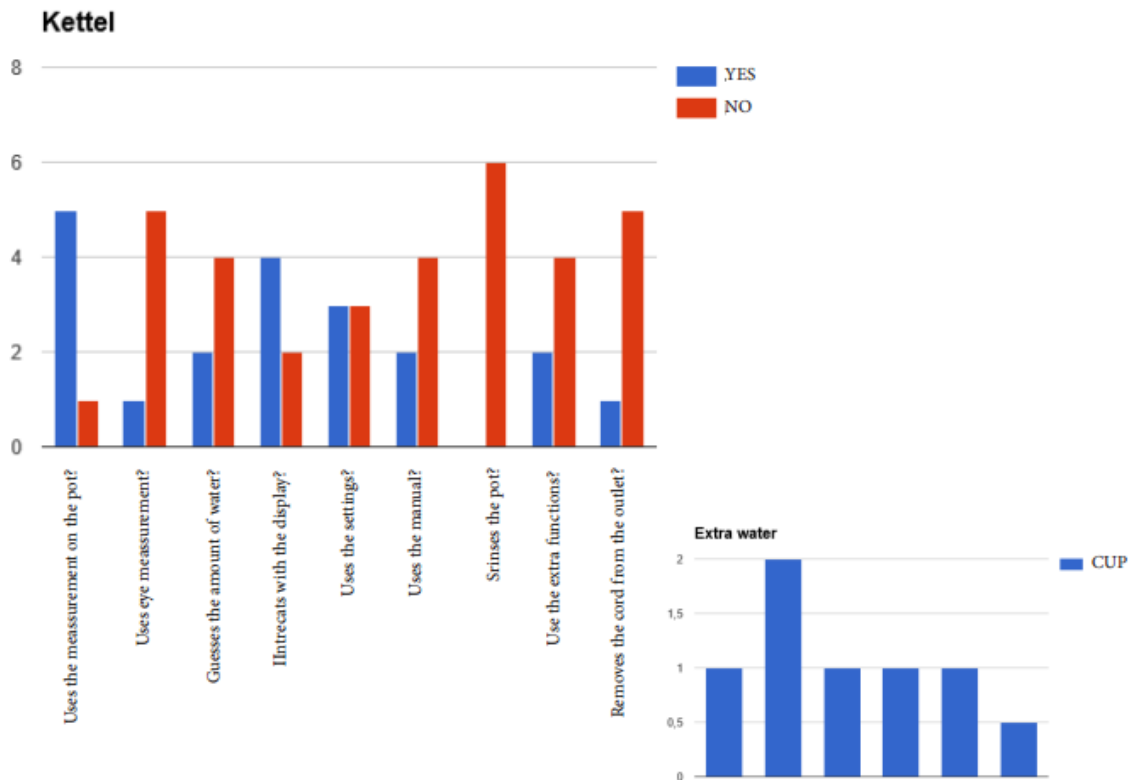

Figure 4.49, Result, kettle

Figure 4.50, Result, amount of cups brewed

Generally the user used the measurement system in the back of the handle of the kettle when filling it with water. The kettle was then turned on by using the display. The setting on the display did confuse the users and in many cases the users did not think that the kettle could be put to 100 degrees and they missed the ON/OFF button. When the water was heated the amount of water in the container was measured and in all cases there was too much water boiled.

The emotions that most participant felt towards the kettle according to the results from the Geneva emotion wheel were pleasure and surprise. The kettle was also perceived as fast, robust and stable according to the semantic word scales. See Appendix V, for summarized result concerning Geneva Emotion Wheel and Appendix VI, for summarized result concerning the Semantic word scale.

Some of the comments from the participants when interacting with the kettle are summarized in table 4.10.

	<p><i>“Maybe I should use the manual, but do I have to?”</i></p> <p><i>“I’m going to use the measurement system more carefully this time!”</i></p> <p><i>“On a scale from 1 to 5 I’m 2.5 sure that I have managed to do the settings right”</i></p> <p><i>“It’s not that many buttons, I should manage to do the settings right, but I’m not sure”</i></p> <p><i>“Ah! This is how many degrees I want the water to be! Can I not get 100 degrees?”</i></p> <p><i>“Have I started it now?”</i></p> <p><i>“It takes some time before you hear the sound that indicates that it is on... so it’s hard to know”</i></p> <p><i>“Aha! It is supposed to be lightened?”</i></p> <p><i>“The display says 0 degrees that cannot be right?”</i></p> <p><i>“No... no I’m not satisfied, I don’t understand what I have done!”</i></p> <p><i>“I don’t understand why it’s on now and why it did not start before”</i></p> <p><i>“Ah, okay, now things starts to happen on the display, then I have done the settings right, I guess... ”</i></p> <p><i>“I really thought that I was supposed to use that button... now I need the manual”</i></p> <p><i>“I just...I just want to see what happens now”</i></p>
---	--

Table 4.10, comments from participants, usability test, kettle

Findings, Toaster

The results from the toaster can be seen in figure 4.51. It can be seen that the functions ON and OFF are used but no extra function, there are no cleaning activity connected to the use of the toaster.

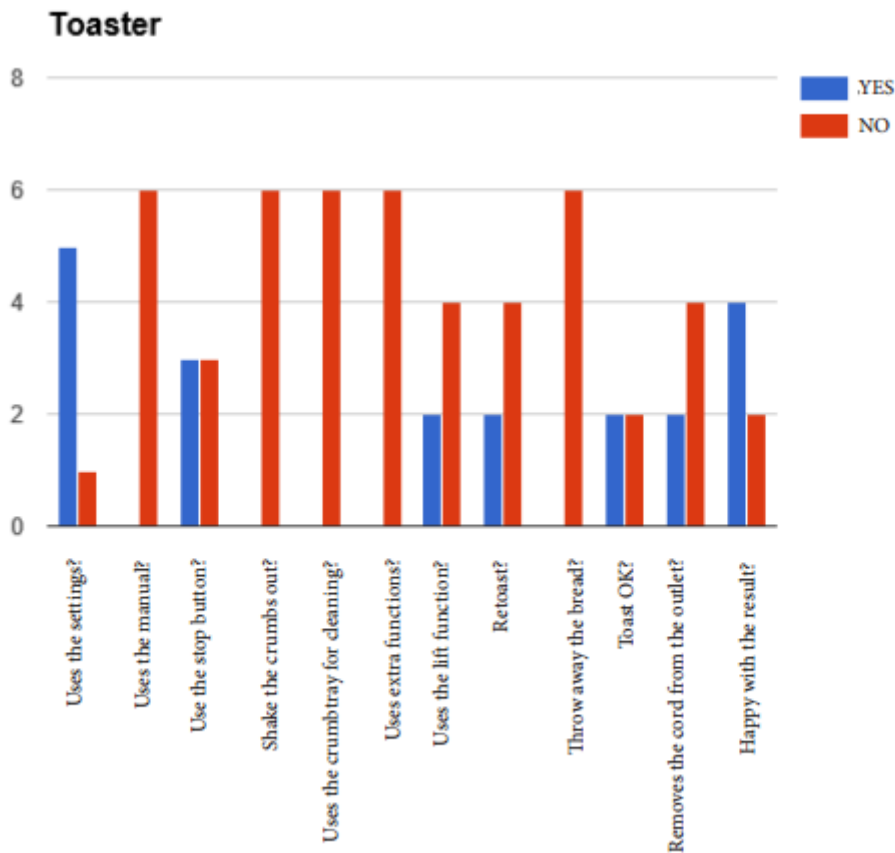

Figure 4.51, Result, toaster

The toaster was seen as the easiest product to use among the three. The bread was put into the toaster and the grading's were set and the toaster was turned on. None of the users used the extra functions and did not see a need for it when asked about it.

The emotions that most participant felt towards the toaster according to the results from the Geneva emotion wheel were interest and pleasure. The toaster was also perceived as calm, robust, stable, trustworthy, safe and easy according to the semantic word scales. See Appendix V, for summarized result concerning Geneva Emotion Wheel and Appendix VI, for summarized result concerning the Semantic word scale.

Some of the comments from the participants when interacting with the toaster are summarized in table 4.11.

	<p><i>“Now as the bread is toasting I would like to double check what the symbols on the buttons stand for in the manual”</i></p> <p><i>“To warm already toasted bread press the...aha!”</i></p> <p><i>“Oh, how dark they became, what a shame!”</i></p> <p><i>“I think I’ll toast another piece of bread for me”</i></p>
---	---

Table 4.11, comments from participants, usability test,

Discussion

The fact that the participants were aware of that they took part in a test and were being recorded might have influenced the results. Even if they were asked to use the products as if they were home people tend to put a bit of extra effort into everything they do when being observed.

4.5 Trend analysis

To analyse existing products on the market, earlier-, old- and future products, a graph was created with the X axis going from conservative to innovative and the Y axis going from sustainable to unsustainable. Images of collected products were placed in the graph where they were assumed to belong in relation to design features and visual expressions. In this way a possibility to visually notice a gap in the area of small household appliances was created. This gave an indication of where the concepts in this thesis work should be placed to fit the project aim and to compete with competitors’ products and Electrolux own products.

Coffee maker

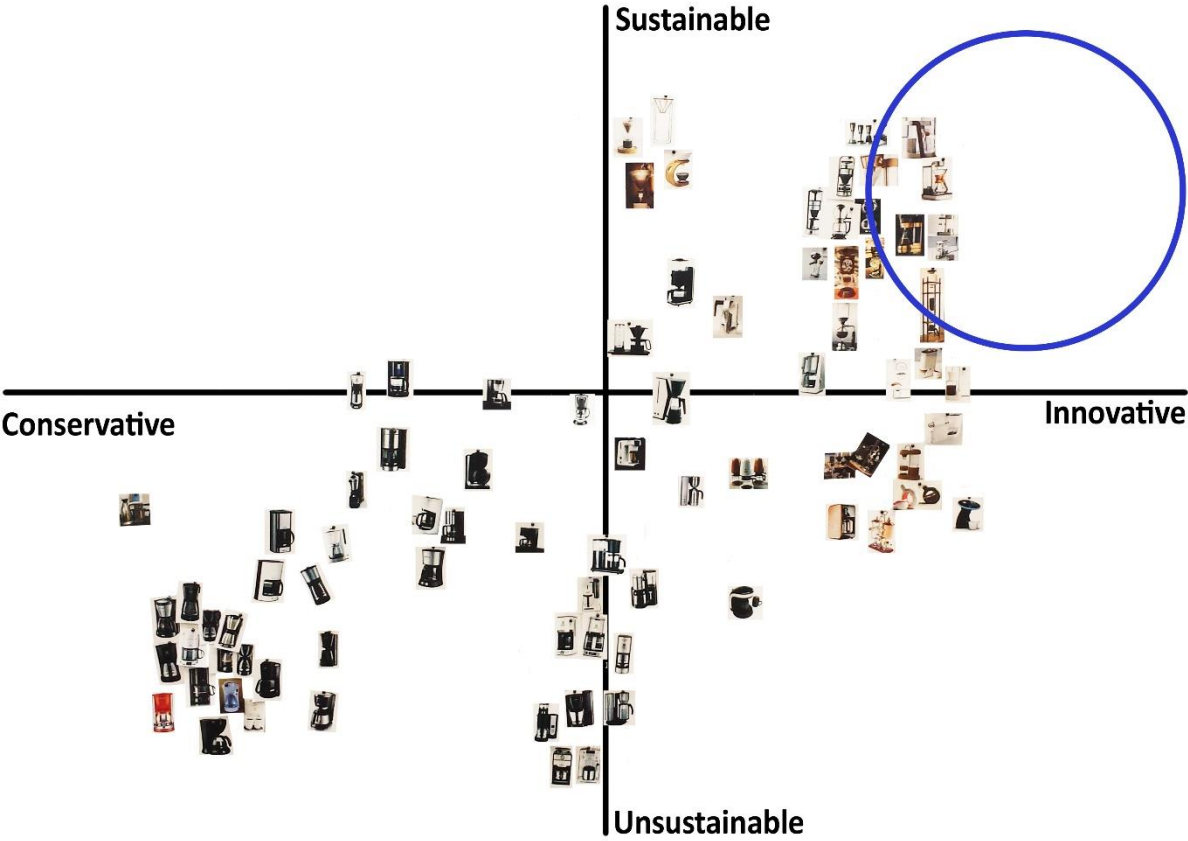

Figure 4.52, Graph with coffee makers

Kettle

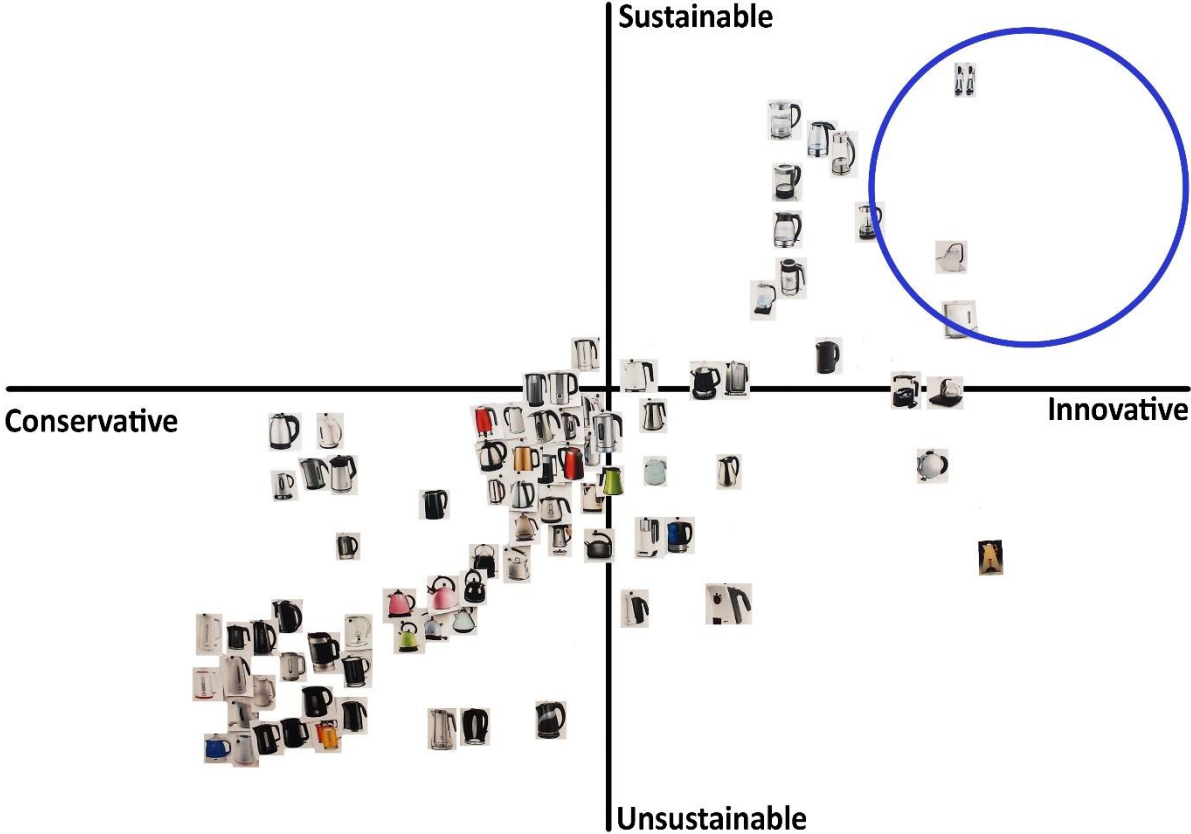

Figure 4.53, Graph with kettles

Toaster

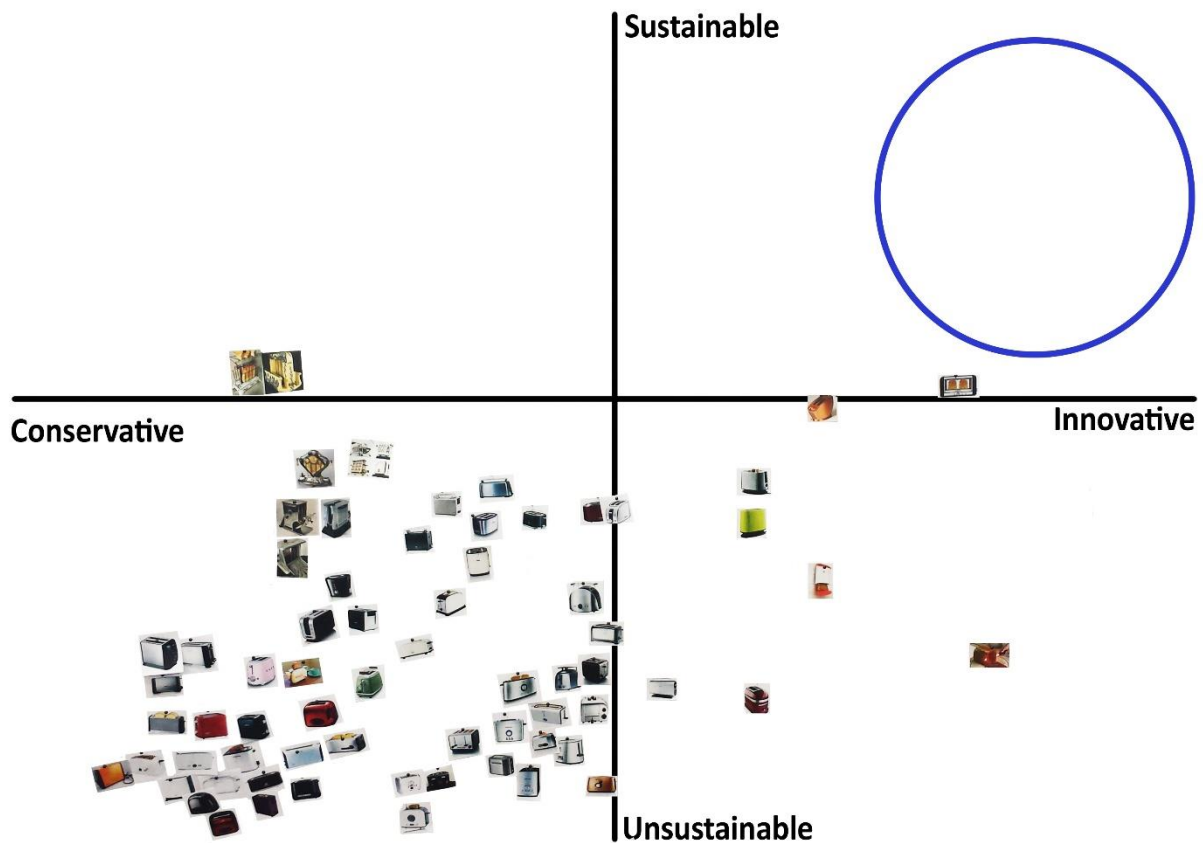

Figure 4.54, Graph with toasters

4.5.1 Findings

When analysing the results from the graphs it was seen that most of the kettles are in the quadrant of conservative/unsustainable, fig. 4.53. There are a spread over the quadrant sustainable/innovative and innovative/unsustainable as well but in a smaller range. This gave a clearer picture that there is a gap in the corner of the quadrant sustainable/innovative which makes it natural for this project to try to end up there when considering the kettles.

For the coffee makers the spread is wider and it is seen that more is done in the sustainable/innovative quadrant compared to the kettle, fig. 4.52 and 4.53. When analysing the brands it is seen that Electrolux own products are clustered in the quadrant of conservative/unsustainable products which makes it relevant for them to try to move from that part to the sustainable/innovative quadrant and try to compete with the other products and brands.

If looking at the toasters most of the products are placed in the quadrant of conservative/unsustainable products and the quadrant of sustainable/innovative is not explored by any products or brands, fig. 4.54. This result shows that the sustainable/innovative category is not fully utilized and gives a great opportunity to focus this project on that area.

This result gives an indication about gaps on the market in relation to sustainability and innovation. It is also an indicator about where Electrolux's products are in relation to both the

graph and competitors and their products are not in the quadrant of sustainable/innovative. Therefore all three products within the breakfast collection should aim to be placed in the innovative/sustainable quadrant to compete with other products and brands and as far in the upper corner as possible to be leading on the market.

4.6 What a designer can change

A categorization of different artefact-related aspects developed by Selvefors et al. (Selvefors et al. 2016) was used during the project to identify relevant aspects from a design for sustainable behaviour perspective. Focus lays on the artefact and on designing products that encourages sustainable activities. This categorization is derived from the fact that behaviours can in most situations not be changed. What one can change is the preconditions for acting and the categorization helps to identify these preconditions. The categorization was used to identify a new and sharper focus area for the project.

The categorization consists of different layers, answering different questions on each layer. The different layers with their corresponding questions are cited below from the article by Selvefors et al. (Selvefors et al. 2016):

Enabled activity, why an artefact is designed in the first place.

- Which activity should be enabled?
- Which motives should the artefact support?
- Which needs are relevant to address?

Artefact type(s), what is to be designed.

- In what way should the motives be supported?
- What artefact can mediate the activity?

Operative functions, what should be designed, in more detail than artefact type.

- Operating concept, how to deliver the main functions.
 - What types and amounts of resources needed?
 - Which type and amount of pollution (waste) is created?
- Practical functions, determine what the user should be able to do with the artefact.
 - What does the user need to be able to benefit fully from the main functionality?
 - What does the user need for the artefact to fit into the activity?

Interactive functions, user's possibilities for interacting with the artefact.

- How should the user interact with and control the artefact?
- How should the user be given access to the functions?

Communicative functions, includes both semantic and syntactic functions.

- **Semantic functions**, describe purpose and mode of operation: express properties, exhort reactions and identify a product, its origin, kinship, location, nature or category.
- **Syntactic functions**, includes the ordering of product form and how to compose perceptual elements to form a whole.
 - How should the user perceive the artefact?
 - How do I want the user to feel when using the artefact?

(Selvefors et al. 2016)

4.6.1 Categorization

Inspired by the categorization in the article “*What a designer can change*” a table was made with a row for each question found in the article and two columns called “*how it is today*” and “*possible changes*”. A table was made for each product and all questions were answered in relation to the statements mentioned above. For example when answering the question “*What types and amounts of resources needed?*” for the coffee maker resources identified were: water, electricity, milled coffee, coffee filter and human effort. Possible changes that were identified in relation to this question were: minimize use of water, minimize use of electricity and reusable coffee filter. Answering the question “*How should the user perceive the artefact*” for the kettle the following were identified for the product today: easy to use, robust, functional, appealing, inviting, safe and flexible. Possible changes were that the artefact should also be perceived as environmental friendly and durable. “*How do I want the user to feel when using the artefact?*” the following feelings were identified in relation to the toaster today: calm, interest, involvement, pride, pleasure, happiness and high control. Identified potential feelings to add were: engaged, committed and dedicated. For a complete overview of the table including the results see Appendix VII.

4.6.2 Findings

Using the method helped develop guidelines and identify potential focus areas related to the products and sustainable behaviour. The focus areas were discussed and combined and resulted in a sharper focus area for the project, which was:

The goal is to create guidelines that support the development of a sustainable breakfast collection. The focus of sustainability will be to reduce waste and engage the users to be more sustainable during use. It will also be to promote compact living by not making the products bigger than necessary to save both material and energy. Sustainability is also something that should be visible in the products expression.

4.6.3 Discussion

Since the categorisation was used in a process of redesign and not in the process of designing a completely new artefact the first two steps in the categorisation did not contribute much to the result. The categorisation did also have to be modified to fit the project better by adding the statements “*how it is today*” and “*possible changes*”. This enabled to answer the questions in two different ways and gave a good indication on where work could be done. The categorisation did very much contribute to the creation of guidelines and is therefore seen as a good tool to investigate what a designer can change in relation to sustainability.

4.7 Disassembly

To visually understand how the product's function a disassembly was made. This was also a way to understand and find the difficulties during this part of the product's lifecycle. The products were one by one disassembled and all the material and parts were documented, fig. 4.55. The disassembly was also used to be able to understand how much space the “invisible” components take up inside the products.

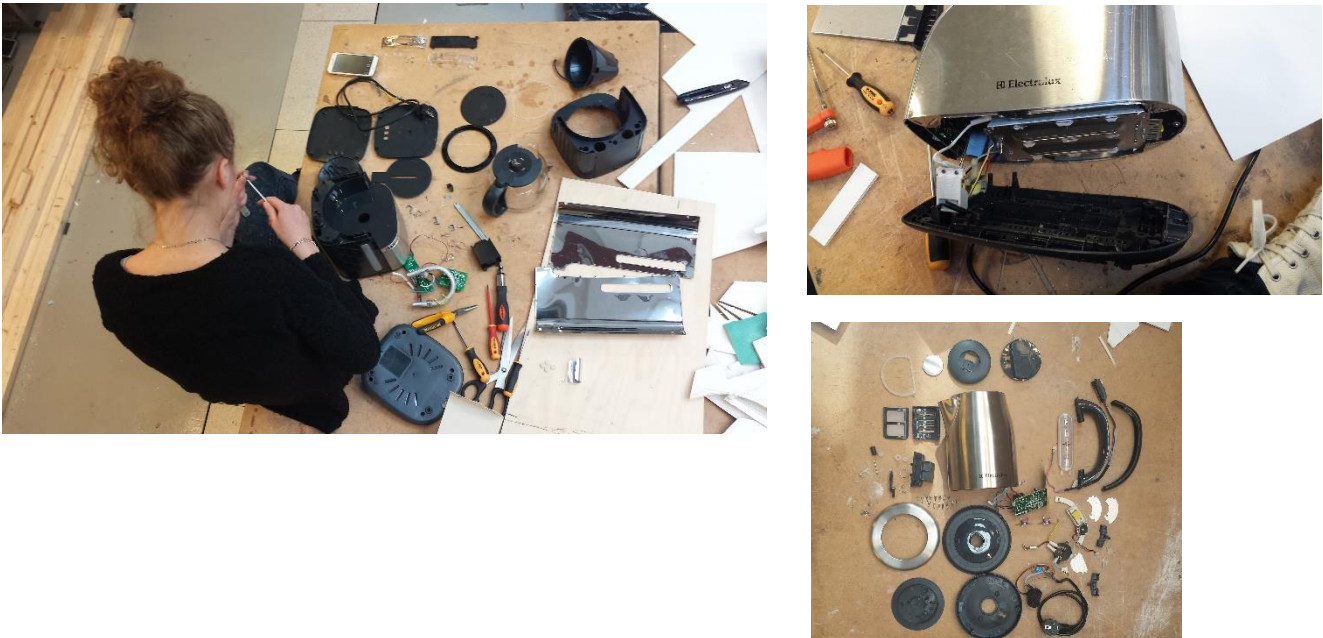

Figure 4.55, Pictures from the disassembly

4.7.1 Findings

Disassembling the three products took approximately six hours for two persons. After these six hours all materials and components were still not separated but clustered in groups, due to difficulties with separating all the parts and material.

Inside both coffee maker and toaster space with only air could be identified. For the kettle these areas were less prominent.

4.7.2 Discussion

The amount of time it took to disassemble the products can be affected by the fact that the two persons disassembling the product had little experience of such activities. The disassembly could also have been more efficient if using assembly (or disassembly) information from the company, no such was provided.

5. List of guidelines

In this chapter the guidelines created during the project will be gathered and summarized in three main categories that will help the company to easily work with Design for Sustainable Behaviour, Green branding and Compact Living.

The guidelines were created from findings and insights during Part 1, *The pre-study*. They are based on information from both Theoretical frame of references and Investigations. These guidelines are supposed to function as a help when developing new products with focus on DfSB, Green branding and Compact living.

Chapter 5 contains the following subchapters:

5.1 Design for sustainable behaviour guidelines

5.2 Green branding guidelines

5.3 Compact living guidelines

5.1 Design for sustainable behaviour guidelines

This chapter will summarize the guidelines developed from the theoretical frame of reference concerning DfSB and describe how these can be applied in the design process. The chapter is divided into nine different parts named Expressions, Measurement system, Use, Feedback, Motivation, Durability, Energy consumption, End of Life and Disassembly. All guidelines with statements on how to fulfil them and examples can be found in Appendix VIII.

5.1.1 Expressions

To capture a sustainable expression in the developed products the following guideline was shaped: *“The products should be designed with focus on sustainable design features”*. This guideline aims to apply sustainability principles on the design to make the product sustainable by giving it design features that have been identified as typical for sustainable products.

Examples of statements to follow to fulfil this guideline are: “The product should consist of materials that are perceived as sustainable” and “The user should understand and perceive that the product is sustainable”. Examples of how to apply this to a product is by using clear and distinct meetings between different materials and to use expressions of simplicity and minimalism meaning that the product should use few details, have visible functionalities, use few materials, few functions and clean shapes and surfaces.

5.1.2 Measurement system

In order to improve the measurement system the following guidelines were created: *“The user should be encouraged to use the measurement system”*. This guideline aims to help the users to boil, brew or toast the wanted amount of water/coffee or toasting grade by encouraging the use of the measurement system. Examples of statements to strive towards when working with this guideline are: “The measurement system should be easy to detect” and “Adopt the measurement system to as many users as possible”. Examples of how to apply this to a product is by making the user understand the consequences of boiling too much water and that the configuration of the measurement system should correspond to what the users expects. For example what their mental model of a cup is.

“Explore alternative ways of designing the measurement system”. This guideline aims to investigate other channels than the measurement system to encourage the user to boil only the amount of water or coffee needed. To work with this guideline the following statements should be fulfilled: “The measurement system should raise the user's awareness about water consumption” and “The measurement system should motivate the user to boil the right amount of water”. Examples of how to apply this to a product is by restricting the user to measure the right amount of water and to investigate systems that help the user to measure the right amount of water.

“The user should have an easy access to the measurement system” This guideline aims to work with the product and the measurement system to enable easy access for the users. To work with this guideline the following statements should be fulfilled: “the measurement system should be easily assessable for the user”. Examples of how to apply this to a product is by enabling for the measurement system to be visible for the users and to place the measurement system in a prominent way.

5.1.3 Use

To improve the use phase and make the use of the product better for the users the following guidelines were created: *“How to interact with the product should be obvious”*. This guideline aims to work with the product's interaction features to make the user able to understand the product, and to use it in the intended and most efficient way. To work with this guideline the following statements should be fulfilled: “Make the interaction with the product obvious” and “Make the users understand the product without difficulties”. Examples of how to apply this to a product is by making the symbols clear for the user and to place and order functions according to cognitive ergonomics.

“The product should encourage to make use of extra coffee or water”. This guideline aims to help the user to make use of the extra amount of coffee or water produced. To work with this guideline examples of statements to fulfil are: “Make the user save the excess coffee or water” and “Enable to keep the liquid warm”. Examples of how to apply this to a product is by incorporating a thermos function or incorporating an easy way for the user to bring the excess coffee or water from home.

“The product should have a flexible interface”. This guideline aims to help the user control the product and make it customized for each consumer without using more technology. To work with this guideline the following statements should be fulfilled: “Make the product adaptable for many users” and “Make the product upgradeable”. Examples of how to apply this to a product is by giving the user the possibility to adopt the functions of the products after desire and to design the product so that the user do not have to keep too much information about the product in their mind.

5.1.4 Feedback

In relation to feedback the following guideline was created: *“The product should give behavioural feedback”*. This guideline aims to give the user behavioural feedback to make them aware of how they act and how it affects sustainability. To work with this guideline the following statements should be fulfilled: “Behavioural feedback should be provided through different channels”, “The product should raise the user's awareness about behavioural consequences” and “The feedback should be optional due to many different preferences amongst users”. Examples of how to apply this is by making a product that should motivate a regular use of the feedback to increase the chance of users adapting to it and use it in everyday life and the feedback should be provided over a longer period of time and preferably on a daily basis.

5.1.5 Motivation

In relation to motivation the following guidelines were created: *“The product should motivate to a more sustainable everyday life”*. This guideline aims to bring sustainability into the user's everyday life to increase the acceptance of a new product that encourages a sustainable behaviour. The product should be used as a way to motivate people to act more sustainable. The product design should motivate the user to create new sustainable norms, attitudes and values. Examples of statements to strive towards when working with this guideline are: “The product design should help the user prioritize a sustainable behaviour” and “The products should not have a negative impact on the comfort of the user”. Examples of how to apply this is that the design features of the product should help the user understand how to use it in a sustainable way and the user should be able to get information about sustainability.

“The product should encourage to discussion about sustainability”. This guideline aims to make the product express sustainability by its design to encourage sustainability discussions. To work with this guideline the following statements should be fulfilled: “The product should be eye catching”, “The products should express sustainability features” and “It should be obvious that the product is sustainable”. Examples of how to apply this is by choosing materials that promotes sustainability.

“The product should motivate to maintenance”. This guideline aims to design the product to help the user extend the product's life by keeping the product in a good condition. Examples of statements to strive towards when working with this guideline are: “Give feedback concerning cleaning and maintenance” and “The product expression should encourage the user to handle the product carefully”. Examples of how to apply this is by designing the product so that it is easy to clean to increase the chance of maintenance.

5.1.6 Durability

In order to approve the durability of the product the following guidelines were created: *“The product should be durable”*. This guideline aims to make products that lasts longer and therefore not become waste too fast. This guideline also aims to meet people's expectations of how long they expect their products to function. To work with this guideline the following statements should be fulfilled: “The product should have a long lifetime”, “Make use of parts and components that are still functioning” and “Use materials that are durable”. Examples of how to apply this is by identifying which parts and components that break and optimize them to last longer.

“The products should have a second hand value”. This guideline aims to make the products last longer and give them a second hand value and to give them a second life. To work with this guideline the following statements should be fulfilled: “The product should age well”, “Worn out components should be easy to replace” and “The product should have a long lifetime”. Examples of how to apply this is by making the product age well, meaning that it does not get permanently dirty and consist of materials that get worn out quickly and to apply design for disassembly.

5.1.7 Energy consumption

In order to improve the energy consumption the following guidelines were created: *“The products should make use of spill energy”*. This guideline aims to make the product take advantage of energy losses. To work with this guideline the following statements should be fulfilled: “Utilize energy losses to give power to other products” and “Reduce running costs for the products”. Examples of how to apply this is by making the product take advantage of energy losses from different surrounding products and to make the products share energy, since all the products transforms electrical energy into heat.

“The products should minimize energy consumption”. This guideline aims to optimize the performance of the products and raise awareness about energy consumption when the products are used and not used. To work with this guideline the following statements should be fulfilled: “The product should be designed to help the users be energy efficient without extra effort” and “The product should be designed to raise awareness about energy consumption”. Examples of how to apply this is by making the energy consumption less in the product all users would be using a sustainable behaviour without having to make a conscious decision.

5.1.8 End of life

To improve the products end of life the following guideline was created: “*The company should take responsibility for their products after end of life*”. This guideline aims to make the company aware of how their products works after the product is not used anymore. Examples of statements to strive towards when working with this guideline are: “Encourage more people to recycle their products” and “Understand how products age, break down and what the most common problems are”. Examples of how to apply this is by designing the product so that it encourages more people to reuse products and give them a second life and by taking care of/be aware of worn out or broken products to make sure that they are recycled the right way or fixed and sold on a second hand market.

5.1.9 Disassembly

To improve the products disassembly the following guideline was created: “*Design for disassembly should be applied*” This guideline aims to design the product with focus on disassembly. To work with this guideline the following statements should be fulfilled: “Make it easy to separate both materials and components”, “Make use of components that are still functioning” and “The product should be efficient to disassemble”. Examples of how to apply this is to make use of components that are not worn out to give them a second life and reduce unnecessary waste and to make the product simple to disassemble to make it easy to repair if broken. This could increase the lifetime of the product and also reduce unnecessary waste.

5.2 Green branding guidelines

This chapter will summarize the guidelines developed from the theoretical frame of reference concerning Green branding and describe how these can be applied in the design process.

These guidelines aim to make green branding a part of the company's core values by designing the product focusing on features of green branding. All guidelines with statements on how to fulfil them and examples can be found in Appendix VIII.

The first guideline created within the field of green branding concerns how to design the product to express sustainability: “*The product should with design features express sustainability*”. This guideline aims to make the products express sustainability through the design and material choices without being labelled as green washing. Examples of statements to strive towards when working with this guideline are: “Use sustainable design features” and “Express sustainability without greenwashing”. Examples of how to apply this is by focusing on simplicity and minimalism to expressing sustainability and on logicity and functionality for an honest expression.

Another guideline created in relation to green branding concerns the products life cycle: “*The products should not become waste to fast*”. This guideline aims to make product life-span longer and decrease the risk of becoming waste to fast. This guideline also aims to make the product's lifecycle more sustainable. Examples of statements to strive towards when working with this guideline are: “The product should be durable”, “The products should be repairable” and “The products should be reusable”. Examples of how to apply this is to design to make it possible to reuse the materials in the products and make the product durable by means of good materials and good manufacturing.

In relation to the product creating extra values for the users the following guideline was developed: “*The product should create extra value*”. This guideline aims to create extra value for the user and the company when owning the product. To work with this guideline the

following statements should be fulfilled: “Create value for the users” and “Understand the needs of the user”. Examples of how to apply this is to investigate what extra value is for the intended target group and to use an alternative shape to challenge stereotypes of what the product looks like to make the user more interested and curious about the product.

The last guideline developed within the field of green branding is the following: “*The product should consist of sustainable materials*”. This guideline aims to design products that are sustainable in their material choices. Examples of statements to strive towards when working with this guideline are: “The materials that the product consist of should be advantageously reusable” and “The materials that the product consist of should not contribute to unnecessary emissions in any steps of the product life cycle”.

5.3 Compact living guidelines

This chapter will summarize the guidelines developed from the area of compact living and describe how these can be applied in the design process. These guidelines aims to help the company to develop products promoting compact living. All guidelines with statements on how to fulfil them and examples can be found in Appendix VIII.

The first guideline developed within the field of compact living concerns optimizing the product: “*The products should be optimized*”. This guideline aims to optimize the product and take advantage of the user's lifestyle and behaviours when designing the products. This guideline also aims to design the products without any unnecessary material, technology or functions to make the product have a minimalistic design for a sustainable expression. Examples of statements to strive towards when working with this guideline are: “The products should take up less space when on display” and “The products should take up less space when stored”. Examples of how to apply this is to make the products smaller to improve compact living and decrease material use and to make the products benefit from each other's forms when standing close to each other in order to be space effective.

Concerning storage of the products the following guideline was developed: “*The products should be easy to store*”. This guideline aims to make the products easy to store when on display, in cabinets or drawers. When it comes to design the products should also be adjusted to small kitchens. To work with this guideline the following statements should be fulfilled: “The product should fit into standard sized cabinets and/or drawers”, “The product itself should be designed to be movable” and “The products should not take up unnecessary space”.

6. Discussion, Part 1

Company comparison

When comparing Electrolux to the companies WMF and Philips that also have a strong sustainability focus, examples of where Electrolux is behind them on the market can be identified. Philips have a sustainable breakfast collection, something that Electrolux does not. A problem was identified with the sustainable collection of Philips and that is the unclear reason to why the collection is classified as sustainable. A possibility for Electrolux to exceed Philips in this field would be to launch a sustainable collection on the market with clear statements of why the collection is sustainable.

The company WMF have a collection on the market called the *KITCHENminis*® consisting of products with less capacity (in the amount of liquid that can be produced at a time) than existing products resulting in that their size can be reduced. This type of collection Electrolux does not have on the market. Electrolux products does all have the approximate same capacity, resulting in them being perceived as big in comparison to the small collection of WMF. The WMF collection does also work for a compact living approach. This collection could work as an inspiration for Electrolux in their continued work with sustainability and compact living.

Focus group

All participants in the focus group could agree on what is perceived as sustainable but still perceive the pictures very differently. Their interpretations of the pictures and products varied but when they got to discuss their thoughts and feelings towards them they had similarities in their ways of reasoning around sustainability. This gives an indication about the difficulty in designing a product that appears in the same way to all people. Sustainable expressions are a subtle matter and therefore whether or not a product is perceived as sustainable lies in the eyes of the beholder. What can be identified are the interpreted features that mediates sustainability but how they are best visualized in a products expression is individual.

When comparing the findings from the focus group with the identified factors from the benchmarking it can be seen that they are very much the same. The identified sustainability features of the pre-study will therefore be considered confirmed.

Survey and interview

According to the survey most people owns the breakfast collection and expects it to last more than 10 years. Most of the participants would not consider to repair their broken products. The toaster is not used in the same range as the kettle and the coffeemaker and that is probably the answer to why the toaster is the one that is most common to store in a cabinet or on a shelf. Comparing the kettle and the coffeemaker the waste of water is much greater using the kettle where most people do throw away the extra boiled water. This could also be a result of the use or misuse of the measurement system.

Comparing the answers from the survey with the answers from the interviews it can be seen that the products in the breakfast collection are all products people usually have in their homes. The toaster is the one that is often stored in drawers or cabinets compared to the coffeemaker and the kettle that is most often on display. The amount of water needed in the coffeemaker is often measured in cups and if there is some coffee left it is usually saved. This compared to the

kettle where the measurements is often used in decilitre or not at all and the amount of water that is wasted is much larger.

A reason why the measurement system is more frequently used when it comes to the coffee maker is that the amount of water in relation to coffee grains will affect the taste of the coffee. When it comes to the kettle it is more often the temperature of the water that might affect any taste of for example tea than the amount of water. This could be the reason that people do not care as much about how much water they boil in the kettle. A challenge is therefore how to make people aware of the negative aspects of boiling too much water and how to make them use the measurement system on the kettle as well.

To maintain the products and extend their lifespan it is important to clean them. It is therefore intricate that people expect their products to last for more than 10 years but do not see the correlation between cleaning and maintaining their products and an extended product lifespan. If people are aware of the correlation between maintenance and lifespan it does not affect their maintenance of the products. This is a design challenge because from a sustainability point of view the longer the product functions the better and less waste is created.

The fact that most participants preferred different kinds of feedback in the interviews verifies the findings from the Chapter 3.1, *Design for Sustainable Behaviour*, saying that different kinds of feedback works for different people. One kind of feedback does not work for all and therefore feedback systems should be flexible for the users to adapt.

Scenarios and user tests

The created scenarios gave a good overview over the assumed critical areas in the use phase and the interviews confirmed the path as correct. One part recognized as missing in the scenario was the cleaning of the products. On the coffeemaker it is done by only rinsing the pot under pouring water, which is a part that also could be included to a critical area of use, and throwing away the filter. These two situations are mostly done when the coffeemaker is used the next time. The part of the reusable filter were not a case at all in the interviews. Cleaning of the kettle was also missing in the scenarios and it was done only by rinsing it under pouring water. In some rare cases they were decalcified. The cleaning of the toaster is mostly done by turning it upside down and shaking the crumbs out.

A critical area recognized in the scenarios was using eye measurement and what effect that would have compared to using the given measurements. During the user test this critical area was identified as false in the case of the coffeemaker. Most people used the measurement systems that was given on the products because this is crucial for the taste of the coffee. When looking at the kettle the estimation of water whether it is with eye measurement or the max and min limits it is clear that more water is poured out. The exact grading when scaling the water is not used in many cases and result in waste of water.

For the kettle the measurement systems were used more carefully than expected in the user tests. According to the results from both interviews and survey the measurement system on the kettle is not used very accurate. This misleading result could be because of the fact that the participants were being observed. A problem that remained was when the users used the measurement system more carefully they still boiled too much water.

When comparing the measurement system on the kettle and the measurement system on the coffee maker their indication on how much a cup is does not seem to correspond. This confused

some of the participants in the user tests. To ease the use of the two products and since they belong to the same collection the indications on the two products should correspond.

In some parts of the user tests it was clear that the users were not pleased with the result of the toasting but they still chose to eat the bread. If they would not have been part of a test, if they were home, some of them would probably have thrown the bread slice away and toast a new bread slice. The extra functions on the toaster was not used (defrost and reheat). When asking about them the participants felt that they were unnecessary and the only function needed was the ON/OFF button and the grading wheel.

PART 2

Idea generation

7. Idea generation, first part

This chapter summarizes the findings from Part 1, *The pre-study* and describes what functioned as the basis for further work through concepts and guidelines, intentions with the concept in relation to the guidelines and important insights. This will give an illustration of how the guidelines could be used through a concept series.

Chapter 7 contains the following subchapters:

7.1 Important insights, basis for concept development

7.2 Intentions with the idea generation

7.1 Important insights, basis for concept development

Part 1, the pre-study, resulted in identifications of problems that are more prominent than others. Most of the problems were mentioned more than once in part 1 which is why they are considered strong and important to focus on. These problem areas combined with the guidelines functioned as a base for further concept development. The purpose with the concept was to visualize how the guidelines could be applied. The problems are gathered below, with factors influencing them stated under each problem.

Measurement system

- Configuration of measurement system
- Placing of measurement system
- Attitudes towards measurement system
- Wrong perception of measurement system

Product expression

- The product is not perceived as sustainable
- The product is not designed with focus on sustainability features
- Intended expression does not correspond to users interpretation

Size, dimensions and capacity

- The product is over dimensioned for the target group
- The product has an overcapacity in relation to target group
- The product is too big for standard sized cabinets and drawers
- The products take up to much space in the kitchen

Creation of extra value

- No extra value is created through the form
- No extra value is added through features
- No extra value is added through the design
- No extra value is created by owning all three products in the collection

Materials and components

- The materials do not express sustainability
- The amount of components are bad from a sustainability point of view

Feedback

- No feedback is given about energy consumption
- No feedback is given about the users behaviours
- No feedback is given about cleaning and maintenance
- No feedback is given about product status

Product end of life

- The product is not designed with focus on design for disassembly
- The company does not have a system for recycling and reusing worn out or broken products

7.2 Intentions with the idea generation

The main intention with the final part of the project was to develop a concept series that could be used to illustrate the guidelines developed in the first part of the project. This was done by focusing on the problem areas stated above and by constant evaluation of ideas against the list of guidelines. In the last part of the project the concept series were used as visualisation of the guidelines.

8. Idea generation

By using brainstorming different focus areas were developed. To further investigate how the focus areas could be applied to a concept series a workshop was held using the idea shift method and line sketches.

Chapter 8 contains the following subchapters:

8.1 Focus areas

8.2 Workshop 1

8.1 Focus areas

As a first part of the idea generation, focus areas were developed using brainstorming methods. The focus areas were developed with focus on solving the identified problems from Part 1 mentioned in Chapter 7, *Idea generation first part*. The focus areas were then evaluated against the guidelines and combined to four more narrow focus areas for the project. Below the different ideas will be described followed by the focus areas.

8.1.1 Service system

The idea of a service system is to encourage more people to recycle their old products but also to reuse products and give them a second life. One example of how this could be done is by giving people discounts on Electrolux products when they leave their old products for Electrolux to make use of. In this way Electrolux can take care of worn out or broken products to make sure that they are recycled the right way or fixed and sold on a second hand market. They could also reuse certain critical or durable parts.

For the company it could be beneficial to see how their products age, how they break down and what the most common problems are. This could help them to improve their products to make them even more durable and sustainable.

The users could benefit from this type of system by being encouraged to leave their old or broken products back to the company for recycling, and not save them at home or leave them at the wrong place. This could make them feel proud and they would also gain trust towards the company for being responsible for their products even after their end of life. This could make the company be perceived as more honest and transparent. The users will also get more value when they get a discount for their old products. This discount could be beneficial for the company since the possibility that the customers will buy their new products from the company will increase.

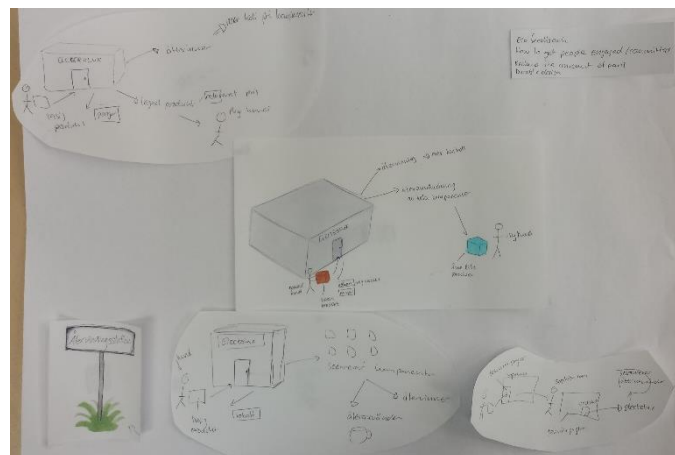

Figure 8.1, Sketches, service system

By applying this idea to a product the following guideline would be met, for the complete list of guidelines see chapter 5, *List of guidelines*:

The company should take responsibility and make use of their products after their end of life

8.1.3 Energy saving system by reusing energy

This idea is about taking advantage of energy losses, most in form of thermal energy, from the different products. One way could be to utilize energy losses from the products to give power to the others. Another idea could be that they share energy, since all the products transform electrical energy into heat. This would enable the users to make use of energy that otherwise would be lost in unused thermal energy. In this way running costs for the products could be reduced and resources saved.



Figure 8.3, Sketches, energy saving system by reusing energy

By applying this idea to a product the following guideline would be met, for the complete list of guidelines see chapter 5, *List of guidelines*:

The products should make use of each other's spill energy

8.1.4 Incorporating thermos functions

It has been seen in the interviews and the survey that people boil too much water and sometimes also brew too much coffee. Instead of trying to stop them from doing so, why not help them reduce waste by helping them save the extra amount of water and coffee? This idea is about incorporating a thermos function into the product that is also possible to take away. This extra function could either be incorporated into the actual product or come as an accessory.

This would be beneficial for the users since they can save hot water or coffee for later and/or take it with them. If they want to they can just keep it warm for a longer period of time. In this way the users might not have to re-boil new water if they realize that they need more water after just a short amount of time. This multi functionality would create extra value for the users. It would also be good from a sustainability point of view since unused liquid that otherwise would have been thrown away can be saved.



Figure 8.4, Sketches, incorporating thermos function

By applying this idea to a product the following guideline would be met, for the complete list of guidelines see chapter 5, *List of guidelines*:

The product should encourage the user to make use of extra coffee or water

8.1.5 Reduced handles

The handle on existing products is a big and prominent part of, especially, the kettle. Does the handle have to be that big, or can the handle be reshaped in order to make the whole product smaller and improve compact living? Maybe the handle could be an incorporated part of the primary form or could it be possible to fold/bend out and in? This could help the user to store the product in a more efficient way. It would also make the product take up less space when on display. One important thing is that reshaping the handle should not make the handling of the product harder.

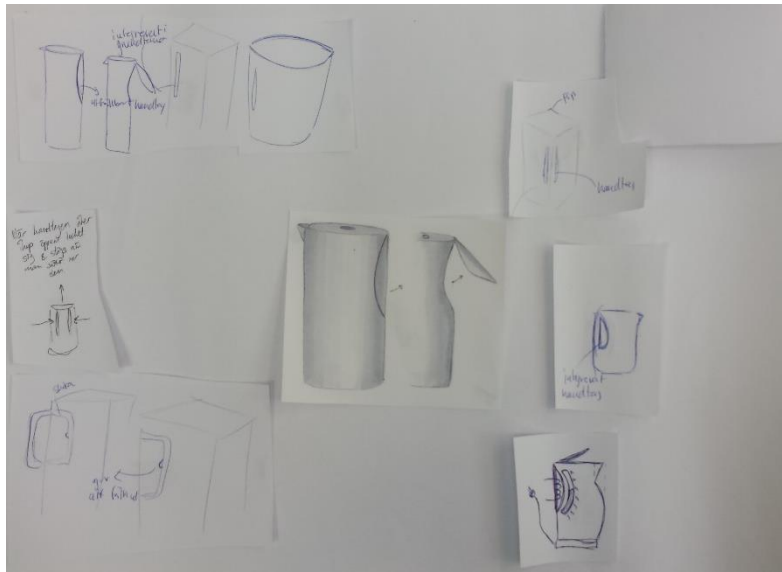

Figure 8.5, Sketches, reduced handles

By applying this idea to a product the following guideline would be met, for the complete list of guidelines see chapter 5, *List of guidelines*:

The products should be optimized through design

The products should be easy to store

8.1.6 Carafe

This idea is to create a slimmer version of the kettle with integrated handle in the neck shape. Since the kettle is meant to be mostly made of glass, alternative measurement systems could be applied using forms on the inside of the kettle. Because of the slim shape the product will also be good from both a sustainability and compact living point of view. Compact living would be promoted because it is smaller and easier to store and takes up less space when on display. Sustainability would be promoted because it is made of less material which would reduce the amount of components that the product consists of.

This product could create value for the user by not only being a kettle but also function as a carafe to serve cold water on the table. The alternative shape and the fact that the product challenges the users stereotypes of what a kettle looks like will make the users interested and curious about the product.



Figure 8.6, Sketches, carafe

By applying this idea to a product the following guideline would be met, for the complete list of guidelines see chapter 5, *List of guidelines*:

Explore alternative ways of designing the measurement system

The products should create extra value for the customer

The products should be optimized through design

and offers. They could remind the users when to maintain their products and how in order to make them last longer, also beneficial from a sustainability point of view.

The users could benefit from always being able to see if their products are turned on or off and even be able to turn them on/off from a distance. This would increase the safety of the products. Using this way of communicating with the users it would also be easier to give them eco-feedback about their use and potential changes. The function could also help the user to measure how much water is in the product or enable for the user to start a timer.

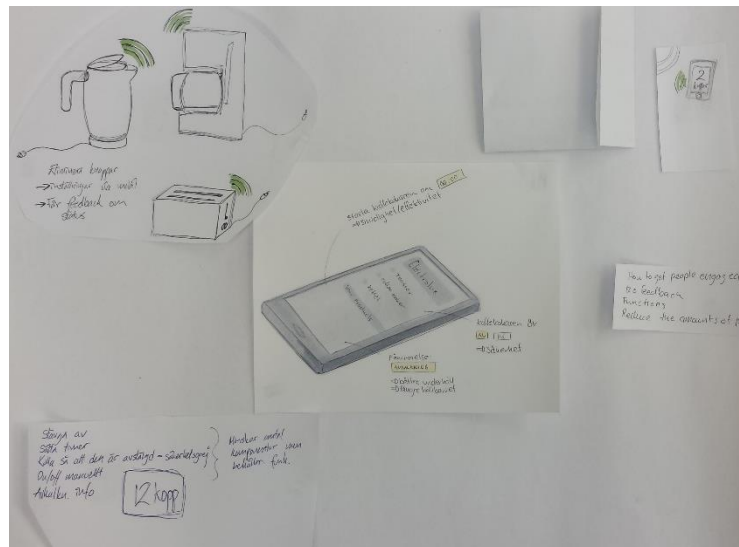

Figure 8.8, Sketches, connected products

By applying this idea to a product the following guideline would be met, for the complete list of guidelines see chapter 5, *List of guidelines*:

The products should be designed with focus on sustainable design features

The product should have a flexible interface to give the user the possibility to adopt the functions of the products after desire

**The product should be able to give behavioural feedback in relation to sustainability
The user should be motivated to maintain the product**

The products should create extra value for the customer

The products should create extra value for the company

The products should use as little energy as possible when in use and not in use

8.1.9 Puzzle

This idea focuses on compact living and the fact that the products should benefit from each other's forms when standing close to each other in order to save space if they are all kept on display. One idea is to be able to combine the products into one but still have them functioning separately. Is one big product with all functions the solution, how big must it be?

Is it space effective if the products can benefit from using the same basis or will it only create problems for the users?

This area focuses on making the products smaller so that the user can have them all on display. In this way the use of the products would be easier since the user would not have to take the products in and out of cabinets or drawers before use. If the products are made smaller the use of material will also decrease.

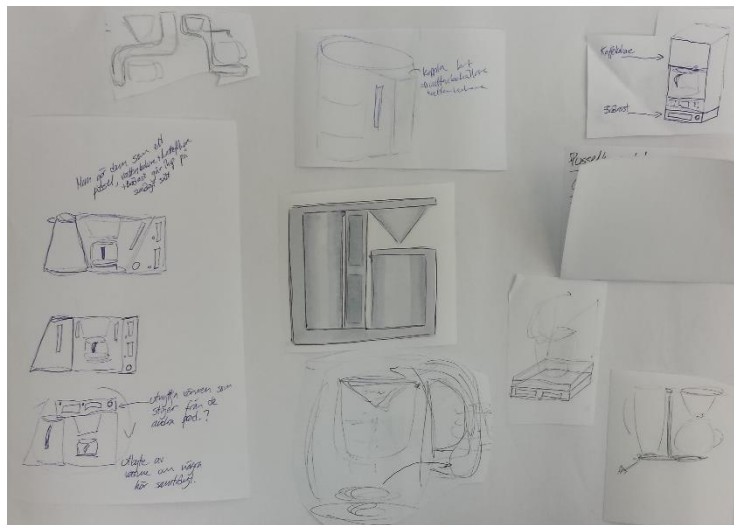

Figure 8.9, Sketches, puzzle

By applying this idea to a product the following guideline would be met, for the complete list of guidelines see chapter 5, *List of guidelines*:

The products should be optimized through design

The products should be easy to store

The products should create extra value for the customer

The product should encourage to discussion about sustainability

The products should be designed with focus on sustainable design features

8.1.10 Mutual parts

This idea is about saving components by creating a common engine that is moved between the products to make them function. Another idea is that the products have something equivalent to a computer charger today, so that they can be charged and then function for a certain amount of time without a cord. This would have to be done by using a battery in the products and from a sustainability point of view, batteries are not to prefer.

A mutual engine part could make the use of the products harder for the users since they cannot use them at the same time. The users would have to be very motivated to accept this fact and aware of the sustainability gains this would bring. Using the products without a cord on the other hand might be seen as beneficial since that enables for the users to place the products wherever they want to. The products would not have to be placed near an outlet. If the user forgets to charge the product it should function with the cord in gear, but the problem with batteries remains.



Figure 8.10, Sketches, mutual parts

By applying this idea to a product the following guideline would be met, for the complete list of guidelines see chapter 5, *List of guidelines*:

The products should be designed with focus on sustainable design features

The product should encourage to discussion about sustainability

The products should be easy to store

The products should use as little energy as possible when in use and not in use

8.1.11 Focus areas

The most interesting areas to continue with were identified using the guidelines and inputs from both the company and supervisors. The areas were combined and divided into four more specific areas. The new focus areas for the project became: Benefit from each other, Minimalistic, Measurement system and Slim design. What the different areas stand for is summed up below.

Benefit from each other

- Benefit from the same basis in order to make them more space effective, compact living
- Benefit from each other in means of form, material, energy, parts, technical solutions
- Reduce parts

Minimalistic

- Enable for the user to start the product from a distance without the timer function as it is today
- Help the user to know at any time that their product is on/off
- Remind the user to clean
- Enable for the user to get Eco-feedback
- Take away all buttons but the on/off button but keep all the functions

Measurement system

- Make it easier to see the measurement system (by not having it behind the handle), placing
- Help measuring the water
- Clear interactions, how to improve the measurement system by design and placing (should not be possible to use them the wrong way, the manual should not be needed)
- Easy to use the measurement system, scale, light, floating things, digital?
- Alternative measurement system, how to measure?

Slim design

- Transparency, perceived as sustainable
- Few materials
- Compact living, less volume
- Alternative shapes, challenge stereotypes
- New form but same function, clever sensors?
- Create value by being able to use the product to other things, kettle and carafe?

8.1.12 Comparison, focus areas and personas

The result from this section can be seen in figure 8.11. In the picture it can be seen that all personas matched with the focus area of a new *Measurement system*. The area *Minimalistic* and *Benefit from each other* worked the best for the persona Lars and Lena but it also worked for the persona August and Stina. The persona Caroline preferred the focus area of *Slim design* and was placed between *Minimalistic* and *Benefit from each other*.

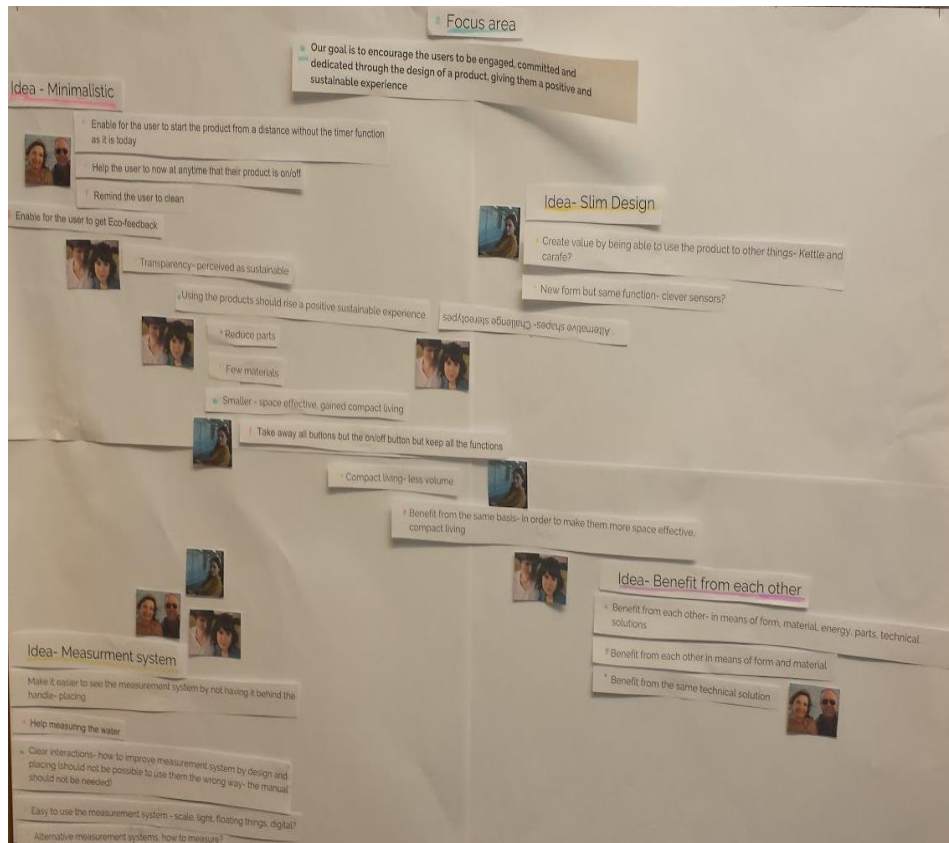

Figure 8.11, Comparison between focus areas and personas

The result shows that the new focus areas includes all personas and can be used in the continued work.

8.2 Workshop 1

The first workshop was created as a way of connecting the focus areas to a product series. The participants in the workshop were presented with two different themes, one at a time, that they were supposed to idea generate around. The two different themes were:

Slim design	Benefit from each other
<ul style="list-style-type: none"> • Alternative shapes, Challenge stereotypes • Compact living- less volume • Create value by being able to use the product to other things, Kettle and carafe? • Transparency- perceived as sustainable • Few materials • New form but same function, clever sensors? 	<ul style="list-style-type: none"> • Benefit from each other in means of form and material • Benefit from the same basis in order to make them more space effective, compact living • Reduce parts • Benefit from the same technical solution

Table 8.1, Themes presented at workshop 1

The theme slim design was presented during the first half hour of the workshop and benefit from each other during the second. The procedure for the idea generation of the two themes were the same. The participants were given a paper with three columns for each product in the breakfast collection, see fig. 8.12. They were asked to sketch according to the idea shift method on all three products (one column at a time). The given time was five minutes to sketch their ideas before the paper was passed on. The paper was passed around to all the participants, until all boxes on the paper were filled with ideas. After this the participants were divided into pairs and were asked to sketch a complete collection (toaster, coffee maker and kettle) inspired by the sketches they had in front of them (two papers per pair). They were given ten minutes to complete the collection. Each pair were then asked to present their collection for the others and give feedback to each other on the collections to create a discussion in the group about the different solutions. This procedure was then repeated for second theme.

THEME	

Figure 8.12, Example of the paper that was given to the participants to sketch on

8.2.1 Findings

The results from the workshop in terms of discussions and sketches worked as inspiration in the continued concept development work. The workshop also worked as evaluation for the second workshop planned at Electrolux with some of their designers. Some of the sketches together with examples of how the participants discussed around them will be presented below.

Sharing energy

The main idea with these sketches were that the products should have only one cord, utilizing and sharing energy. The first sketch is an example of a product tree, where the three products are connected to the same base in order to get energy. The second sketch is an example of a combination product where a kettle and a form of coffee maker has been integrated. These are examples of how the products could benefit from each other.

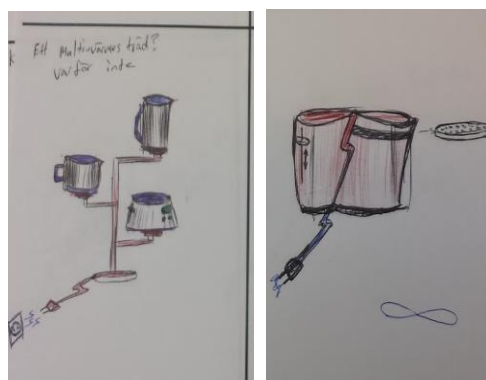

Figure 8.13, Sketches from workshop, sharing energy

Flexible part

These sketches show small and movable products. The idea is to have a small and flexible product that can work in different context. They are also flexible in that they can heat up different things in different containers. For example sketch number one is an example of a movable toaster in the form of a racket. The bread or other eatable is heated by pressing the racket against it. The second sketch is an example of a net-toaster which is also smaller and more flexible. This is a way of making the products more slim and save space.

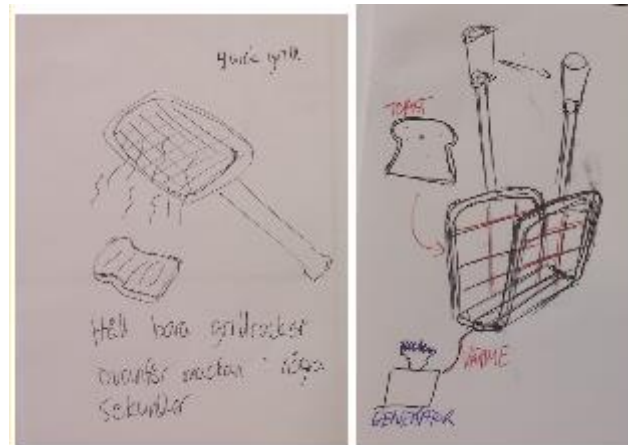

Figure 8.14, Sketches from workshop, flexible part

Adding substance

This idea was to completely eliminate the existing kettle and coffee maker and instead develop other ways of heating water. In this sketch the heating is made by adding a substance to the water which makes it boil. Another idea was to start selling already made coffee in packages where the coffee only had to be heated. The idea is very slim and flexible.



Figure 8.15, Sketches from workshop, adding substance

Combining into one

This idea is about combining the products into one. All sketches show examples of how this could be done by arranging the products on top of each other. The first sketch is an example of a product where all three products in the breakfast collection are incorporated to one. Sketch number two shows a combined kettle and coffee maker that separates hot water and coffee using gravity. The third sketch is a flexible product in that the user can choose whether or not to boil coffee/ heat water in a cup or pot. This is a way for the products to benefit from each other but also to save space.

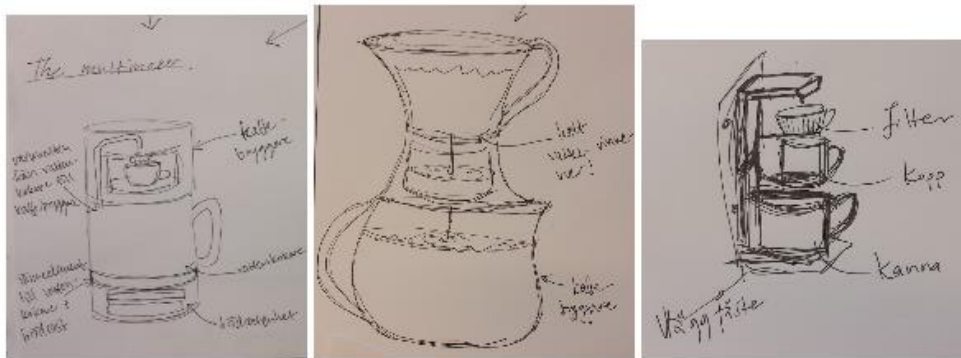

Figure 8.16, Sketches from workshop, combining into one

Utilising form

In these sketches the products does benefit from each other's form and function. This will make the products take up less space when standing together. It's also an effective way of showing that the products belongs to the same collection. Sketch number one is an example where the hot water that the kettle produce is used in the coffee maker as well.

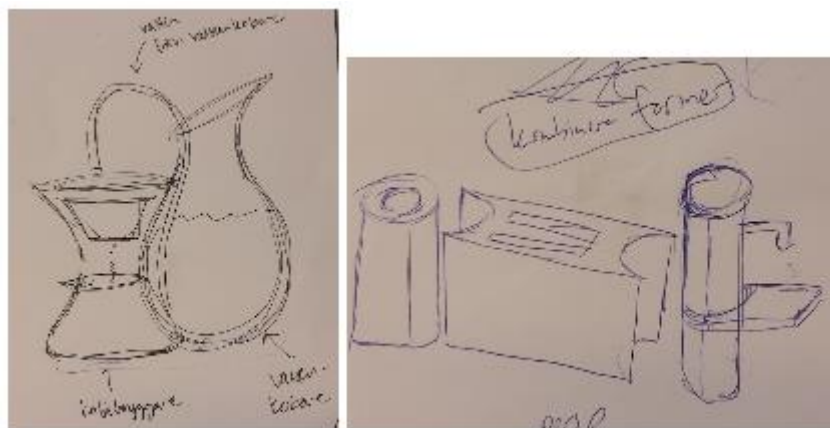

Figure 8.17, Sketches from workshop, utilizing form

Charging energy

This idea is about charging the products with other products or activities. In sketch number one energy is charged when the user bicycles. In sketch number two the energy from when the user showers is used to give power to the coffee maker. This is a way of saving resources and utilize spill energy from other products or save energy produced from other activities like for example exercising.

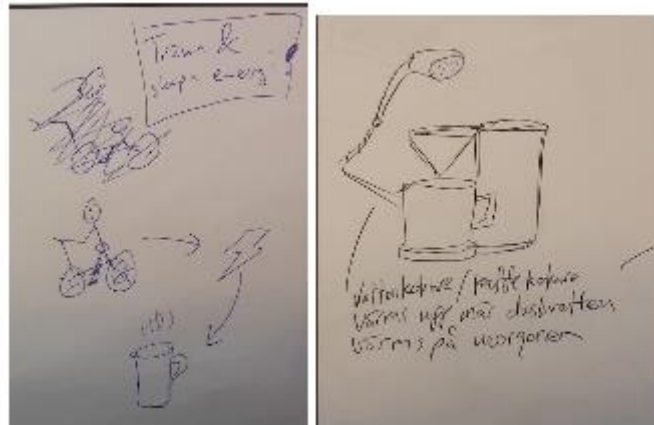

Figure 8.18, Sketches from workshop, charging energy

Using existing products

This idea is about incorporating the products in already existing products. In the sketch a hot water tap has been incorporated in a kitchen. The idea is then that coffee is brewed by adding a component to the tap. The toaster is heated by hot water running through it when the tap is open. This is a way for the products to benefit from each other and use a more slim design.

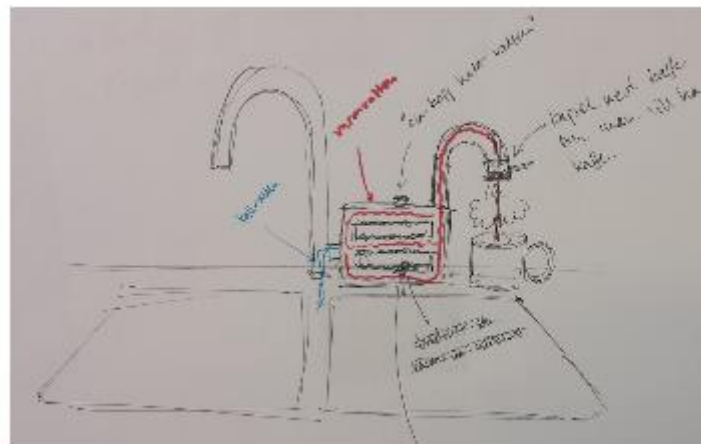

Figure 8.19, Sketches from workshop, using existing products

Common part

This idea is about the products using the same base as energy source. Either by just being placed on a surface that heats the product or by being connected to a separate part. In sketch number one the products are placed on an induction surface that heats them up. In sketch number two the products are also connected to a base but in a different way. In these sketches the products benefit from each other and materials and component can be reduced since they benefit from the same components.

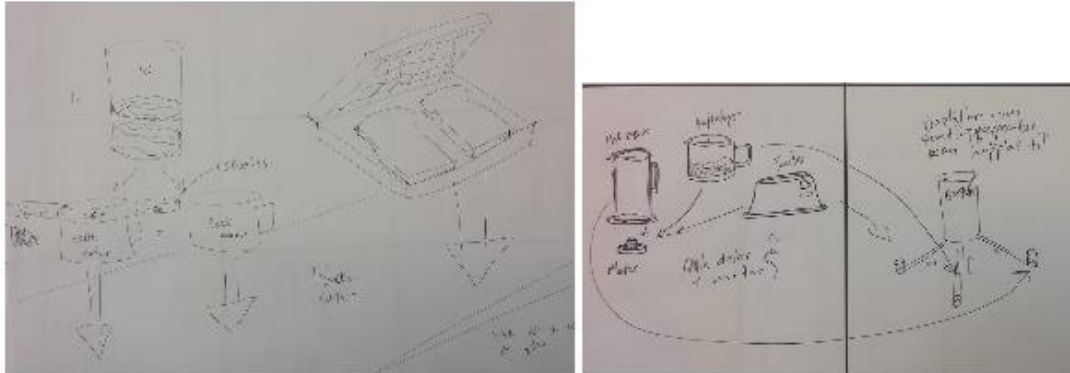

Figure 8.20, Sketches from workshop, common part

8.2.2 Discussion

All participants in the workshop were design students which can have affected the result. Their knowledge in the fields of sustainability and compact living might have enabled for them to interpret and use the themes presented in a desired way.

Workshop is a good way of getting new approaches to existing ideas and to see existing ideas from another perspective. Ideas developed during workshops can function as a help to increase the innovation level of concepts. The workshop should preferably not take more than two hours and breaks are important to incorporate.

9. Concept generation

This chapter aims to describe four concepts generated using the guidelines presented in chapter 5. The methods used during the concept generation are described in chapter 2. The concepts were also based on the focus areas and workshop 1 from chapter 8.

Chapter 9 contains the following subchapters:

9.1 The concepts

9.2 Workshop 2

9.3 Discussion

9.1 The concepts

During the concept generation four different concepts was developed. In order to understand how the concept works, short scenarios are made that describes the process of brewing coffee, heating water and toasting bread. To present the principles of the concepts, line sketches was made. Positive and negative aspects of each concept is also listed and was used for the evaluation of the concepts. Possible challenges of the concepts were also identified and aimed to be used for further development. Each concept is based and developed upon the guidelines described in Chapter 5 and will be presented for each concept.

9.1.1 Concept one

Concept one uses the themes from the focus areas *slim design* and *minimalistic* described in chapter 8.1.11. These are used by minimizing the amount of materials in the product and to gain compact living. The concept builds upon both dual functionality by using one base, and compact living by optimizing the products size and arrangement. The concept can be seen in figure 9.1 and a scenario description of the concept is found in table 9.1.

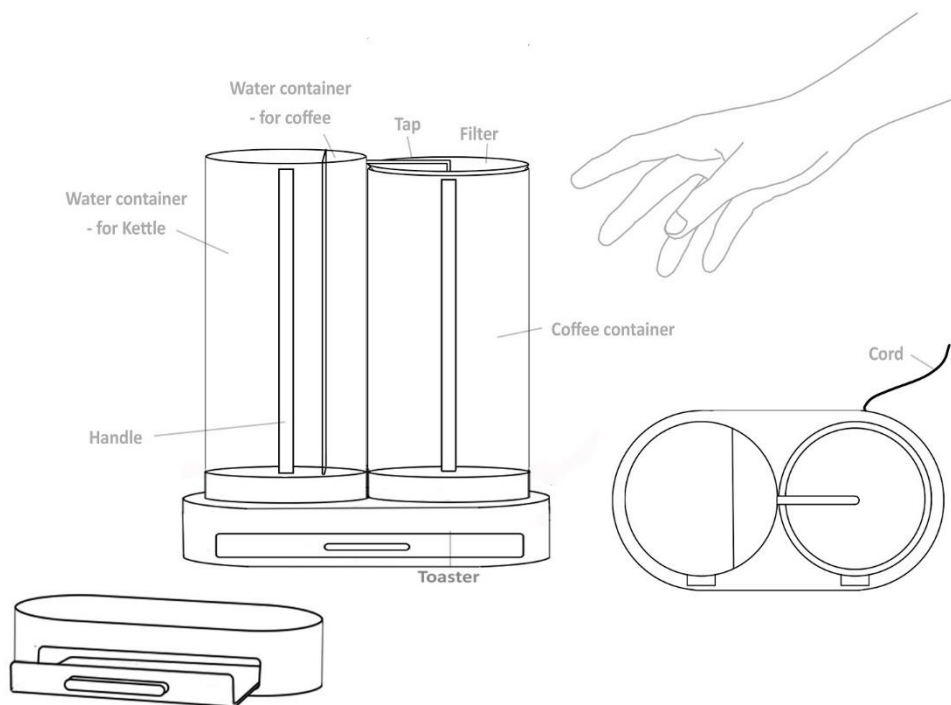

Figure 9.1, Concept 1

Scenario for coffee	Scenario for hot water	Scenario for toaster
<ol style="list-style-type: none"> 1. Water is filled in the water container for coffee 2. Coffee grains are filled in the filter 3. The coffee maker then functions as a coffee maker does today 	<ol style="list-style-type: none"> 1. Water is filled in the water container for kettle 2. The container is placed beside the water container for coffee 3. The water is then heated as in a kettle today 	<ol style="list-style-type: none"> 1. The toast tray is pulled out 2. The bread (or other choices) are placed in the tray 3. The tray is closed 4. The functions are set by the user and the toaster is then turned on

Table 9.1, Scenario concept 1

This concepts was developed by using the guidelines presented below:

The products should be designed with focus on sustainable design features

The concept is a product that is combined into one product with three functions (brewing coffee, heating water and toasting bread). This is done by *Reducing the amount of different materials that the product consists of* and by *Reducing the amount of components that the product consists of*. By combining the functions, components and extra materials can be excluded. By not using a digital display on the concept the amount of energy that the product consumes when on standby by is reduced. Using glass in combination with metal makes the concept consist of materials that are and are perceived as sustainable, as found in the pre-study. The concept has clear and distinct meetings between the different materials and the product is given an expression of simplicity and minimalism by using few details and by using visible functionalities to make the user understand the product. This also gives the products an honest expression when it is focused on meaning focused functionality.

The user should have an easy access to the measurement system

By using a transparent material (glass) on the container the measurement system is easily assessable for the user. By not placing the measurement behind the handle it is also easier to use when it is more visible.

How to interact with the product should be obvious

By not adding any extra functions to the product the user can understand the product without difficulties. The use of few buttons on the product also makes the users less confused.

The product should encourage to discussion about sustainability

Making the product transparent by using glass, the product will get a different expression and can contribute to more attention towards the product which can lead to discussion about a sustainable product. By making the concept a combo product it is also more eye catching when standing together which can lead to discussion.

The products should make use of spill energy

Since the toaster is placed underneath the kettle and the coffeemaker the heat from the toaster can be used as a warming function for the other products by utilizing the energy losses from the toaster.

The product should express sustainability

By using natural forms and materials the products express sustainability according to the results from the pre-study. By creating a combo products the concept is expressing sustainability by focusing on simplicity and minimalism. By making the functions visible to the user the product focus on logicality and functionality which gives the product a more honest expression. By making a combo product the product also focuses on individuality and diversity meaning that the product appeal to many users.

The products should create extra value

The products is given extra value for the user by using alternative shapes to challenge stereotypes of how the product looks like. By using a transparent material the user is able to see and understand how the products functions without difficulties.

The products should be optimized

By creating a combo product the products take up less space when on display, and by using each other's form they can benefit from standing close to each other and become space effective.

Summary

When analysing this concept positive and negative aspects were noticed, listed in table 10.2. Possible changes were also stated used for further evaluation.

Positive aspects	Negative aspects	Possible challenges with the concept
<p>One product combination</p> <p>Takes up less space than the three products separately</p> <p>There are added value to the product when different sizes of breads can be toasted</p> <p>There are added value to the product when also other grocery can be toasted</p> <p>Reduced materials</p> <p>Space effective</p>	<p>Two different heating sources</p> <p>Two different water containers</p> <p>The three products cannot be separated by the user and work on their own</p>	<p>How can the product gain from the heat the toaster exchange?</p> <p>Is the product becoming too high?</p>

Table 9.2, Positive and negative aspects and possible challenges with concept 1

9.1.2 Concept two

Concept two uses the themes from the focus areas *slim design, minimalistic* and *benefit from each other* described in chapter 8.1.11. This has been done by reducing materials, gained compact living, dual functionality and by using the same base for the coffee maker, the kettle and the toaster. The concept builds upon both dual functionality by using one base, and compact living by optimizing the products size and arrangements. The product is given extra value by the idea that the carafe can be used for both coffee, hot water or for serving cold water on the table. Concept number two can be seen in figure 9.2 and a description of the concept is made by using scenarios, found in table 9.3.

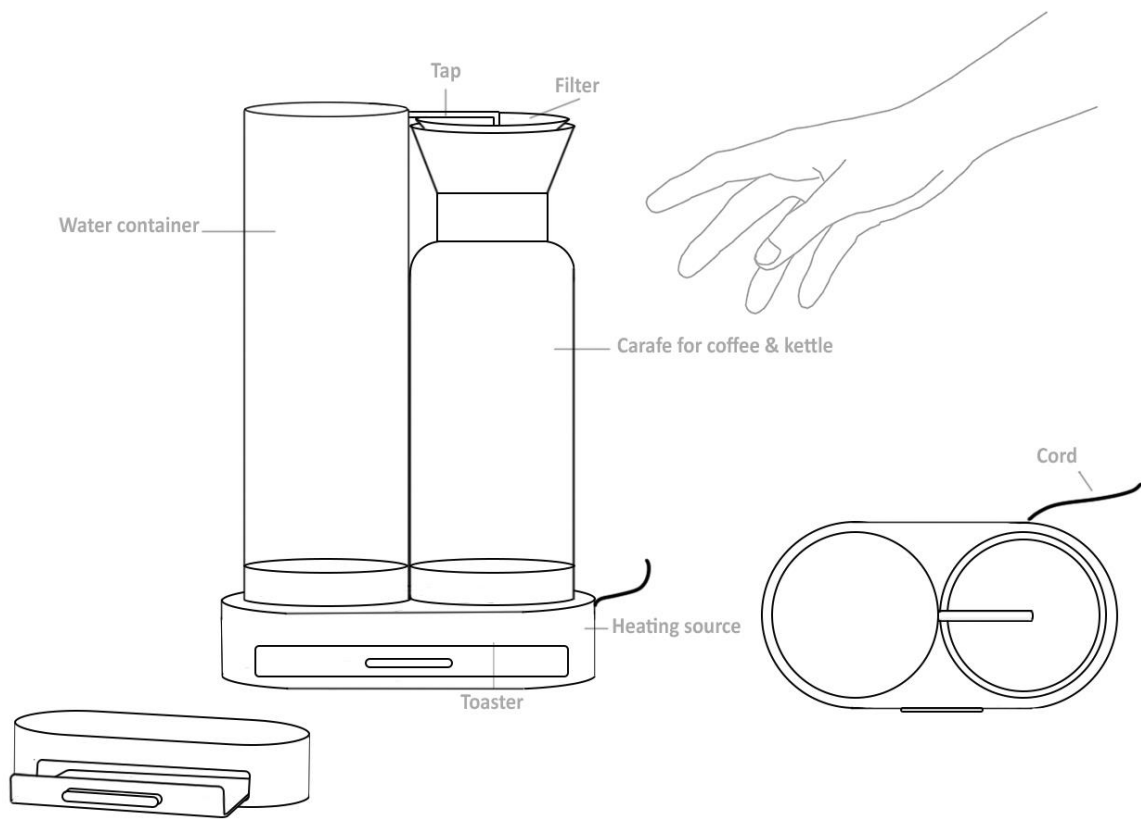

Figure 9.2, Concept 2

Scenario for coffee	Scenario for hot water	Scenario for toaster
<ol style="list-style-type: none"> 1. The right amount of water is filled into the water container 2. The coffee grains is filled into the disposable filter 3. The filter is placed in the carafe 4. Coffee is then brewed according to existing techniques 	<ol style="list-style-type: none"> 1. The wanted amount of water is filled into the carafe 2. The carafe is placed on the “kettle-function” bottom 3. The water is heated as in the kettle today 	<ol style="list-style-type: none"> 1. The toast tray is pulled out 2. The bread (or other choices) are placed in the tray 3. The tray is closed 4. The functions are set by the user and the toaster is then turned on

Table 9.3, Scenarios concept 2

This concepts is developed by using the guidelines described below:

The products should be designed with focus on sustainable design features

By combining the coffee maker and the kettle the amount different materials and components that the product consists of is reduced. By using materials such as metal and glass the product consist of materials that are and are perceived as sustainable according to results from the pre-study. By using the combination of the two materials clear and distinct meetings between different materials gives the product a more sustainable expression and the clear split lines gives the product a feeling of being easier to disassemble. By not using a display on the product the amount of energy that the product consumes when on standby is reduced and by using the rounded form the product is given a more sustainable expression. With features of simplicity and minimalism results in that the concept uses few details and have visible functionalities to make the user understand the product and give a more sustainable feeling. Extra value is given by enabling the product to function in different contexts, by being used as a carafe.

The user should be encouraged to use the measurement system

By making the carafe transparent the measurement system is easy to detect and use in a correct way.

The user should have an easy access to the measurement system

The measurement system is easily assessable for the user since there is no handle that makes the sight more difficult, and the placement of the measurement do not affect the visibility which ease the use.

The product should encourage to discussion about sustainability

The materials choices and material combinations does promote sustainability discussions and the product expressions are eye catching when standing together.

The product should motivate to maintenance

The product expression does encourage the user to handle the product carefully since the shape reminds the user of a carafe when using the carafe shape and the glass material.

The product should express sustainability

The product focuses on natural forms and materials to express sustainability without greenwashing, by using features found in the pre-study. The product also focus on simplicity and minimalism by expressing sustainability according to results from the pre-study.

The products should create extra value

The products creates value for the user by not only serving as the original use but also serve as a carafe that can be used for cold water. An alternative shape by challenging stereotypes of what the product looks like is used to make the user more interested and curious about the product. By combining two functionalities in one, material and components are reduced.

The product should consist of sustainable materials

By choosing glass and metal material the product is advantageously reusable and recyclable.

The products should be optimized

Since the product is made smaller, compact living is improved and the material use is decreased. This makes the product take up less space when on display. The product uses each other's forms when standing close to each other in order to be space effective and are combined into one product.

The products should be easy to store

Since the product is arranged as it is the products does not take up unnecessary space when on display.

Summary

When analysing this concept positive and negative aspects were noticed and listed in table 9.4. Possible changes were also stated for further evaluation.

Positive aspects	Negative aspects	Possible challenges with the concept
<p>One product for all functions</p> <p>Same base for the kettle and coffee maker</p> <p>One water tank</p> <p>Reduced material</p> <p>Reduced components</p> <p>Added value because the carafe can be used for many things (tea, coffee, water etc.)</p> <p>Same carafe for both coffee and tea</p> <p>There are added value to the product when different sizes of breads can be toasted</p> <p>There are added value to the product when also other things can be toasted</p> <p>Space effective</p>	<p>Two different heating sources</p> <p>Uses a disposable filter</p> <p>The three products cannot be separated by the user and work on their own</p>	<p>How can the product gain from the heat the toaster exchange?</p> <p>Does the taste of coffee attach too much to the carafe?</p> <p>Should the product have two carafes? One for coffee one for hot water</p> <p>Is the product becoming too high?</p>

Table 9.4, Positive and negative aspects and possible challenges with concept 2

9.1.3 Concept three

Concept three uses the themes *slim design*, *minimalistic* and *benefit from each other* found in chapter 8.1.11. In this concept two products has been combined into one. It reduces waste and uses an alternative energy source. The product gives extra value to the user by being original and challenges the user to brew coffee in a new way. For this concept two different scenarios for making coffee and hot water has been developed, separating coffee and water in two different ways. Positive and negative aspects were listed for each scenario. Two scenarios were also made for the toaster depending on storage. Concept three can be seen in figure 9.3 and a description of the concept is made by using scenarios seen in table 9.5, 9.6 and 9.7.

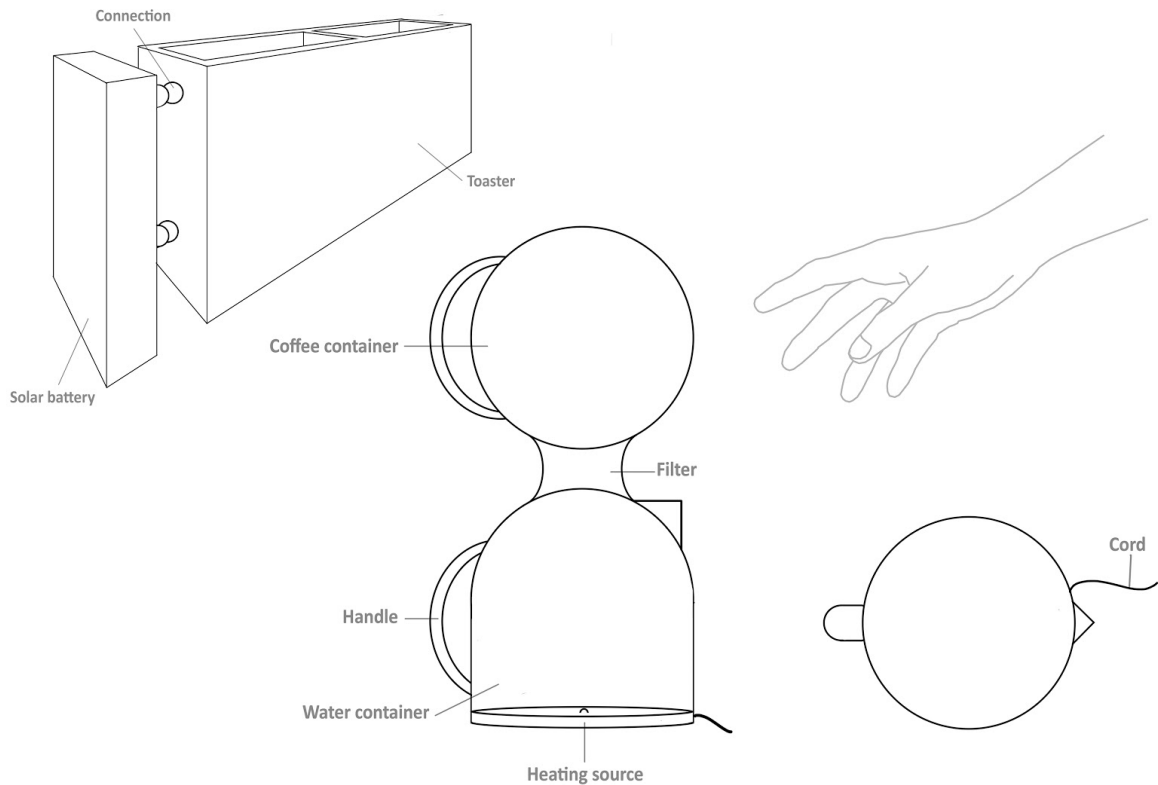

Figure 9.3, Concept 3

Scenario one for coffee	Scenario one for hot water
<ol style="list-style-type: none"> 1. Water is filled into the bottom part 2. The bottom part is placed on the heating source 3. The coffee grains is filled into the top part 4. The filter is mounted on the top part 5. A softer material is used on the filter part to create a tight seal between the two 6. The product uses the normal kettle function 7. The water heats up and is forced up in the top part by the pressure created in the bottom part 8. The water mixes with the coffee 9. When the heat is turned off, gravity forces the coffee mixture back into the bottom part 10. The filter makes sure than no coffee grounds are transferred to the bottom part 	<ol style="list-style-type: none"> 1. Water is filled in the bottom part 2. A lid is placed on the top instead of the filter to seal the pot 3. Water is heated by using the same techniques as today in a kettle

Table 9.5, Scenario 1, concept 3

Scenario two for coffee and water
<ol style="list-style-type: none"> 1. Water is filled in the base part 2. The base part is placed on the heating source 3. The coffee grains is filled into the middle filter part 4. The filter is mounted on the top part 5. A softer material is used on the filter part to create a tight seal between the two 6. The product uses the normal kettle function 7. The water heats up and is forced up in the top part by the pressure created in the bottom part 8. On its way up the water will mix with the coffee in the middle filter part and the liquid in the top part will be pure coffee 9. Only the wanted amount of water for coffee is transferred to the top part 10. The rest of the water will stay in the bottom part and can be used for tea

Table 9.6, Scenario 2, concept 3

Scenario for toaster (stored in a cabinet)	Scenario for toaster (on display)
<ol style="list-style-type: none"> 1. The solar battery is placed on the side of the toaster 2. The bread is toasted with the same functions as today 3. The solar battery is removed and charged 	<ol style="list-style-type: none"> 1. The bread is toasted with the same functions as today 2. The toaster is placed where the battery can be charged daily

Table 9.7, Scenario for toaster, concept 3

This concepts is developed by using the guidelines described below:

The products should be designed with focus on sustainable design features

By using the product as described above and arranging them as in this concept the amount of different materials and components that the product consists of is decreased. The product uses metal and glass which are materials that are perceived as sustainable according to results from the pre-study. By combining glass and metal clear and distinct meetings between different materials are created which gives the product clear split lines connected to disassembly perceptions. The product also have an expression of simplicity and minimalism meaning that the product use few details.

The product should encourage to discussion about sustainability

The choice of materials and material combinations is chosen to promote sustainability. By the products form they are eye catching when standing together which also can lead to discussion.

The product should express sustainability

The product use natural forms and materials to express sustainability according to results from the pre-study. The product also focuses on simplicity and minimalism by expressing sustainability.

The products should create extra value

The products create a value for the user by not only serving as the original use. By an alternative shape it challenges stereotypes and makes users more interested and curious about the product.

The products should be optimized

The products is made smaller to improve compact living and decrease material use by its combo functionality. This also makes the products take up less space when on display. The kettle and the coffeemaker is combined into one product which results in that it consists of as few components as possible. The product only uses the functions needed which makes the amount of electronics in the product decreased.

The products should be easy to store

The products should not take up unnecessary space when on display.

Summary

When analysing this concept positive and negative aspects were noticed and listed in table 9.8 and 9.9. Possible changes were also stated for further development.

Positive aspects, scenario one	Negative aspects, scenario one	Positive aspects, scenario two	Negative aspects, scenario two	Possible challenges with the concept
<p>One product with two functions (coffeemaker and kettle)</p> <p>No disposable filter</p> <p>Same heating source</p> <p>Same heating base</p> <p>Reduced materials</p> <p>Reduced amount of components</p>	<p>New way of making coffee, could be harder for the user to adapt to</p> <p>Cannot make coffee and water at the same time</p>	<p>One product with two functions (coffeemaker and kettle)</p> <p>No disposable filter</p> <p>Same heating source</p> <p>Same heating base</p> <p>Both coffee and tea can be made at the same time</p> <p>Reduced materials</p> <p>Reduced amount of components</p> <p>Space effective</p>	<p>New way of making coffee, could be harder for the user to adapt to</p>	<p>How can we separate coffee and water so that the coffee does not affect the water? For example taste.</p> <p>How can we get a certain amount of water left in the bottom part?</p> <p>Can the solar battery be charged enough for several toasting per time?</p> <p>How to place the top part and the filter when only heating water?</p>

Table 9.8, Positive and negative aspects and possible challenges with concept 3

Positive aspects, toaster	Negative aspects, toaster
<p>New technology for toaster</p> <p>Easy storage (no cord)</p> <p>Smaller</p>	<p>Low innovativeness</p> <p>Does not work when the battery is not charged</p> <p>The product consist of two separate components</p>

Table 9.9, Positive and negative aspects of the toaster in concept 3

9.1.4 Concept four

Concept four uses the themes *slim design*, *minimalistic* and *benefit from each other* described in chapter 8.1.11. This concept is a two in one product that reduces the amount of components and gain compact living. The product is given extra value when the user can use what pot or cup he or she wants. The product is also given extra value when only the right amount of coffee or water is used. Concept four can be seen in figure 9.4 and a description of the concept is made by using scenarios seen in table 9.10.

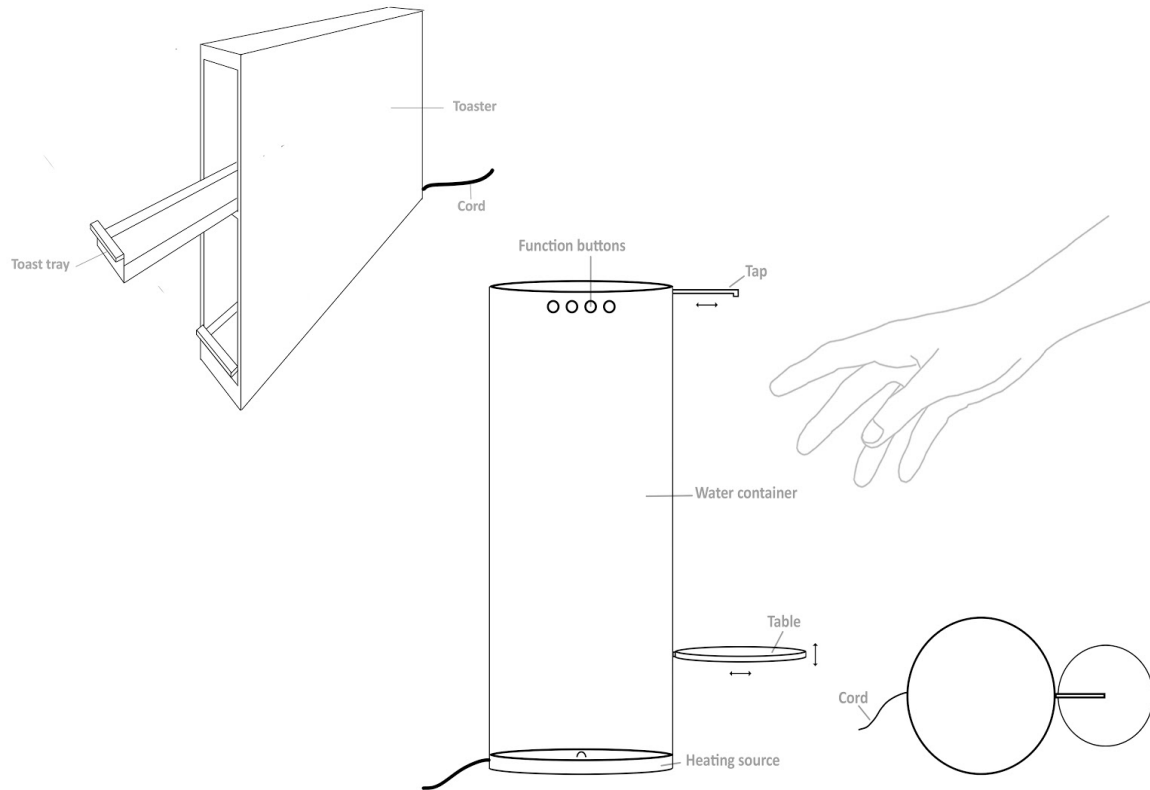

Figure 9.4, Concept 4

Scenario for coffee	Scenario for hot water	Scenario for toaster
<ol style="list-style-type: none"> 1. Water is filled in the water container, no need for the user to measure the amount of water 2. A pot with filter and coffee grains (if it is a mug, carafe or classic coffee pot does not matter) is placed on the movable table 3. The table can be adjusted according to wanted distance to the tap 4. The user can pre-set a certain amount of buttons according to how much water they usually need 5. After pressing the button that corresponds to the wanted amount of water the product itself measures and warms the desired amount of water using the technique of the kettle 6. Hot water comes out of the tap 	<ol style="list-style-type: none"> 1. Water is filled in the water container, no need for the user to measure the amount of water 2. The table can be adjusted according to wanted distance to the tap 3. The user can pre-set a certain amount of buttons according to how much water they usually need 4. After pressing the button that corresponds to the wanted amount of water the product itself measures and warms the desired amount of water using the technique of the kettle 5. Hot water comes out of the tap 	<ol style="list-style-type: none"> 1. The bread is placed in the toast tray (top or bottom) 2. The tray is pulled in 3. The toaster is turned on 4. When the bread is done the tray pops out

Table 9.10, Scenarios, concept 3

This concepts is developed by using the guidelines described below:

The products should be designed with focus on sustainable design features

By making the coffeemaker and kettle into a combo product the amount of different materials and components that the product consists of is reduced.

The user should be encouraged to use the measurement system

The measurement system on the product is easy to detect and increases the possibility of the user interacting with it. The actual configuration of the measurement system is easy for the user to understand and adapt to and the configuration of the measurement system correspond to what the users expects a cup to be, since they can control it by themselves. The products functions are designed with focus on user’s different preferences and is adopted for as many users as

possible. With this measurement system the user is encouraged to use more than the max/min limits.

Explore alternative ways of designing the measurement system

The product uses a measurement system that helps the user measure the right amount of water. The measurement system therefore raise the user's awareness about their water consumption and therefore motivate the user to boil the right amount of water. The product also gives the user the possibility to adapt the system to its own preferences.

The user should have an easy access to the measurement system

The measurement system is easily assessable for the user due to its placement.

The product should motivate to a more sustainable everyday life

The product design helps the user prioritize a sustainable behaviour by the measurement system. The product is time efficient, meaning that using it should not take longer time than using existing products on the market. The product does not interfere with existing lifestyles of the users and does not have a negative impact on the comfort of the user to decrease the risk of the users not adopting to the new product.

The product should encourage to discussion about sustainability

The choice of materials and material combinations is chosen to promote sustainability.

The product should express sustainability

The product should focus on natural forms and materials to express sustainability without greenwashing. The product should focus on simplicity and minimalism by expressing sustainability without greenwashing. The product should focus on individuality and diversity meaning that the products should appeal to many users.

The products should create extra value

Saving material by reducing, or completely eliminate, components such as buttons and wheels for interacting with the products.

The products should be easy to store

The products should not take up unnecessary space when on display.

Summary

When analysing this concept positive and negative aspects were noticed and listed in table 9.11. Possible changes were also stated.

Positive aspects	Negative aspects	Possible challenges with the concept
<p>One product (for coffee maker and kettle)</p> <p>Adjustable to the pots, carafes and cups that the user have</p> <p>The user can by him/herself adjust how much water a cup/pot/carafe needs</p> <p>One heating source (for coffee and water)</p> <p>One heating base</p> <p>Space effective</p> <p>Flexible</p> <p>Reduced material</p> <p>Reduced amount of components</p> <p>The toaster only heats the area where the bread is placed (no necessary heat is wasted)</p>	<p>All water in the tank will be heated</p>	<p>How to transport the water?</p> <p>How to change the speed of the water leaving the tap?</p> <p>How to heat only the wanted amount of water and not all water in the tank?</p> <p>Is it possible to only heat one part of the toaster?</p>

Table 9.11, Positive and negative aspects and possible challenges with concept 4

9.2 Workshop 2

A workshop was held at the company Electrolux together with a design manager, a global project manager, a product design intern, a product designer and a technical expert/development engineer. Before the workshop started, a short presentation was held to introduce the participants to the project and its brief. The workshop was divided into four parts. The first three parts revolved around the developed concepts described in chapter 9.1. Each of the three first parts were structured in the same way, described below in table 9.12. Part number four revolved around two themes described in table 9.13, and an evaluation part where the participants were asked to evaluate both their own ideas generated during the workshop and the presented concepts.



Figure 9.5, Pictures from the workshop

A detailed structure of the planned workshop will follow on the next two pages. Examples of the papers used during the workshop can be found in Appendix IX.

The planned workshop	
Introduction	<ul style="list-style-type: none"> • Project brief
Part one to three (this structure is repeated for all the three parts)	<ul style="list-style-type: none"> • Presentation of the concept • Presentation of theme one, table 9.13 • Idea generation • Creation of collection • Discussion • Presentation of theme two, table 9.13 • Idea generation • Short presentation and discussion for the other participants • Positive and negative aspects with the concepts • Break
Part four	<ul style="list-style-type: none"> • Presentation of theme one, table 9.13 • Idea generation • Presentation of theme one, table 9.13 • Grading of ideas (all ideas created during the whole workshop) • Sum up and discussion about how the negative aspects for the presented concepts could be solved • Comments from participants

Table 9.12, Workshop structure

PART 1-3	
Concept two	<ul style="list-style-type: none"> • How can we change the products (but still keep the functions) so that they become a coherent collection? • How can the exact amount of water be heated? Not heat up all water in the container.
Concept three	<ul style="list-style-type: none"> • How can we get a certain amount of water left in the bottom part? • How can we change the products (but still keep the functions) so that they become a coherent collection?
Concept four	<ul style="list-style-type: none"> • How can we make this concept “Electrolux” in its expression? • How can the heating elements benefit from each other in this concept? Can they be combined into one?
PART 4	
Theme one	<ul style="list-style-type: none"> • How could an alternative measurement system be applied to these concepts?
Theme two	<ul style="list-style-type: none"> • How can the user measure water in a correct and efficient way without it being a classic measurement system?

Table 9.13, Workshop themes

9.2.1 Findings

The results from the workshop in terms of discussions and sketches worked as inspiration in the continued concept development work.

Sketches from the workshop

Below some of the ideas from the workshop is presented, these worked as inspiration for the continued work.

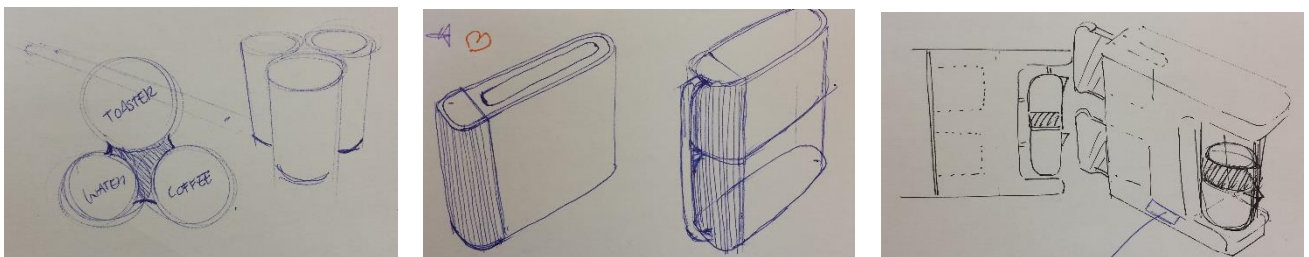

Figure 9.6, Pictures of sketches from workshop 2

During the *creation of collection* part of the workshop the participants discussed the created ideas in small groups of two or three where the best ideas were chosen to further develop into a concept series combining the three products. Below some of the collection concepts can be seen. After the idea generation sessions and the concept creation the concepts were discussed. Some of the comments can be seen below.

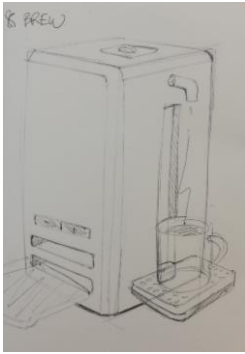

Figure 9.7, Sketch of collection made at the workshop

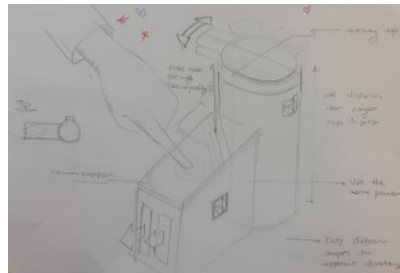

Figure 9.8, Sketch of collection made at the workshop

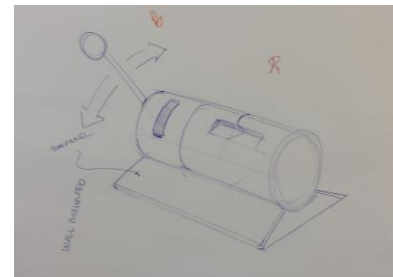

Figure 9.9, Sketch of collection made at the workshop

The concepts in figure 9.7, 9.8 and 9.9 is concepts that builds upon a combo product. During discussion some positive and negative aspects were mentioned for each concept. Negative aspects mentioned in relation to figure 9.7 was that it might take up unnecessary space when having the toaster underneath due to the height. It was also seen as negative that the product had two directions, two surfaces that had to be “free” and could not face a wall or another product for example. Positive aspects around this concepts was that it was nice that they were combined into a combo product since they belong to the same collection.

Aspects discussed around the concept in figure 9.8 were if it is good to have a combo product or not, whether users want to have separate products or three in one. There was also discussions about not using a table for the cups as in concept four, described in chapter 9.1, since it was perceived as unbalanced. Instead the toaster could function as a table and induction could be incorporated in this part. Positive aspects with this concept was that it had a movable tap and could be adjusted to different heights.

The concept in figure 9.9, enabled discussions about whether the product would benefit from using sun panels or not and how a docking station would be used. There was also some ideas around placement of the product if it could be attached to the wall or maybe on the fridge. Negative aspects with this concept was the transition of water that might be problematic. Also if it is attached to the wall there might be dripping problems.

Comments from participants

The participants evaluated and analysed the presented concepts (concept 2- concept 4 described in chapter 9.1) and they wrote down comments connected to the products. In table 9.14, some of the comments are cited.

<p>Concept 2</p> 	<p><i>“It's beautiful to look at but the toaster feels a little bit in the way”</i></p> <p><i>“Very nice idea as it is”</i></p> <p><i>“Maybe transform the water container into a kettle so carafe is only for coffee”</i></p> <p><i>“The water will taste like coffee”</i></p>
<p>Concept 3</p> 	<p><i>“Difficult to adapt to”</i></p> <p><i>“Too complex”</i></p> <p><i>“It is very important to make the water container not taste like coffee”</i></p> <p><i>“The toaster does not belong to the product”</i></p> <p><i>“It is not good with batteries”</i></p>
<p>Concept 4</p> 	<p><i>“Nice idea with the coffee filter on any mug”</i></p> <p><i>“The toaster is very slim, nice but hard to do”</i></p> <p><i>“If you make all the water into coffee the machine would fall over”</i></p> <p><i>“If the container is too big, not easy to carry and pour water in it, then you need extra cups to put water in or if it is t slim, maybe it is easy to fall (unbalanced)”</i></p> <p><i>“Toaster- burn your fingers”</i></p> <p><i>“Toaster- Space effective”</i></p> <p><i>Coffee maker:</i> <i>Instable (-)</i> <i>Space effective (+)</i> <i>Coffee concept doesn't feel so new (products with movable table exist)</i> <i>Unconventional format of toaster→ taking up less space</i></p>

Table 9.14, Comments in relation to the concepts

Insights

After the workshop and inputs given from both the participants and the supervision from Electrolux, the combo product concept was decided to not take any further. This was due to the impossibility to separate the products, which might be unattractive for the users. By having a combo product the price of the product would rise and the possibility to only buy one product from the sustainability collection would not exist. Concept three, described in chapter 9.1, was perceived as the most difficult to adapt to because of its complexity and the new routines that would have to be integrated to the product which was seen as too big of a step. This feedback excluded this concept as well. The feedback from concept two made the features from this concept the most interesting to keep and worked as a base for further development.

9.3 Discussion

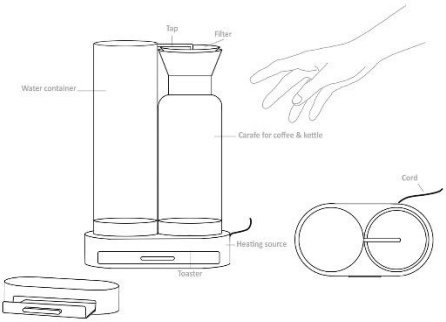
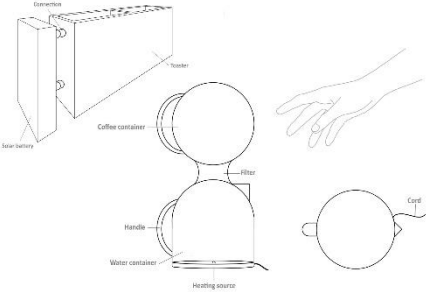
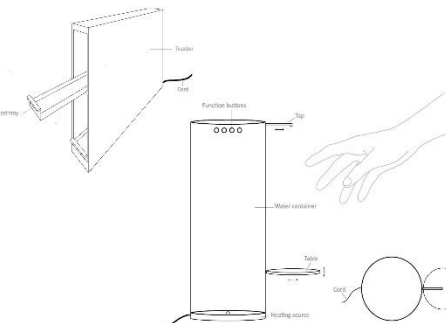
The time that the workshop was held might have affected the results. A Friday afternoon at 13-17 was not the optimum time and due to different influencing factors connected to this the workshop had to be modified during work. For each of the three concept only one theme was presented and worked around to be able to go through all the concepts. The idea generation in part number four was shortened and the time for discussions in the end was also reduced. The background of the participants also influenced the workshop and the results expected. Many of the designers had troubles to idea generate around the more technical themes since they felt that they lacked the technical knowledge needed. The more technical issues and problem with the concepts were therefore almost ignored and made the depth of this input low. If there would have been a possibility for more engineers to join the workshop this might have affected the results of the inputs which would have been valuable for the project.

10. Final concept- How to apply the guidelines to a product series

This chapter will present the concept series that was developed and finalized. To illustrate the developed guidelines a booklet was created where the guidelines together with explanatory pictures and illustrations of the concept will be used. This will give an illustration of how the guidelines could be used through a concept series. The concept and the guidelines will also be evaluated.

Chapter 10 contains the following subchapters:

10.1 The product series

10.2 The booklet

10.3 Evaluation

10.1 The product series

A product series consisting of a toaster, a coffee maker and a kettle was developed to easier exemplify the guidelines. The series was developed with great focus on how to express the findings from the first chapters, the guidelines. The form was first developed using line sketches where the expression was evaluated by nine design students and that was later visualized. All choices in relation to development of the product series will be motivated using the guidelines. Some of the aspects that were more prominent and important to show from the guidelines were: Composition and body shape of the different parts, measurement system, materials and material meetings, an app solution to control the products and product transparency.

10.1.1 The coffee maker

This coffee maker has a capacity of maximum eight decilitres. The transparent parts of the concept is glass, the metal details are stainless steel and the handle on the carafe is made out of wood. To start or stop the coffee maker a button is pressed, the button is located in front of the heating plate. Other settings are made using an app solution, see Chapter 10.1.5, *The app solution* for a more detailed description. Dimensions of the product in millimetres are: height 220, width 80, and depth 145. The intended product expression is sustainability without greenwashing.

The design features kept from the analysis of design features of Electrolux in the pre-study is that the coffeemaker still use a straight silhouette. The top is well defined and the handle is defined using a different material. The button is placed in the front to go in line with the existing products. The coffeemaker use small feet underneath and the use of big radiuses is still kept in the design on the main body. The space for the pot is well defined by using the specific marked out platform for the pot. The pot also have the measurement grading marked.



Figure 10.1, Renderings of the coffee maker

10.1.2 The kettle

This kettle has a capacity of maximum eight decilitres. The transparent parts of the concept is glass, the metal details are stainless steel and the handle on the carafe is made out of wood. To start or stop the kettle a button is pressed, the button is located in front of the heating plate. Other settings are made using an app solution, see Chapter 10.1.5, *The app solution* for a more detailed description. Dimensions of the product in millimetres are: height 215, width 80, and depth 80. The intended product expression is sustainability without greenwashing.

Design features of the kettles for keeping the Electrolux expression are the use of a big and soft handle, well defined with another material. It still have its four main parts, the body, pipe, handle and the bottom part. The lid is well defined as well as the bottom with a change in material or colour. The ON/OFF button is placed in the bottom part.



Figure 10.2, Renderings of the kettle

10.1.3 The toaster

The toaster has a capacity of maximum one standard sized bread slice. The transparent parts of the concept is glass, the metal details are stainless steel. To start and stop the toaster a button is pressed, the button is located on the side of the toaster. When the button is pressed to start the toaster the bread slice is lowered down into the toaster automatically. If the button is pressed to stop the toaster the bread slice is elevated automatically. Other settings are made using an app solution, see Chapter 10.1.5, *The app solution* for a more detailed description. Dimensions of the product in millimetres are: height 155, width 150 and depth 70. The intended product expression is sustainability without greenwashing.

Design features kept for the toaster is the use of big radiuses on the edges and its three main components, the body, the slot for the bread and the area of function buttons. The toasters have small feet.



Figure 10.3, Renderings of the toaster

10.1.4 The measurement system

The measurement system, figure 10.4, uses the same indications as measurement systems does today. In this measurement system the focus is taken away from the max/min limits and instead the user is supposed to focus in the indications in between these. The use of transparent materials makes the access of the measurement system easier from all angles making it easier for the user to detect the measurement system.

The magnet solution, figure 1.5, makes it possible for the user to adapt the measurement system to own preferences by “pre-installing” the amount of water that they usually need. It is possible for the users to mark out their most frequently used amount of liquid on the measurement scale. This is only an example of how a system like this could work and no focus have laid on design or finalizations.



Figure 10.4, The measurement system



Figure 10.5, The magnet solution

10.1.5 The app solution

The products are designed to be plain and the settings are instead made through the user's mobile phone (except for ON and OFF). The idea is that the users can connect to their product on their phones through an application. This would create extra value for both the users and the company since a lot of extra functions could be added to the products without having to create physical interaction possibilities. In this way the company could upgrade and change functions easily. It is also a way for the company to track their users and their habits around the products. The company could present the users with advertisements, tips and offers. They could remind the users when to maintain their products and how in order to make them last longer which is good from a sustainability point of view. Using this way of communicating with the users makes it easier to give eco-feedback about their use and potential changes.

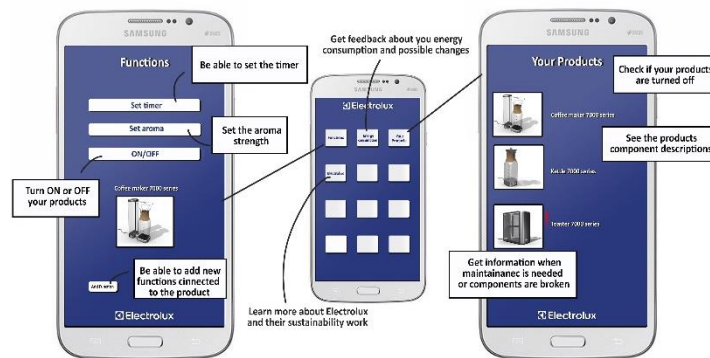

Figure 11.6, The app solution

10.1.6 The cord solution

If the user wants to place all three products together a problem could be how to connect all three products at the same time. Standard kitchens usually have two inlets in relation to countertops. A possible way of solving this can be seen in figure 10.7. The idea is that the products are bought without cords and the user gets to choose before purchase what cord solutions they are interested in. The products could have separate cords, one cord for all three or one cord for two products and one separate. The cord solutions should be possible to change between the products, resembling of how computer cords are plugged in the computer today.

This is one example of how this problem could be solved.



Figure 10.7, The cord solution

10.1.7 The Collection

The three products are formed so that they can stand very close to each other. The use of materials and form indicates that the products belong to the same collection. Dimensions of the collection in millimetres are: height 220, width 230, and depth 150. The intended expression of the collection is sustainable without greenwashing.

There clear signatures for the products repeated in Electrolux design features found in the DFA is still kept in the concept series. The rounded shapes and big radiuses are examples of this but also the changes in material and colour to define a certain function.



Figure 10.8, The collection

10.1.8 The collection in relation to the personas

Here the collection with its new features will be discussed in relation to the personas, their attitudes and values.

Lars and Lena

For Lars and Lena it was important to have a toaster that was easy to store and move. They wanted a toaster that could fit in standard sized cabinets and drawers without taking up too much space. The toaster in this collection has been optimized in size, resulting in easy storage, it is easy to move and the toaster does fit in standard sized cabinets and drawers. The new toaster has been designed with great focus on not taking up too much space which is something that Lars and Lena values.

For Lars, that leaves the house before Lena leaving the coffee maker on, having the possibility to check via his phone that the coffee maker is off, one hour later would create great value. The possibility to turn the coffee maker off through his phone is also something that he would appreciate. Lars would therefore adopt to this new function fast and see the benefits of using it. Lena would like to recycle her old product or give them a second life, but she does not know how to do it. She would therefore appreciate to get this help and information from the company

where she has bought the products. For her it would create great value if the company took the products back and made sure that they were recycled and reused in the right way.

Because Lars and Lena have both kettle and coffee maker on display, appealing design and clear affinity between the products are important for them. This is something that the new collection has, it is clear that the different product belongs to the same collection.

August and Stina

Because August and Stina does not have the products on display, the products being easy to store and move is something that is important for them. It is also of great value that the products do not take up too much space. All products in this collection are smaller than existing products which would create value for this couple. They are easy to move and because of their size they do not take up unnecessary space in drawers or cabinets.

A sustainable collection is something that creates value for August and Stina because they are both conscious about the environment and sustainability. The collection being both recyclable and reusable would make them appreciate the products. Since they are not interested in new products and technology, knowing that the collection is in the forefront of sustainability is what could make them invest in the collection. The collection has an expression of sustainability and can raise discussions about sustainability which are important aspects for Stina and August resulting in that extra value is created.

Since Stina does not have time to brew coffee in the morning, a coffee maker that she could control through an app and set a timer or start while still in bed would be beneficial. Then she would not have to buy coffee on her way to work but could take coffee with her from home. Including the app solution to the collection would help Stina with this and be a feature that could help her see the benefits of always having the coffee maker on display.

Caroline

Caroline's apartment is small and she does not have much free space on the counter in the kitchen. Space in her drawers and cabinets is also restricted. Space efficient products that do not take up too much space would therefore create extra value for Caroline. Smaller products would enable for her to have them all on display but also have the possibility to store them away. This collection is both smaller than existing products, easy to store and do not take up unnecessary space. Therefore this collection would create value for Caroline.

Since Caroline lives alone, she never utilizes the full capacity of existing products, resulting in products being unnecessary big for her. The capacity of this collection would therefore be beneficial for her. She would not need to get products that feels unnecessary big or clumsy.

The size of Carlines apartment restricts her to not own any unnecessary items. The carafe part of the kettle and coffee maker can be used for more than hot water and coffee for example to serve cold water on the table. This results in more benefits with the product than its main intensions, and Caroline can use it in many ways. This would create extra value for her and enable for her to own fewer products.

10.1.9 Benefits with the concept

Form and composition

The three products can be placed close to each other which creates a more space effective solution. The products can be placed close to each other in different constellations since they only have functions on one side and all the other sides have the same form. This promotes compact living.

The final concept consists of three separate products which will save space if the user wants to only have one of the products on display. The user is neither restricted to have the products placed together as a collection. This does also facilitate purchase if the user does not want to buy all three products at the same time. Three separate products are also good from an end of life perspective because if one of the products breaks it is possible to replace only that product. Compared to a combo-product where the whole product might have to be replaced if one component breaks three separate products is better. The products belong together by shapes and becomes a coherent combo product without being attached to each other.

The products are smaller than existing products on the market today which saves both space and resources. The form and size makes it easier to store the products. The use of big radiuses will capture the Electrolux expression.

Measurement system

Since the measurement system of the kettle is no longer placed behind a handle it will be easier to see for the user. In this way the user will be more encouraged to use it. By using transparent glass on the kettle and the coffeemaker the measurement system will be possible to see from all sides of the products which will ease the measuring of the amount of water.

By giving the toaster transparent sides the user can easier control the bread and do not have to re-toast or throw away bread in the same extent as today. The grading is also done through the app solution which enables for the user to adapt the toasting to own preferences and save grading so that it is easy to toast to the same degree every time. By being able to mark out the normal use on the carafe of coffee maker and kettle as well the measurement will be more accurate for the specific user.

Material and Components

Material choices across all three products are in line with green branding since it gives the products a more honest expression. Components are more visible in all products which gives them an extra value when it comes to their expression and green branding. The material choices are within the Electrolux expression.

Since the products are smaller they consist of less material and by only keeping the basic functions (on/off) the product will use less material. All functions, (except on/off) has been moved to be controlled through mobile phones (app), therefore the amount of components has been reduced since many buttons and controls are no longer needed. This is good from a sustainability perspective.

The chosen materials can be recycled which is beneficial from a sustainability perspective and the material choice in the carafes (glass) makes it easier to see the measurement system.

Technology

By only keeping the basic functions (on/off) the product will consist of less technology and by incorporating the extra function to the app, more technology can be applied to the products without adding material and components to the physical product.

To use a cord combination connection will ease the connection in the outlet and enable for the user to connect all three products even if only one outlet is available where the products are placed.

Shipping

Because of the shape and size of the products the packaging will be more effective and therefore ease the shipping by being able to transport more products at a time.

The user

The user is given extra value by the product design that challenges stereotypes and stands out to encourage discussion about the product and sustainability.

The user is given extra value by being able to buy a space effective product, but also by being able to buy the whole series that belongs together. The compact arrangement of the products does create value for the user. By an easy storage of the cord the user will get extra value when storing the products.

The user is given extra value by being able to also use the kettle as a carafe in different contexts. For example to serve cold water on a dinner table.

The user will get extra value from the product by being able to get the new concept app where they can be informed of maintenance, check if the products are on/off, get information about new products, get information about Electrolux work, being able to set the aroma strength, set the temperature, set a timer, get feedback about unnecessary waste, maintenance, broken parts in the product and so on. The users can also benefit from this application by being able to see if their products are turned on or off from a distance. This would increase the safety of the products. By using the app a new behaviour around the products is created and feedback can be given to the users.

Electrolux

With this concept Electrolux will be in the forefront of sustainable products. The concept can be on the market within a couple of years which enables for them to fill a gap that exists on the market today. The concept expression does also fit within the Electrolux line.

10.1.10 Future challenges

Further investigation on whether or not it is possible to create products that are this small is needed. This example collection is based on assumptions about size of components in relation to the size of the components in the reference collection. If the components can be compressed this much would have to be further examined.

A future challenges is how to print the measurement system on the carafe without the risk of it wearing of too fast. On the pot of the coffee maker today, a measurement system is printed and one way is to print the measurement system on the carafes the same way. But this is something that has to be further investigated.

Another challenge with this collection is cleaning and hygiene. In kettles it is common that a lime deposit is created after a certain amount of time and for coffee makers it is hard to discard the coffee taste from the pot. This results in a problem to use the carafe in this collection for other things, for example serving cold water on the table. It does also create a need for cleaning facilities. If the neck of the carafe is too slim for a normal sized dish brush it is possible to use a bottle-brush instead. Further investigation on how to clean the products is needed.

One possible future for the carafe is to sell it as a separate product. That would extend the collection but also create value in that the users could buy a new carafe for their coffee maker if the first one breaks. It does also enable for the users to own a carafe without the risk of lime deposits or coffee taste if serving cold water on the table.

10.2 The booklet

This part of the result is a visualization of the booklet made for the company that would serve as an inspiration to use when working with product development within the areas of Design for sustainable behaviour, Green branding and Compact living. The booklet also brings up recommendation areas for Electrolux to bring into their design work and product development.

Some examples from the booklet will be presented below.

10.2.1 Design for sustainable behaviour guidelines

This chapter contains the guidelines developed from the area of Design for Sustainable Behaviour and describes how these can be applied to products and brought into the design process.

The chapter is divided into nine different parts. Expressions, Measurement system, Use, Feedback, Motivation, Durability, Energy consumption, End of Life and Disassembly.

Expression

The products should be designed with focus on sustainable design features

This guideline aims to apply sustainability principles on the design to make the product sustainable by giving it design features that have been identified as typical for sustainable products.

To work with this guideline, strive towards fulfilling the following statements:

- Reduce the amount of different materials that the product consists of.
- Reduce the amount of components that the product consists of.
- Apply design for disassembly.
- The product should consist of materials that are sustainable.
- The product should consist of materials that are perceived as sustainable.
- The user should understand and perceive that the product is sustainable.

Examples

- Use clear and distinct meetings between different materials.
- Use clear split lines.
- Use good contrasts between materials.
- Avoid cheap plastic parts.
- Use easy and simple shapes.
- Give the product an extra value by being upgradeable and the possibility of having a second life.
- Give the products extra value by enabling for the product to function in different contexts.
- Use expressions of simplicity and minimalism meaning that the product should use few details, have visible functionalities, use few materials, few functions and clean shapes and surfaces.
- Give the product an honest expression, meaning focusing on logicity and functionality.

Apart from components and electrical equipment's that has not been considered in this analysis the products main materials today are stainless steel, plastics and glass. The material in focus of reduction has been the plastic and as can be seen in the picture below (figure 11.8) the plastic parts has been eliminated. The amount of stainless steel has been reduced and instead the amount of glass has been increased.



Figure 10.8, The reference product and the concept series

With a new measurement system the user should be encouraged to use the indications between the max/min limits instead of the max/min limits. In this example (figure 10.9) it is done by emphasizing the indications between the limits by making them bigger. The goal is to draw the user's attention away from the max/min limits and towards the more specific indications. By doing this the amount of water wasted can be reduced.



Figure 10.9, The measurement system

By enabling for the user to follow the toasting the amount of bread slices toasted in an unwanted way can be reduced. In this example (figure 10.10) this is done by incorporating a glass part to the toaster. This makes the user able to see the bread slice during the toasting and cancel if they consider the toasting done. The amount of bread slices thrown away will be reduced.



Figure 10.10, The toaster with transparent glass

Adding more functions to the products has in the analysed product resulted in adding components and more materials. By transferring functions into an app connectable to the products, materials and components can instead be reduced. Therefore the level of sustainability increases.

By incorporating product functions in an app the upgradability of the product can also be simplified. Upgrading the product can be controlled by the company from a distance. This would give the product extra value and expand the product's life. See example in figure 10.11



Figure 10.11, The removed functions and the app example

How products are perceived by the users differs between users. Products experienced as sustainable does have key features. An example of such features can be seen in the picture below (figure 10.12) and some of the features are listed below.



Figure 10.12, Items perceived as sustainable

- Few materials and simplicity as in few details with visible functionalities for easy understanding of the product.
- Honesty as in visible and clear functionality and components.
- Easy handling as in easy to understand for the user.
- Few details as in clean surfaces with few interruptions.
- Raw materials as in copper, glass wood and vegetation.
- Nudity and hygienic as in unadorned, simple and plain surfaces with dove colours.

- Visible functionalities as in clear split lines and material transitions around function areas.
- Function based as in products only doing what they are supposed to, no extra irrelevant functions are added.
- Minimalistic as in few details and visible functions.
- Reusable and recyclable as in durable, materials that age well, few material combinations and no complex surfaces with different materials integrated.
- Luxury as in clean surfaces, few colours and durable materials.
- Calm expressions as in few details and simple transitions.
- Earth as in warm colours and earth materials such as wood.
- Informative as in distinct, little but prominent information, few details.
- Clear contrasts as in prominent material meetings and surface transitions.
- Clean shape as in few details and matt surfaces.
- Basic geometries as in simple transitions and forms.
- Friendly as in rounded shapes

There are many ways in which sustainable expressions can be captured. One way is to work with materials, in this example glass and wood that are perceived as sustainable (see figure 10.13). Another example is to work with salient contrasts, distinct meetings and clear split lines between materials and here you can see examples of this in the meetings between steel and glass, and glass and wood. Simplicity and minimalism does also mediate a sustainable expression. In this examples these features has been captured by reducing the amount of functions and material meetings. Sustainability can also be mediated by giving the product an honest expression. An example of this is the use of only one button on all products and by enabling for the users to see the functions, for example the pipe of the coffee maker.



Figure 10.13, The kettle and the base of the coffee maker

Extra value can be created by enabling for the product to function in different contexts. An example is the carafe shape of both coffee maker and kettle, the carafe can be used for both hot and cold water for example on a dinner table. This is also good from a compact living perspective where people would need less amount of products if they were multifunctional.



Figure 10.14, The extra carafe

Measurement system

The user should be encouraged to use the measurement system

This guideline aims to help the users to boil, brew or toast the wanted amount of water/coffee or toasting grade by encouraging use of the measurement system.

To work with this guideline, strive towards fulfilling the following statements:

- The measurement system should be easy to detect.
- The measurement system should be easy to use.
- The measurement system should focus on users different preferences.
- Adopt the measurement system to as many users as possible.

Examples

- The user should understand the consequences of boiling too much water.
- The configuration of the measurement system should correspond to what the users expects. For example what their mental model of a cup is.
- The placement of the measurement system should be prominent.
- The user should be encouraged to use more than the max/min limits on the measurement system.

On some kettles today the measurement system is placed behind the handle. By not placing the measurement system behind the handle it will be easier to detect and the chance of usage will increase. The use of transparent materials does also make the access of the measurement system easier from all angles (see figure 10.15).



Figure 10.15, Examples of the measurement placement

This is an example of a measurement system where focus is taken away from the max/min limits and instead the user is supposed to focus in the indication in between these. The measurement system uses the same indications as measurement systems does today to meet preferences of different users, some users prefers the indications to be in cups and some in decilitres. The picture also shows a comparison between the new measurement system and existing measurement systems with the aim to be more comprehensible.

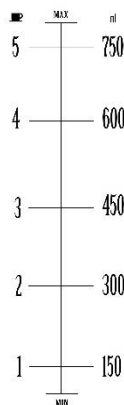

Figure 10.16, The measurement system

Explore alternative ways of designing the measurement system

This guideline aims to investigate other channels than the measurement system to encourage the user to boil only the amount of water or coffee needed.

To work with this guideline, strive towards fulfilling the following statements:

- The measurement system should raise the user's awareness about water consumption.
- The measurement system should motivate the user to boil the right amount of water.

Examples

- Restrict the user to measure the right amount of water.
- Investigate systems that help the user to measure the right amount of water.
- The measurement system should promote usage of more than the max and min limits.
- The product should give the user the possibility to adapt the system to own preferences.
- Use a complement to the product with similar goals as the measurement system.

In order to increase the use of the measurement system and for the users to use it in a way that reduces waste an example of configuration can be seen in figure 10.17. In this example the user can adapt the measurement system to own preferences by pre-installing the amount of water that they usually need and mark out their most frequently used amount of liquid on the measurement scale.



Figure 10.17, The magnet solution

The user should have an easy access to the measurement system

This guideline aims to work with the product and the measurement system to enable easy access for the users.

To work with this guideline, strive towards fulfilling the following statements:

- The measurement system should be easily assessable for the user.

Examples

- The measurement system should be visible for the user.
- The placement of the measurement system should be prominent.

Great focus has been on transparency to enable for the user to access the measurement system from all angles. The configuration of the handle does also make the access of the measurement system easier since it does not block it from any angle. See example in figure 10.18.



Figure 10.18, the handle, placing of measurement system and transparency

Use

How to interact with the product should be obvious

This guideline aims to work with the product's interaction features to make the user able to understand the product, and to use it in the intended and most efficient way.

To work with this guideline, strive towards fulfilling the following statements:

- Make the interaction with the product obvious.
- Make the users understand the product without difficulties.

Examples

- Make the symbols clear for the user.
- Use no or few buttons to decrease the risk of confusing the users
- Use no or few buttons to save resources.
- Placing and ordering of functions should be according to cognitive ergonomics to ease the use of the product.

The buttons are prominently placed on the product, this will make the interaction with the product easier for the users. Less buttons will decrease the possibility of users misunderstanding buttons and their function. Reducing the amount of functions and buttons will also decrease the amount of components and thereby materials can be saved. See example in figure 10.19.



Figure 10.19, Removed functions

The product should encourage to make use of extra coffee or water

This guideline aims to help the user to make use of the extra amount of coffee or water produced.

To work with this guideline, strive towards fulfilling the following statements:

- Make the user save the excess coffee or water.
- Make the user use the excess coffee or water for other things.
- Enable to keep the water or coffee warm
- Enable to transport the coffee or water in its warm state
- Not consuming more resources.

Examples

- Incorporate a thermos function.
- Incorporate an easy way for the user to bring the excess coffee or water from home

This idea is about incorporating a thermos function into the product that is also possible to take away. This extra function could either be incorporated into the actual product or come as an accessory. See example in figure 10.20.

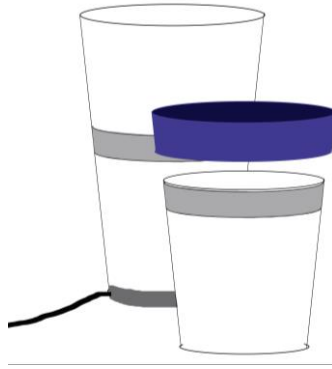

Figure 10.20, A thermos solution

The product should have a flexible interface

This guideline aims to help the user control the product and make it customized for each consumer without using more technology.

To work with this guideline, strive towards fulfilling the following statements:

- Make the product adaptable for many users.
- Make the product upgradeable.

Examples

- Give the user the possibility to adopt the functions of the products after desire.
- The product should give the user feedback at any time about the products status, such as if the product is on/off, if maintenance is needed, time left etc.
- The product should enable the user to control the products from a distance, for example start a timer or put the product on/off from a distance etc.
- The product should enable the user to get Eco-feedback, such as energy use (daily, weekly or per month).
- The users should have the possibility to choose which functions they need while still keeping the same base products.
- Design the product so that the user do not have to keep too much information about the product in their mind.

Using an app would not restrain the user to get the information only on the product, as a display would which would be in line with the desire of flexibility (see figure 10.21). Incorporating features into an app would create extra value for the users as well as increasing the chance of extending the product's life.

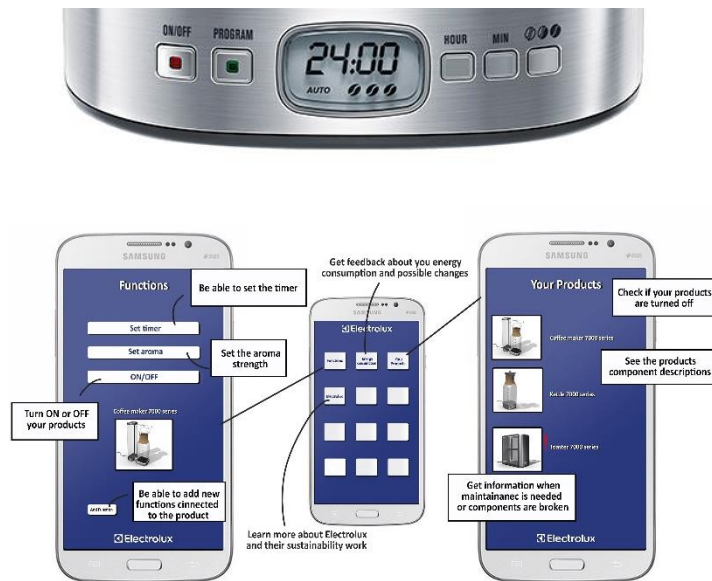

Figure 10.21, The current system and the app solution

Feedback

The product should give behavioural feedback

This guideline aims to give the user behavioural feedback to make them aware of how they act and how it affects sustainability.

To work with this guideline, strive towards fulfilling the following statements:

- Behavioural feedback should be provided through different channels.
- The product should raise the user's awareness about behavioural consequences.
- The feedback should be optional due to many different preferences amongst users.

Examples

- The product should motivate a regular use of the feedback to increase the chance of users adapting to it and use it in everyday life.
- The feedback should be provided over a longer period of time and preferably on a daily basis.

An example on how to apply this guideline to a concept is by giving the user's feedback through an app, see figure 10.22. The feedback would be optional since the users would have to consciously choose to download the app. This would enable for the feedback to be given over a longer period of time and every day but it would be up to the user to choose to take part of it or not.

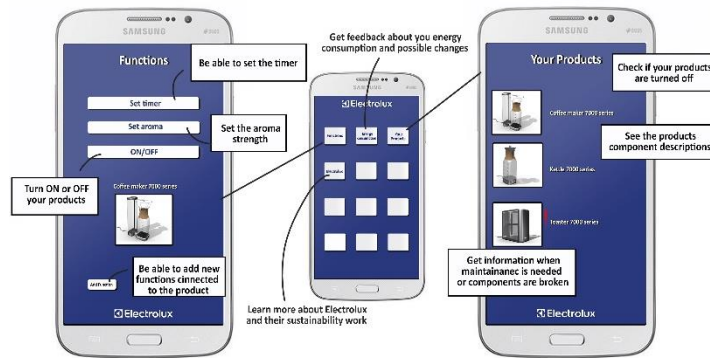

Figure 10.22, the app solution

Motivation

The product should motivate to a more sustainable everyday life

This guideline aims to bring sustainability into the user's everyday life to increase the acceptance of a new product that encourages a sustainable behaviour. The product should be used as a way to motivate people to act more sustainable. The product design should motivate the user to create new sustainable norms, attitudes and values.

To work with this guideline, strive towards fulfilling the following statements:

- The product design should help the user prioritize a sustainable behaviour.
- The product should be time efficient.
- The product should not interfere with existing lifestyles of the users.
- The products should not have a negative impact on the comfort of the user.
- The product should help the users to achieve their goals with the product without being a hinder.

Examples

- Design features of the product should help the user understand how to use it in a sustainable way.
- The user should be able to get information about sustainability.
- The user should be able to get information about a sustainable behaviour to increase awareness of their behaviours and possible changes.
- A sustainable behaviour should be an obvious choice, so that the users do not have to prioritize sustainability.
- Using the product should not take longer time than using existing products on the market.
- The product should give the user information about sustainable use in relation to the product.
- Design features of the product should make the user want to take care of the product.

An example of how this could be done is by providing the users with information via an app, see figure 10.23. Using this media, examples of changes and behaviours could be both provided and constantly updated.

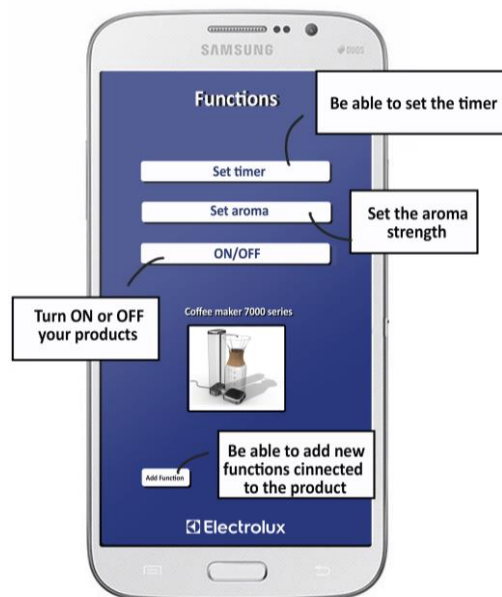

Figure 10.23, the app solution

The product should encourage to discussion about sustainability

This guideline aims to make the product express sustainability by its design to encourage sustainability discussions.

To work with this guideline, strive towards fulfilling the following statements:

- The product should be eye catching.
- The products should express sustainability features.
- It should be obvious that the product is sustainable.

Examples

- The choice of materials should be chosen to promote sustainability.
- The use of feedback systems should be used to raise awareness of the user's sustainable behaviour.
- The products should be eye catching when standing together as a collection.

Many users does perceive both wood and glass as sustainable materials and therefore the combination of these could with advantage be used to promote sustainability. See example in figure 10.24.



Figure 10.24, the handle in wood on the carafe

The product should motivate to maintenance

This guideline aims to design the product to help the user extend the product's life by keeping the product in a good condition.

To work with this guideline, strive towards fulfilling the following statements:

- Give feedback concerning cleaning and maintenance.
- The maintenance should increase the product lifetime.
- The product expression should encourage the user to handle the product carefully.

Examples

- Design the product so that it is easy to clean to increase the chance of maintenance.
- Designing the product so that it is cleaned in the right way, to decrease the risk of the product being worn out earlier than desired.
- The product should have the possibility of giving feedback to the users concerning cleaning and maintenance to increase the chance of users remembering to clean and maintain the product.
- Handling the product with care will decrease the risk of breaking the product.

Applying glass parts to the product is a way of enabling for the user to see that the product has been cleaned enough. It does also enable for the user to see when the product needs cleaning or maintenance.



Figure 10.25, glass parts of the coffee maker

If the product is equipped with an additional app reminders of maintenance and cleaning could be a part of its functions. This would help the user to remember to maintain but also make it easier for the user to check when their last maintenance took place. This would both create extra value for the users and extend the lifetime of the products.



Figure 10.26, Information and reminder of maintenance in the app solution

To encourage the users to handle the product with care glass has been incorporated. Most people know that glass can easily break and therefor glass parts can make them handle the product with more care. Creating extra value for the users is also a way of promoting careful handling since the user do care more about the products condition and want it to last longer.



Figure 10.27, The extra carafe

Durability

The product should be durable

This guideline aims to make products that lasts longer and therefore not become waste too fast. This guideline also aims to meet people's expectations of how long they expect their products to function.

To work with this guideline, strive towards fulfilling the following statements:

- The product should have a long lifetime.
- Make use of parts and components that are still functioning.
- Use materials that are durable.

Examples

- The product should have a lifetime of more than ten years.
- The product should be able to be repaired if broken.
- Identify which parts and components that break and optimize them to last longer.

The products should have a second hand value

This guideline aims to make the products last longer and give them a second hand value and to give them a second life.

To work with this guideline, strive towards fulfilling the following statements:

- The product should age well.
- Worn out components should be easy to replace.
- The product should have a long lifetime

Examples

- The product should age well, meaning that it does not get permanently dirty and consist of materials that get worn out quickly.
- Apply design for disassembly.

Energy consumption

The products should make use of spill energy

This guideline aims to make the product take advantage of energy losses.

To work with this guideline, strive towards fulfilling the following statements:

- Utilize energy losses to give power to other products.
- Reduce running costs for the products.

Examples

- Make the product take advantage of energy losses from different surrounding products.
- The products should share energy, since all the products transforms electrical energy into heat.

The display has been eliminated resulting in decreased energy consumption without the user making conscious choices. To move functions to an app solution would make the users use the products more sustainable.



Figure 10.28, Eliminated display

The products should minimize energy consumption

This guideline aims to optimize the performance of the products and raise awareness about energy consumption when the products is used and not used.

To work with this guideline, strive towards fulfilling the following statements:

- The product should be designed to help the users be energy efficient without extra effort.
- The product should be designed to raise awareness about energy consumption.

Example

- If making the energy consumption less in the product all users would be using a sustainable behaviour without having to make a conscious decision.

Displays makes the products consume more energy when on standby than they do without displays. Therefore, by eliminating the display the amount of energy that the products consume when on standby is reduced. In this example the functions of the display are incorporated in an app which also results in the elimination of both components and material.



Figure 10.28, Removed display and the app solution

End of life

The company should take responsibility for their products after end of life

This guideline aims to make the company aware of how their products works after the product is not used anymore.

To work with this guideline, strive towards fulfilling the following statements:

- Encourage more people to recycle their products.
- Understand how products age, break down and what the most common problems are.
- Take care of/be aware of worn out or broken products.
- Be aware of the critical parts of the products.

Examples

- The company should make use of their products after their end of life.
- The product should encourage more people to reuse products and give them a second life.
- The company could use different systems of making the users recycle their old products, such as discounts on returned products.
- The company should understand how their products age, break down and what the most common problems are to help them improve their products and make them more durable and sustainable.
- The company should strive to gain trust from the users by using a well worked out system for recycling.
- The company should take the opportunity to understand what does not work with their products.
- The company should take care of/be aware of worn out or broken products to make sure that they are recycled the right way or fixed and sold on a second hand market.

Disassembly

Design for disassembly should be applied

This guideline aims to design the product with focus on disassembly.

To work with this guideline, strive towards fulfilling the following statements:

- Make it easy to separate both materials and components.
- Make use of components that are still functioning.
- The product should be efficient to disassemble.

Examples

- Make use of components that are not worn out to give them a second life and reduce unnecessary waste.
- Make the product simple to disassemble to make it easy to repair if broken. This could increase the lifetime of the product and also reduce unnecessary waste.

This guideline could be applied to a product by developing a system where worn out or old products comes back to the company. The best way to apply this guideline is for the company to take responsibility for their old products and to take responsibility for their recycling and second life. The company could benefit from the information provided from used or worn out products to gain knowledge about future design changes to improve the products.

To express sustainability without greenwashing can be seen in the picture 10.30. Features used in this example are rounded corners, the use of materials that are perceived as sustainable and simplistic forms. Specific examples of how to incorporate these features are the visible pipe, the transparency of the water container and the hole in the bottom of the container these gives the product an honest expression perceived as sustainable. Honest expressions can be captured by enabling for the user to see the inside and the functions of the product.



Figure 10.30, examples of the concept

In the picture above are examples of stereotypical sustainability features that are perceived as Green washing. These features should be used in an as small extent as possible in the product design.



Figure 10.31, Examples of green washing

- Symbols such as trees and leafs printed on packaging and products.
- Green elements on details, printings and components.
- Green labels on the products and packages.
- Plants when exhibition

The products should not become waste to fast

This guideline aims to make product life-span longer and decrease the risk of becoming waste to fast. This guideline also aims to make the product's lifecycle more sustainable.

To work with this guideline, strive towards fulfilling the following statements:

- The product should be durable.
- The products should be upgradeable.
- The products should be serviceable.
- The products should be repairable.
- The products should be reusable.
- The products should be recyclable.
- The product should be modular.

Examples

- The product should be durable by means of good materials and good manufacturing.
- The products should be recyclable to make it possible to reuse the materials in the products.
- The product should be easy to repair and disassemble.
- The design should focus on aesthetic durability.
- Reduce the amount of different parts and components.
- The products should be designed to support the whole product's life cycle.

The product should create extra value

This guideline aims to create extra value for the user and the company when owning the product.

To work with this guideline, strive towards fulfilling the following statements:

- Create value for the users
- Understand the needs of the user

Examples

- Investigate what extra value is for the intended target group.
- The products should create value for the user by not only serving as the original use.
- The product can use an alternative shape to challenge stereotypes of what the product looks like to make the user more interested and curious about the product.
- Saving material by reducing, or completely eliminate, components such as buttons and wheels for interacting with the products.
- Use new technology to remind the users when to maintain their products and how to do it in order to make the products last longer.
- The users could benefit from always being able to see if their products are turned on or off and even be able to turn them on/off from a distance.
- The products should use new technology to communicate with the users to be able to give them eco-feedback.

- The user should be able to see and/or understand how the products functions without difficulties.
- The product should only do what it is aimed for and not be given any extra unnecessary functionalities.
- Use new technology to make it possible to upgrade and change function after purchase.
- Use new technology to make able to track their users and their habits around the products

An example of how extra value can be created is by enabling for the product to function in different contexts. The carafe shape of both coffee maker and kettle is an example of this. The carafe can be used for both hot and cold water for example on a dinner table. This is also good from a compact living perspective where people would need less amount of products if they are multifunctional. The carafe shape of the kettle is also an example of how stereotypes can be challenged. One of the more prominent features of kettles today is the big handles. Therefore incorporating the handle in the neck of the carafe challenges people's perception of what a kettle is supposed to look like and arouses feelings of curiosity and interest. The carafe shape of the kettle is an example of how stereotypes can be challenged. One of the more prominent features of kettles today is the big handles. Therefore incorporating the handle in the neck of the carafe challenges people's perception of what a kettle is supposed to look like and arouses feelings of curiosity and interest.



Figure 10.32, The carafe

If the user wants to place all three products together a problem could be how to connect all three products at the same time. Standard kitchens usually have two inlets in relation to countertops. A possible way of solving this can be seen in the picture above. The idea is that the products are bought without cords and the user gets to choose before purchase what cord solutions they are interested in. The products could have separate cords, one cord for all three or one cord for two products and one separate. The cord solutions should be possible to change between the products, resembling of how computer cords are plugged in the computer today.



Figure 10.33, The cord solution

The product should consist of sustainable materials

This guideline aims to design products that are sustainable in the material choices.

To work with this guideline, strive towards fulfilling the following statements:

- The materials that the product consist of should be advantageously reusable.
- The materials that the product consist of should be durable.
- The materials that the product consist of should be advantageously recyclable.
- The materials that the product consist of should not contribute to unnecessary emissions in any steps of the product life cycle.

10.2.3 Compact living

These guidelines aims to make Compact living a part of the company's product expressions.

The products should be optimized

This guideline aims to optimize the product and take advantage of the user's lifestyle and behaviours when designing the products. This guideline also aims to design the products without any unnecessary material, technology or functions to make the product have a minimalistic design for a sustainable expression.

To work with this guideline, strive towards fulfilling the following statements:

- The products should take up less space when on display.
- The products should take up less space when stored.
- The product should be easy to move.
- Optimize material use.
- Optimize manufacturing.
- Optimize energy consumption

Examples

- The products should be smaller to improve compact living and decrease material use.
- The products should benefit from each other's forms when standing close to each other in order to be space effective.
- The products could be combined into one but still function separately.
- The product should consist of as few components as possible.
- The product should only use the functions needed.
- The amount of electronics in the product should be decreased.
- The product should promote a simple manufacturing.
- No extra or unnecessary material should be used.
- The product form should use minimalistic features.
- The products should only use the amount of energy needed.
- Unnecessary heating of the product should be eliminated to save resources.

An example of how to make the collection of products take up less space is by shaping them to benefit from each other's form. If the products are designed so that they can stand closer to each other.



Figure 10.34 The concept collection in relation to the reference collection

How to apply minimalistic design features to a product can be seen in the figure 10.35.



Figure 10.35, Handles

The products should be easy to store

This guideline aims to make the products easy to store when on display, in cabinets or drawers. When it comes to design the products should also be adjusted to small kitchens.

To work with this guideline, strive towards fulfilling the following statements:

- The product should fit into standard sized cabinets and/or drawers.
- The product itself should be designed to be movable.
- The products should not take up unnecessary space.

Example

- The cord should not make the products harder to store.

An example of products with reduced size, taking advantage of each other forms to take up less space when standing together can be seen in the picture 10.36. The reduced size will make the products easy to store and easier to move.



Figure 10.36, The collection

10.3 Evaluation

An evaluation of the products in the example collection was made to investigate whether the intended expression were captured or not. Six design students participated in the evaluation. The evaluation started with a new trend analysis where the participants were asked to place the products on a graph going from conservative to innovative and from unsustainable to sustainable as in the first trend analysis from the pre-study. The participants were also asked to fill in a Geneva emotion wheel and a Semantic word scale for the developed products, see Appendix V and VI. The results from the evaluation will be presented below.

10.3.1 Trend analysis

According to the new trend analysis the collection does end up in the identified gap of sustainable and innovative products as can be seen in figure 10.37. The coffee maker and the kettle were the products that were rated the highest on both sustainability and innovativeness. The toaster in comparison to the other products were experienced as less innovative and sustainable. The participants explained that they experienced the transparent sides as a reason for great heat losses and therefore less sustainable. The products did also feel complicated and the low grade on innovativeness was due to that the toaster resembled a classical toaster more than the other products did resemble their references.

The coffee maker got a high ranking on innovativeness because it did not resemble anything that the participants had seen before. Materials and expression was what made the participants experience the coffee maker as sustainable. The kettle felt innovative because it expressed minimalism and the new expression did not derive from the old expression of a water boiler on the stove as most kettles do today. As for the coffee maker materials and expression was what made the participants experience the kettle as sustainable. One participant did place the collection lower on sustainability than the other participants due to the interpretation of luxury. For this participant luxury was an expression that did not correspond to sustainability.

In table 10.1-10.4 below are comments from the participants during the evaluation summarized.



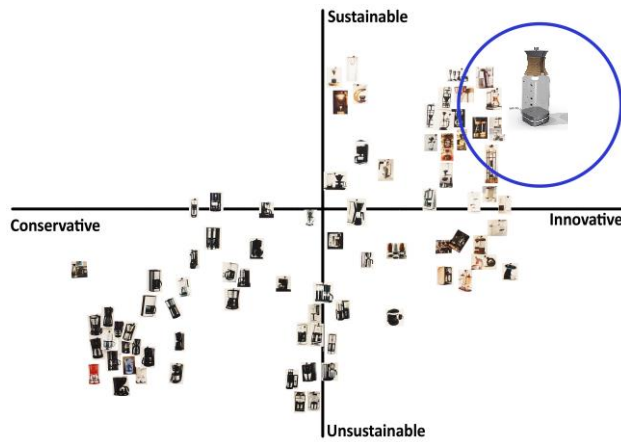
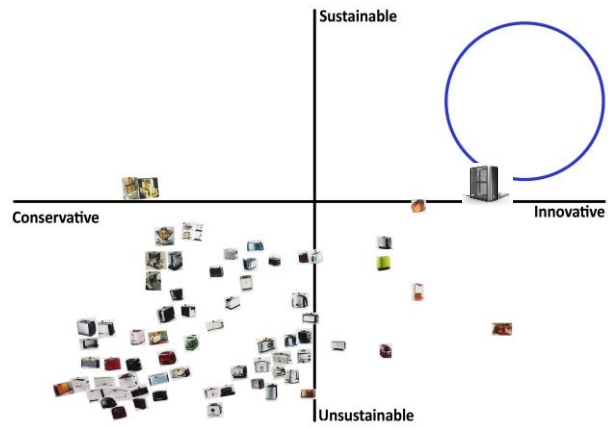

Figure 10.37, New trend analysis

<p>Coffee maker</p>	<p><i>“Feels sustainable because of its minimalistic expression, honesty, does what it is supposed to.”</i></p>
	<p><i>“Feels more complex than the kettle but also more innovative because it feels cool. Never seen something like this before.”</i></p> <p><i>“Same innovation level as the kettle, maybe even higher. Have a sustainable expression but not as much as the kettle because it does not feel as simple in relation to the kettle.”</i></p> <p><i>“Glass feels sustainable, good that you can see the functions.”</i></p> <p><i>“Looks different and economical with materials. Fun that it is a classical brewing coffee maker.”</i></p>

Table 10.1, Comments from trend analysis, coffee maker

Kettle	
	<p><i>“Feels the most innovative because it is only what it is, the expression is new compared to existing kettles. Feels less plastic and more elegant.”</i></p> <p><i>“Feel sustainable because of less electronics and stuff.”</i></p> <p><i>“Looks the most sustainable out of the three. Gives a feeling of being technically advanced, good energy efficiency. Innovative because of new form, otherwise kettles derives from old expressions.”</i></p> <p><i>“Feels new and sustainable with the transparent glass parts. Does not hide anything.”</i></p> <p><i>“New and fun design, looks like a water carafe. Few materials.”</i></p>

Table 10.2, Comments from trend analysis, kettle

Toaster	
	<p><i>“The least sustainable expression of the three because it feels like a lot of heat will be lost using the glass walls, gives an aggressive expression.”</i></p> <p><i>“Feels more complicated than the other products but innovative and cool. Never seen something like this before.”</i></p> <p><i>“The toaster have an inherited expression of not being sustainable because of the heating elements. This toaster feels simplistic with few components and the transparency, that you can see the breads. The transparency makes you not burn as much and not trough as much bread away. This toaster does not look as an ordinary toaster but does still have the generically expression of a toaster.”</i></p> <p><i>“You can see that the heating elements transports electricity.”</i></p> <p><i>“Looks like an ordinary toaster except for the transparent glass parts. Nice to be able to see the bread so that you do not toast too much.”</i></p>

Table 10.3, Comments from trend analysis, toaster

The collection	
	<p><i>“They feel innovative in that they are simple and futuristic, good-looking. The simplistic expression does promote sustainability but the reason that I did place them so low on sustainability is because they feel exclusive. Consist of exclusive materials and the manufacturing feels complex to achieve this expression. I could place them higher up on sustainability, it is a contradiction within me because I do believe that exclusive can still be sustainable but I choose to keep them like this.”</i></p>

Table 10.4, Comments from trend analysis, the collection

10.3.2 Geneva emotion wheel

In this part the Geneva emotion wheel from the evaluation will be presented as well as the Geneva emotion wheel from the usability tests described in the pre-study. When comparing these it is important to remember that the emotion wheel in the usability tests were filled in after the users had interacted with the products. In the evaluation the participants filled in the emotion wheel only based on the products appearance.

Coffee maker

When comparing the results from the emotion wheels the concept coffee maker got in general higher rankings on the positive emotions and lower rankings on the negative emotions than the reference coffee maker. The feeling of involvement and interest for the concept coffee maker got the second highest score compared to the second lowest for the reference coffee maker. The only negative emotion where the concept coffee maker got the same score as the reference coffee maker was worry/fear. The emotion got the second lowest score, but should still be focused on to be eliminated. All results from the two emotion wheels can be seen in Appendix V.

Kettle

The concept kettle is the only product out of the three that got a higher ranking on a negative feeling compared to the reference kettle. The feeling that got a higher negative ranking was the feeling of worry/fear. Therefore this feeling has to be further investigated in order to be eliminated. All positive emotions got a higher or equal ranking when comparing the results between the concept kettle and the reference kettle. The feeling of enjoyment/pleasure and astonishment/surprise were the feelings who got an equal ranking. All results from the two emotion wheels can be seen in Appendix V.

Toaster

As the other two products the concept toaster got in general higher scores on the positive emotions and lower on the negative emotions when compared to the reference toaster, with some exceptions. The negative emotion that got an equal ranking between the two products was the feeling of worry/fear and the positive emotions that got an equal ranking were the feelings of enjoyment/pleasure and happiness/joy. All results from the two emotion wheels can be seen in Appendix V.

Comments

A possible affecting factor is that the participants in the evaluation did not get to interact with and use the products. Further tests with prototypes has to be made in order to strengthen the results and to investigate if new parameters appears.

Two of the participants explained their high score on the negative emotion of worry/fear with the fear of burning their fingers because of the glass. This was something that was discussed during development of the carafe and the carafe does for example have a groove in the handle on the kettle and coffee maker to eliminate the risk of burning. The nozzle and the length of the handle are also parameters that were thought to eliminate the risk of evoking this feeling. The toaster has a frame of stainless steel that also was identified as minimizing the risk of burning. There is a possibility that the users might experience other emotions if interacting with the actual products and that these are parameters that they do not experience by only looking at the products. This also motivates tests with prototypes to investigate these emotions further.

The feeling of surprise was interpreted as positive since it gave an indication of that the concept product did challenge stereotypes of the products expression.

10.3.3 Semantic word scale

In this part the Semantic word scale from the evaluation will be presented as well as the Semantic word scale from the usability tests described in the pre-study. When comparing these it is important to remember that the Semantic word scale in the usability tests were filled in after the users had interacted with the products. In the evaluation the participants filled in the Semantic word scale only based on the products appearance. The semantic word scales in the two tests are neither completely the same.

Coffee maker

According to the semantic word scale the concept coffee maker was perceived as *simplistic*, *good looking*, *space effective* and *inspiring*. The result also indicates that most participants experienced the product as *sustainable* and *minimalistic*. These were all targeted features. The perceived features from the reference coffee maker did not show any strong results. The reference coffee maker was perceived as irritating a feature that has been eliminated in the new evaluation. All results from the semantic word scales can be found in Appendix VI.

Kettle

According to the semantic word scale the concept kettle was perceived as *simplistic*, *space effective* and *inspiring*. The result also indicates that most participants experienced the product as *sustainable* and *minimalistic*. These were all targeted features. The perceived features from the reference kettle did not show any strong results. All results from the semantic word scales can be found in Appendix VI.

Toaster

The results from the semantic word scale gives indications that the concept toaster was perceived as *simplistic*, *good looking*, *space effective* and *inspiring* by most participants. Compared to the reference toaster that was neither perceived as *good looking* nor *space effective* this result indicates that some improvements has been made. Features that were not communicated as intended in the concept toaster was *sustainability* and *minimalism* which got

neutral rankings in the evaluation. All results from the semantic word scales can be found in Appendix VI.

Comments

After the result from the evaluation and discussions with supervisors from Electrolux the toaster was re-designed. The toaster that is presented in this report has got a slightly smaller frame around the glass part and smaller radiuses in the bottom than in the top compared to the toaster on which the evaluation was made. This was a way of improving the *sustainability* and *minimalistic* features of the toaster but further investigation will have to be done in order to see if the new design achieves this.

Both coffee maker and kettle did express the features that was intended. To further strengthen these results investigations with prototypes will have to be done.

11. Final discussion

An interesting matter that have been raised during the project is the question of how the design could have been affected through a more drastically change that still is positively experienced and that do not affect the user negatively and decrease the comfort of the user. A more deep analysis of how this could have been made would have been interesting to analyse concerning design techniques and technology on the market combined with new future technology. New technology might affect the adaptiveness of more drastically changes, and a hypothesis is that if this would be integrated into the product a new way of making coffee, hot water and toasting bread could be more challenged in a more acceptable way.

A concept that was discussed a lot was Concept four where the users could pre install their measurement settings themselves. This concept challenges the measurement systems in a way that the other concepts did not. The concept removes the possibility to measure the water in the wrong way by being adaptable after every specific user and its preferences. Why this product was excluded when choosing a final concept was due to that it is a combo product. A combo product can be negatively experienced by the user since the product might get more expensive both for the company and the users and the users are often not prepared to pay more for a combo product. This would also be negative in a sustainability point of view if a component breaks two products needs to be replaced instead of only one.

This project have analysed the field of Design for Sustainable Behaviour and how this can be applied on small household appliances. When analysing the field of DfSB a lot of guidelines were found that could be applied to products. Mostly concerning feedback and the measurement systems. But what was also found was that the habits and routines around these products are very hardly printed into the users and this makes the applicability of the guidelines more difficult. It has been seen that the lifestyles and the routines and an easy use of the products is more valuable than the sustainability aspect combined with a product that challenges the routines too much. This made it difficult to apply the guidelines to create a concept that challenges the stereotypes of exists products. To apply these guidelines in a more advantageous way more demands from the user about their thinking around these products are needed to increase the possibility of acceptance. The product had a lot of negative design features and design aspect when analysing the products but the routines amongst users were so strong that they did not experience negative feelings towards existing products and routines.

In relation to the guidelines developed within the field of DfSB the guidelines about compact living felt easier to apply to the product series. Why this is has been a constant subject of discussion during the project and a proposal is that this area is more profitable for the users. The benefits with buying a product that promotes compact living are easier for the user to perceive only by looking at the product whilst benefits with products that promotes a more sustainable behaviour must be interpreted using more than product appearance. The positive effects that accompanies a compact living product are more immediate, for example they take up less space, which is something that the users can perceive instantly. The positive effects of a DfSB product is more complex. These features are something that the user might never take notice of because they affect the user in an unconscious way. In the best of cases the users adopt the sustainable behaviour without conscious decisions, because the sustainable behaviour is the obvious behaviour, then the products has succeeded in its intention. It is therefore hard to say if the DfSB guidelines has been applied in a desired way whilst the compact living guidelines

are easier to evaluate. A way for the company to sell more sustainable product should therefore be by combining these two areas. This would increase the possibility of more users perceiving the benefits of the products.

The range of people that see sustainability as the most important factor when choosing products are still small, for most people price is the most important factor. So for sustainability to be prioritised more value has to be integrated for the users who choose to buy sustainable products. A beneficial parameter is that the trends are changing and the sustainability awareness is increasing amongst users and sustainability questions on its own is becoming more valuable for customers.

The toaster is designed to follow the other products in the collection and therefore most functions has been moved to be controlled through the application. The application is thought to give the users extra values but can have a negative effect on users that do not have or use a mobile regularly or in their morning routines. It might also be negatively experienced for users that are not interested in using their phones in relation the kitchen ware products or the users that do not understand how it is supposed to work. For the other two products in the collection, the coffee maker and the kettle, it is still possible for the user to use their basic functions without the application. But as the grading wheel on the toaster has been moved to be controlled through the application this is no longer the case with the toaster. This could affect the sustainability point of view in a negative way since people would not get the toasting that they want and more bread might be wasted. A consequence of this could also be a negative experience for the users which would not be beneficial for the company either. The toaster in the concept series does only have one slot for bread instead of two which was found to be what most of the users wanted. The decision to move away from the desires of the users was based on benchmarking. If Electrolux want to compete with the WMF mini-series this is one way for them to go. To create a product series that is completely in line with the area of compact living this is advantageous. The kettle is the products that is challenging stereotypes the most amongst the products in the concept series. The kettle does move away from some of the Electrolux design features found in the DFA. For example the handle is now reshaped and removed to win space and is made out of one material which results in that the handle is no longer divided into two parts by a split line or a material change. The size of the pipe is also changed, it is now less defined but serves more like a way of giving the product a direction and as a safety feature for the users to not get hot water on their fingers. Most kettles today are cylinder-, egg- or cone shaped which the concept design does challenge by using a square shape to gain compact living and more easy storage. The function button of the lid is usually on or close to the handle but in this concept it is placed as a separate part of the products and placed inside the opening.

Green branding is a way of expressing sustainability features in a products without using features of greenwashing such as the colour green and leaves. All companies included in the benchmarking of this project did use green washing features in some ways. One possible explanation for this is that companies are still not aware of the terms greenwashing and green branding or has still not implemented it in their work. Another possible reason why they use these features is because it is the fastest and easiest way. It is well implemented amongst people that the colour green and leaves, globes etc. does stand for sustainability. Moving away from these features requires extra work and a user awareness that companies might not value that high. As sustainability becomes more of a prerequisite rather than an option a shift away from greenwashing and towards green branding is a good hypothesis about future product expressions.

12. Final conclusion

The behaviour that was identified as the most critical in the use of the breakfast collection was behaviours around the measurement systems. It is also of great importance to not affect the comfort or routines of the users in a negative way when trying to implement a new product. As can be seen in the booklet the guidelines developed within the field of DfSB were possible to apply on a product series. This result is an example of how guidelines within the field of DfSB can be applied to a collection of coffee maker, kettle and toaster, answering the first research question of the project: *How can guidelines within the field of Design for Sustainable Behaviour be applied to a collection of coffee maker, kettle and toaster?*. Since behaviours appear in the very moment that a user interacts with a product no conclusion can be drawn whether or not behaviour will change in relation to the example collection. In order to test this prototypes of functioning product would have to be evaluated. The guidelines are a good way to start working with creating sustainable behaviours but would have to be further evaluated.

Working with green branding the importance of implementing sustainability features in products were identified but also the importance of avoiding features perceived as greenwashing. The developed concept shows an example of how to apply the guidelines within green branding on a product series. Evaluations show that the intended expressions of sustainability were reached and therefore the concept is a valid example of how guidelines within the field of green branding can be applied to a breakfast collection answering the question: *How can guidelines within the field of Green branding be applied to a collection of coffee maker, kettle and toaster?*.

The guidelines within the field of compact living puts great focus on reduction of size, how storable and movable the products are and importance that they take up as little space as possible both as individual product but also when standing together as a collection. Since the final concept example focuses on all these it is a way of exemplifying how guidelines within the field of compact living can be applied to a coffee maker, kettle and toaster therefore answering the question: *How can guidelines within the field of Compact living be applied to a collection of coffee maker, kettle and toaster?*

Some product on the market today were identified as encouraging a sustainable behaviour to some extent. But no products were found that completely fulfils all guidelines developed during the project. A conclusion can therefore be drawn that there is still a lot of work left to do before product on the market today can be completely classified as encouraging a sustainable behaviour. Products do exist where the work towards a more sustainable behaviour has been implemented but not as much as is possible. It is therefore hard to give a clear answer to the research question: *Are there any coffee makers, kettles or toaster on the market today that encourages a sustainable behaviour?* Because the answer is yes, but a vague yes where there is still a lot left that could be done within this field.

A future recommendation for the company is to try and launch a sustainable collection within small household appliances. A way to start work within this field would be to apply the guidelines created during this project in the product development process. There is a need for a sustainable breakfast collection on the market as soon as possible. Many companies has already started to launch sustainable products within this field. Sustainability will soon be something people take for granted and therefore it is desired to be in the forefront to work proactive rather than reactive to take place on the market.

13. References

Tracy Bhamra, Debra Lilley & Tang Tang (2011) *Design for Sustainable Behaviour: Using Products to Change Consumer Behaviour*, The Design Journal, 14:4, 427-445, (Bhamra et al. 2011)

Braun (2016) *Sustainability*, Retrieved (2016-02-10) from <http://www.braun.com/global/world-of-braun/sustainability.html> (Braun 2016 *Sustainability*)

Braun (2016) *Sustainability- Sustainability Through Our Products*, Retrieved (2016-02-10) from <http://www.braun.com/global/world-of-braun/sustainability/sustainability-through-our-products.html> (Braun 2016, *Sustainability- Sustainability Through Our Products*)

Broadroast (2016) *Brödrost*, Retrieved (2016-05-26) from <http://broadroast.weebly.com/brouldrost.html> (*Broadroast* 2016)

Crazy builders (2016) *How it works: Coffee maker*, Retrieved (2016-03-15) from: <http://www.crazybuilders.com/> and <https://www.youtube.com/watch?v=COKlObhGt50> (Crazy builders 2016)

Danicu, V. (2015) *Successful Green Branding, a New Shift in Brand Strategy: Why and how it works*, The Romanian economic journal, no. 56, p.47-64, Bucharest University of technology (Danicu, 2015)

Richard Dobbs, Jaana Remes, James Manyika, Charles Roxburgh, Sven Smit & Fabian Schaar (2012), *Urban world: Cities and the rise of the consuming class*, Report, McKinsey Global Institute, June 2012, Retrieved (2016-05-26) from <http://www.mckinsey.com/global-themes/urbanization/urban-world-cities-and-the-rise-of-the-consuming-class> (Dobbs et al. 2012)

El-kretsen (2016) *Vinnande återvinning*, Retrieved (2016-05-21) from http://www.elkretsen.se/sitespecific/elkretsen/files/producentansvar/diverse_elektronik_faktablad.pdf (El-kretsen 2016)

Electrolux (2016), *Annual report 2014 - Our Values*, Retrieved (2016-04-07) from <http://annualreports.electrolux.com/2014/en/strategic-development/our-values/> (Electrolux 2016a)

Electrolux (2016) *Sustainability- The way we work*, Retrieved (2016-01-26) from <http://www.electroluxgroup.com/en/category/sustainability/the-way-we-work/> (Electrolux 2016b)

Electrolux (2016) *Electrolux annual report 2014*, AB Electrolux (publ), 556009-4178, Retrieved (2016-04-07) from <http://www.electroluxgroup.com/en/wp-content/uploads/sites/2/2015/02/Electrolux-Annual-Report-2014.pdf> (Electrolux 2016c)

Electrolux (2016) *Brands*, Retrieved (2016-04-07) from <http://www.electroluxgroup.com/en/category/about/brands/> (Electrolux 2016d)

Electrolux (2016) *Electrolux markets*, Retrieved (2016-04-07) from <http://www.electroluxgroup.com/en/electrolux-markets-16563/> (Electrolux 2016e)

Electrolux (2016) *Sustainable design*, Retrieved (2016-04-07) from <http://www.electrolux.com.au/Innovation/Inside/Innovation-News-Articles/From-Insight-to-Innovation/AeroPro-Innovation-news1/?topic=94>. (Electrolux 2016f)

Electrolux (2016) *Sustainability Matters 2013*, AB Electrolux (publ), Retrieved (2016-04-07) from <http://www.onestoneadvisors.com/images/docs/Electrolux-Sustainability-Matters-2013.pdf> (Electrolux 2016g)

Electrolux (2016) *Materials*, Retrieved (2016-01-26) from <http://www.electroluxgroup.com/en/materials-1003/> (Electrolux 2016h)

Electrolux (2016) *Energy Efficient Labeling Retrieved* (2016-01-26) from <http://www.electroluxgroup.com/en/energy-efficiency-labeling-1033/> (Electrolux 2016i)

Electrolux (2016) *Electrolux in brief*, Retrieved (2016-04-07) from <http://www.electroluxgroup.com/en/electrolux-in-brief-492/> (Electrolux 2016j)

Electrolux (2016) *Kaffebryggare EKF7500*, Retrieved (2016-05-16) from <http://www.electrolux.se/kitchen/small-kitchen-appliances/coffee-makers/coffee-maker/ekf7500/> (Electrolux 2016k)

Electrolux (2016) *Produktinformation EKF7500 PDF*, Retrieved (2016-05-16) from <http://www.electrolux.se/kitchen/small-kitchen-appliances/coffee-makers/coffee-maker/ekf7500/> (Electrolux 2016l)

Electrolux (2016) *Vattenkokare EEWA7500*, Retrieved (2016-05-16) from <http://www.electrolux.se/kitchen/small-kitchen-appliances/kettles-water-filters/kettle/eewa7500/> (Electrolux 2016m)

Electrolux (2016) *Produktinformation EEWA7500 PDF*, Retrieved (2016-05-16) from <http://www.electrolux.se/kitchen/small-kitchen-appliances/coffee-makers/coffee-maker/ekf7500/> (Electrolux 2016n)

Electrolux (2016) *Brödrost EAT7100*, Retrieved (2016-05-16) from <http://www.electrolux.se/kitchen/small-kitchen-appliances/toasters/toaster/eat7100/> (Electrolux 2016o)

Electrolux (2016) *Produktinformation EAT7100 PDF*, Retrieved (2016-05-16) from <http://www.electrolux.se/kitchen/small-kitchen-appliances/coffee-makers/coffee-maker/ekf7500/> (Electrolux 2016p)

Elektronikåtervinning (2016) Retrieved (2016-04-04) from <http://elektronikatervinning.com/privatperson/> (Elektronikåtervinning 2016)

Corinna Fischer (2008) *Feedback on household electricity consumption: a tool for saving energy*, Energy Efficiency (2008) 1:79–104 DOI 10.1007/s12053-008-9009-7, (Fischer, 2008)

Greenwashing index (2016) *About greenwashing*, Retrieved (2016-05-26) from <http://greenwashingindex.com/about-greenwashing/> (*Greenwashing index* 2016)

The Guardian (2016), *Which is more energy efficient - boiling water using an electric kettle, a kettle on a gas hob or a microwave oven?* Retrieved (2016-03-17) from <http://www.theguardian.com/notesandqueries/query/0,5753,-2452,00.html> (The Guardian 2016)

How things work (2016) *How does a toaster or hairdryer work?* Retrieved (2016-03-15) from http://www.energyquest.ca.gov/how_it_works/toaster.html (How things work 2016)

Johannesson, H., Persson, J-G. & Pettersson, D. (2004) *Produktutveckling- effektiva metoder för konstruktion och design*, Edition 1, Liber AB, Stockholm, Bulls House of Graphics 2004. (Johannesson et al. 2004)

Karjalainen, T-M., Heiniö, S & Rahe, U (2010). *Visual Recognition Wrapped: Student Explorations of Product Packages as Brand Messengers*. 11th International Conference on Engineering and Product Design Education. Trondheim, Norway, September 2-3, 2010. (Karjalainen, Heiniö & Rahe 2010)

Karjalainen, T., Nikitas, A. & Rahe, U (2013). *Strategic Design through Brand Contextualization*, 5th International Congress of International Association of Societies Of Design Research, Japanese Society for the Science of Design. Tokyo, Japan (Karjalainen, Nikitas & Rahe, 2013)

Karlsson, MariAnne (2007) *Brukarkarakterer & Lyssna till kundens röst*, Appendix till kurskompendium. Chalmers Tekniska Högskola, inst. för Produkt- och produktionsutveckling, avd. Design, 2008. (Karlsson 2007)

Karin Lidman & Sara Renström (2011) *How to design for sustainable behaviour - A Review of Design Strategies & an Empirical Study of Four Product Concepts*, Master of Science Thesis in the Master Degree Programme Industrial Design Engineering, Department of Product & Production Development, Division of Design & Human Factors, Chalmers University of Technology, Göteborg, Sweden, 2011, (Lidman & Renström 2011)

Per Nilsen, Michael Bourne & Bas Verplanken (2008) *Accounting for the role of habit in behavioural strategies for injury prevention*, International Journal of Injury Control and Safety Promotion, 15:1, 33-40, DOI: 10.1080/17457300701794253, (Nilsen et al. 2008)

OBH Nordica (2016) *Our Policy for Sustainable Development*, Retrieved (2016-02-10) from <https://www.obhnordica.com/about-obh-nordica/sustainable-development> (OBH Nordica 2016, *Our Policy for Sustainable Development*)

Person, O., Karjalainen, T., Rahe, U. (2008) *Teaching strategic product styling: an educational approach to the use of consumer data in designing brand recognition*, Helsinki School of Economics, p.1-6 (Person, Karjalainen & Rahe, 2008)

Philips (2016) *Lighting blog*, Retrieved (2016-05-24) from <http://applications.nam.lighting.philips.com/blog/index.php/2013/02/12/philips-lighting-environmental-award/> (Philips 2016a)

Philips (2016) *Sustainability*, Retrieved (2016-02-10) from <http://www.usa.philips.com/a-w/about-philips/sustainability.html> (Philips 2016b)

Philips (2016) *Sustainability- Sustainable planet*, Retrieved (2016-02-10) from <http://www.philips.com/a-w/about/sustainability/sustainable-planet.html> (Philips 2016c)

Sara Renström & Ulrike Rahe (2013) *Pleasurable Ways of Staying Warm – A Pathway towards Reduced Energy Consumption*, Proceedings from the IASDR Conference 2013, Consilience and Innovation in Design, 24-30 August 2013, Tokyo, s. 1783-1794 p. 1783-1794. (2013), (Renström & Rahe 2013)

Ryan & Hakan (2016) Engineers at Electrolux, oral reference by e-mail (2016-03-04) (Ryan & Hakan 2016, oral)

Sarkar, A.N. (2012) *Green Branding and Eco-innovations for Evolving a Sustainable Green Marketing Strategy*, Asia-Pacific Journal of Management Research and Innovation, Sage Publication 8(1) p. 39–58 (Sarkar, 2012)

Anneli Selvefors, Karin Blindh Pedersen & Ulrike Rahe (2011) *Design for Sustainable Consumption Behaviour - Systematising the use of Behavioural Intervention Strategies*, DPPI'11 Proceedings of the 2011 Conference on Designing Pleasurable Products and Interfaces, Article No.3, (Selvefors et al. 2011)

Anneli Selvefors, I. C. MariAnne Karlsson & Ulrike Rahe (2013) *What's in it for the user- Effects and perceived user benefits*, Proceedings of the ERSCP-EMSU 2013 conference, 16th Conference of the European Roundtable on Sustainable Consumption and Production (ERSCP) & 7th Conference of the Environmental Management for Sustainable Universities (EMSU), 4 – 7 June 2013, Istanbul, Turkey. p. 1-14. (2013), (Selvefors et al. 2013a)

Anneli Selvefors, I. C. MariAnne Karlsson & Ulrike Rahe (2013) *What's in it for the user? Effects and perceived user benefits of online interactive energy feedback.*, Proceedings of the ERSCP-EMSU 2013 conference, 16th Conference of the European Roundtable on Sustainable Consumption and Production (ERSCP) & 7th Conference of the Environmental Management for Sustainable Universities (EMSU), 4 – 7 June 2013, Istanbul, Turkey. p. 1-14. (2013), (Selvefors et al. 2013b)

Anneli Selvefors (2014) *Understanding energy behavior, a necessity for supporting domestic energy conservation through design*, Thesis for the degree of licentiate of engineering, Department of Product and Production Development, Chalmers University of Technology, Division Design & Human Factors, Gothenburg, Sweden (2014), (Selvefors, 2014)

Anneli Selvefors, I. C. MariAnne Karlsson & Ulrike Rahe (2015) *Conflicts in Everyday Life: The Influence of Competing Goals on Domestic Energy Conservation*, Department of Product and Production Development, Division Design & Human Factors, Chalmers University of Technology, SE-41296 Gothenburg, Sweden (Selvefors et al. 2015)

Anneli Selvefors, Helena Strömberg & Sara Renström (2016) *What a designer can change: a proposal for a categorisation of artefact-related aspects*, 2016 Design Research Society, 50th Anniversary Conference, 26-30 June 2016, Brighton, UK, (Selvefors et al. 2016)

Stompff, G. (2003) *The forgotten bond: Brand identity and product design*, Design management journal, winter 2003, p.26-32 (Stompff, 2003)

Helena Strömberg, Anneli Selvefors & Sara Renström (2015) *Mapping out the design opportunities: pathways of sustainable behaviour*, International Journal of Sustainable Engineering, 8:3, 163-172, DOI: 10.1080/19397038.2014.1001469, (Strömberg et al. 2015)

Therese (2016), *Customer care support Philips* oral reference by e-mail (2016-05-21) (Therese 2016, *Customer care support Philips* oral.)

Toaster articles (2016) *Toasters: The inside story*, Retrieved (2016-03-15) from <http://www.toaster.org/works.html> (Toaster articles 2016)

Warell, Anders; Nåbo, M. (2001) *Handling Product Identity and Form Development Issues in Design Management Using Design Format Modeling*, The Proceedings of the 11th International Forum on Design Management Research and Education Strategies. Boston, USA, June 9-12, 2002. (Warrel & Nåbo, 2001)

Warell, A. (2006). *Identity Recognition in Product Design: An Approach for Design Management*, Proceedings of the 13th International Product Development Management Conference. Milan, Italy. June 11-13, 2006. (Warrel, 2006)

Philip White, Steve Belletire & Louise St. Pierre (2004) *Okala ecological design- course guide*, Portland, OR: U.S. Environmental Protection Agency, 2004, (White et al. 2004)

Wikibooks (2016) *Wikijunior: How things work/toaster*, Retrieved (2016-03-15) from https://en.wikibooks.org/wiki/Wikijunior:How_Things_Work/Toaster (Wikibooks 2016)

Wikipedia (2016) *Brödrost*, Retrieved (2016-03-15) from <https://sv.wikipedia.org/wiki/Br%C3%B6drost> (Wikipedia 2016)

WMF Group (2016) *Code of Conduct PDF*, Retrieved (2016-02-10) from http://www.wmf.com/media/wysiwyg/Rechtliches/WMF_Group_Code-of-Conduct_EN.pdf (WMF Group 2016, *Code of Conduct PDF*)

WMF (2016) *WMF KITCHENminis*, Retrieved (2016-02-10) from <http://www.wmf.com/en/collection-wmf-kitchenminis.html> (WMF 2016, *WMF KITCHENminis*)

WMF (2016) *WMF Coffee machines*, Retrieved (2016-05-24) from <http://www.wmfcoffee.com.au/about-wmf-coffee-machines/> (WMF 2016, *WMF Coffee machines*)

G. Wood & M. Newborough (2002) *Dynamic energy-consumption indicators for domestic appliances- environment, behaviour and design*, Science direct, Energy and Buildings 35

(2003) page 821–841, School of Engineering and Physical Sciences, Heriot-Watt University, Edinburgh, Scotland EH14 4AS, UK, (Wood & Newborough, 2002)

Woodford, Chris. (2011) *Electric kettles*. Retrieved (2016-03-17) from <http://www.explainthatstuff.com/how-electric-kettles-work.html> (Woodford 2011)

Zafarmand, S.J., Sugiyama, K., Wantabe, M. (2003) *Aesthetic and sustainability: The aesthetic attributes promoting product sustainability*, *The Journal of Sustainable Product Design* 3, p173–186, Chiba University, Japan, DOI 10.1007/s10970-005-6157-0 (Zafarmand, Sugiyama & Wantabe, 2003)

Image references

Chapter 1

Figure 1.1: Eco car: [http://www.auto-power-](http://www.auto-power-girl.com/wallpapers/highresolution/dacia_logan_eco2/30555)

[girl.com/wallpapers/highresolution/dacia_logan_eco2/30555](http://www.auto-power-girl.com/wallpapers/highresolution/dacia_logan_eco2/30555)

Washing machine & Refrigerator: Figure belongs to the company Electrolux

Figure 1.2: Figure belongs to the company Electrolux

Figure 1.3: <https://www.chalmers.se/sv/om-chalmers/profil-och-identitet/Sidor/logotyp.aspx>

Figure 1.4: Figure belongs to the company Electrolux

Chapter 2

Figure 2.1: Belongs to the project group

Figure 2.2: Belongs to the project group

Figure 2.3: Belongs to the project group

Chapter 3

Figure 3.1: Anneli Selvefors, Karin Blindh Pedersen & Ulrike Rahe (2011) Design for Sustainable Consumption Behaviour - Systematising the use of Behavioural Intervention Strategies, DPPI'11 Proceedings of the 2011 Conference on Designing Pleasurable Products and Interfaces, Article No.3, (Selvefors et al. 2011)

Figure 3.2:

Figure 3.3: Figure belongs to the company Electrolux

Figure 3.4-3.6: Belongs to the project group

Figure 3.7-3.8: Figure belongs to the company Electrolux

Figure 3.9: Belongs to the project group

Figure 3.10-3.15: Figure belongs to the company Electrolux

Chapter 4

Figure 4.1-4.11: Figure belongs to the company Electrolux

Figure 4.12: [https://i.guim.co.uk/img/static/sys-](https://i.guim.co.uk/img/static/sys-images/Guardian/Pix/pictures/2012/9/17/1347888330634/Save-Food-from-the-Fridge-007.jpg?w=700&q=55&auto=format&usm=12&fit=max&s=46ce00386c7ac4d1c92106b29b499849)

[images/Guardian/Pix/pictures/2012/9/17/1347888330634/Save-Food-from-the-Fridge-](https://i.guim.co.uk/img/static/sys-images/Guardian/Pix/pictures/2012/9/17/1347888330634/Save-Food-from-the-Fridge-007.jpg?w=700&q=55&auto=format&usm=12&fit=max&s=46ce00386c7ac4d1c92106b29b499849)

[007.jpg?w=700&q=55&auto=format&usm=12&fit=max&s=46ce00386c7ac4d1c92106b29b499849](https://i.guim.co.uk/img/static/sys-images/Guardian/Pix/pictures/2012/9/17/1347888330634/Save-Food-from-the-Fridge-007.jpg?w=700&q=55&auto=format&usm=12&fit=max&s=46ce00386c7ac4d1c92106b29b499849)

<https://blog.positiveluxury.com/2014/01/5-trends-2014/>

[https://s-media-cache-](https://s-media-cache-ak0.pinimg.com/736x/6f/d7/2c/6fd72c7a731859562cc5ed142c5d35a0.jpg)

[ak0.pinimg.com/736x/6f/d7/2c/6fd72c7a731859562cc5ed142c5d35a0.jpg](https://s-media-cache-ak0.pinimg.com/736x/6f/d7/2c/6fd72c7a731859562cc5ed142c5d35a0.jpg)

[https://s-media-cache-](https://s-media-cache-ak0.pinimg.com/736x/df/09/33/df0933fbf37d45f193e5a8142ca01113.jpg)

[ak0.pinimg.com/736x/df/09/33/df0933fbf37d45f193e5a8142ca01113.jpg](https://s-media-cache-ak0.pinimg.com/736x/df/09/33/df0933fbf37d45f193e5a8142ca01113.jpg)

Figure 4.13: [http://g01.a.alicdn.com/kf/HTB1wd7NHVXXXXXPXXXXq6xXFXXXR/300-](http://g01.a.alicdn.com/kf/HTB1wd7NHVXXXXXPXXXXq6xXFXXXR/300-pcs-lots-Rainbow-digital-watch-colorful-stripe-band-LED-watch-women-men-sports-watches.jpg)
[pcs-lots-Rainbow-digital-watch-colorful-stripe-band-LED-watch-women-men-sports-](http://g01.a.alicdn.com/kf/HTB1wd7NHVXXXXXPXXXXq6xXFXXXR/300-pcs-lots-Rainbow-digital-watch-colorful-stripe-band-LED-watch-women-men-sports-watches.jpg)
[watches.jpg](http://g01.a.alicdn.com/kf/HTB1wd7NHVXXXXXPXXXXq6xXFXXXR/300-pcs-lots-Rainbow-digital-watch-colorful-stripe-band-LED-watch-women-men-sports-watches.jpg)

[http://3.bp.blogspot.com/_aZ1jPk_mN9M/TL7yu36bupI/AAAAAAAAACPE/TF4rHQ8ZP7o/s](http://3.bp.blogspot.com/_aZ1jPk_mN9M/TL7yu36bupI/AAAAAAAAACPE/TF4rHQ8ZP7o/s1600/hanger_tea+copy.jpg)
[1600/hanger_tea+copy.jpg](http://3.bp.blogspot.com/_aZ1jPk_mN9M/TL7yu36bupI/AAAAAAAAACPE/TF4rHQ8ZP7o/s1600/hanger_tea+copy.jpg)

<https://www.divapor.com/images/taps/taps2.jpg>

[https://s-media-cache-](https://s-media-cache-ak0.pinimg.com/236x/17/e5/e9/17e5e984266f113d840a87e10ea7154c.jpg)

[ak0.pinimg.com/236x/17/e5/e9/17e5e984266f113d840a87e10ea7154c.jpg](https://s-media-cache-ak0.pinimg.com/236x/17/e5/e9/17e5e984266f113d840a87e10ea7154c.jpg)

Figure 4.14: Figure belongs to the company Electrolux

Figure 4.15: http://www.philips.se/c-p/HD9340_90/avance-collection-vattenkokare

http://www.philips.se/c-p/HD2696_90/avance-collection-broedrost

[http://images.philips.com/is/image/PhilipsConsumer/HD7689_00-P3D-global-001?wid=461&hei=335&\\$jpglarge\\$](http://images.philips.com/is/image/PhilipsConsumer/HD7689_00-P3D-global-001?wid=461&hei=335&$jpglarge$)

Figure 4.16:

http://www.wmf.com/media/catalog/product/cache/2/image/702x454/9df78eab33525d08d6e5fb8d27136e95/w/m/wmfce_kuechenminis.png

Figure 4.17: http://www.wmfcoffee.com.au/wordpress/wp-content/uploads/about_green_hero.jpg

Figure 4.18: http://applications.nam.lighting.philips.com/blog/wp-content/uploads/2013/02/Philips-Lighting_image03.jpg

Figure 4.19: <http://www.thedieline.com/blog/2014/5/2/obh-nordica>

Figure 4.20-4.56: Belongs to the project group

All other figures and tables belongs to the project group

Appendices

Appendix I	Design form analysis (DFA)
Appendix II	Survey, result
Appendix III	Interviews, result
Appendix IIII	User tests, planning and results
Appendix V	Geneva emotion wheel
Appendix VI	Semantic word scale
Appendix VII	What a designer can change
Appendix VIII	The Guidelines
Appendix IX	Workshop 2

Appendix I

Design Form Analysis

Generellt för Electrolux:	Brödrost:
<p>Använder markerade horisontella linjer - explicit 2-3 material (synliga) Relativt stora funktions "knappar" svart plast/metall med färgval tillgängligt stora handtag robust kompakt logga centrerat</p>	<p>har fötter stora radier på kanterna 3 grunddelar Markerad botten och topp, materialbyte eller linje, radie. Nedåt funktionsknappen är på höger sida på de produkter som har funktionsknappar på en framsida. Alla funktionsknappar är samlade Knappar dimensionerade efter frequency of use. Markerade knappar i annan färg/annat material ingen konsekvens i placering av loggan</p>
Kaffebryggare:	Vattenkokare:
<p>har fötter rak silhuett framifrån alt lite timglas formad markerade handtag och topp Markerade knappar, sitter ofta framtill markerade lock, linje och material - I markerad topp, linje och material stora radier, ingen kantig. markerat kaffekanne-utrymme, hål, färg, material, kantig ingång som ett avbrott från resten av formen. 4 grunddelar visar antal koppar</p>	<p>mjuka handtag, stora, markerade med annat material. ledsen delfin 4 grunddelar runda former har mått på sidan eller metallen har i plasthandtaget, måste vara på en plastdetalj? Handtaget delas ofta upp i två delar av en linje eller ett materialbyte. Locket är markerat på samma sätt som botten, med material och/eller att formen går in. Markerad pip, storlek och material, Bottendel ofta markerad, material eller linje eller bredd (bredare nertill) cylinder-, ägg- och konformer. Knapp placering ofta nertill, funktion eller knowledge in the world? Funktion till locket är placerat nära/på locket.</p>

SUSTAINABLE FEATURES	UNSUSTAINABLE FEATURES
Few materials	Plastic materials
Simple forms	Showy
Few details	Energy crook
Simplicity	Unnecessary
Honesty	Colorful
Vegetation	Fragile
Raw materials (copper, wood)	Purchase and dispose
Unadorned? (avskalat)	Not filling their function
Visible functions	Cheap
Function based	Massive and heavy
Hygienic	Easy and plastic
Minimalistic	Extra components
Dove colors	Extra materials
Calm colors	Childish
Reusable	Hard to recycle
Recyclable	Mixed materials
Luxurious	Palpable electronics
Calm expression	
Earthy	
Information of the product	
Minimizing the amount of materials	
Optimized material use	
Contrasts	
Clean text	
Easy to separate the materials	
Distinct	
Clean surface	
Matt/shiny surface	
Basic geometries	
Easy to handle	

Appendix II

Survey

General questions:

Age

<20	0%
21-30	64.2%
31-40	5.5%
41-50	8.3%
51-60	16.5%
61-70	3.7%
>70	1.8%

Gender

Female:	62.4%
Male:	35.8%
Other:	1.8%

I live in a...

House	35.8%
Apartment	37.6%
Student apartment	25.7%
Other	0.9%

I live in a...

Town	78.5%
Village	13.1%
Countryside	6.5%
Suburb	0.9%
Other	0.9%

Toaster:

Do you have a toaster?

Yes	80.6%
No	19.4%

How long have you had your current toaster?

6 month	4.5%
1-2 years	11.4%
3-4 years	26.1%
5-6 years	19.3%
7-8 years	19.3%
9-10 years	3.4%
>10 years	15.9%

How many years would you expect a toaster to function?

6 month	0%
1-2 years	2.2%
3-4 years	6.7%
5-6 years	14.4%
7-8 years	14.4%
9-10 years	14.4%
>10 years	47.8%

How often do you use your toaster?

A couple of times every day	2.3%
Once a day	5.7%
A couple of times a week	21.6%
A couple of times a month	40.9%
More seldom	29.5%

Do you use all the functions on your toaster?

Yes	57%
No	43%

How many slices do you toast each time?

1	5.6%
2	75.3%
3	2.2%
4	15.7%
5	0%
6	1.1%

Do you remove the plug from the outlet when you are done toasting?

Yes	58%
No	42%

How do you store your toaster?

In a drawer	10.2%
In a cabinet	43.2%
On a shelf	11.4%
It is always on display	35.2%
Other	0%

Would you like to add anything about your toaster or toasters in general?

(10 svar)

The less paid the bigger smile
No
I would not repair it
Connected to a timer outlet
If you just want one toast, there should be a function to not warm the whole toaster up. Example mine holds 4 slices of bread, but I never use the two extra slots. But the whole thing heats up like its going out of style.
the last question is faulty, there are better options here then in the previous option and we have no frame of reference
It is hard to consider the sustainable question when the word sustainable has no clear definition. Economic, Ecologic, societal, energy, material etc etc.
Toaster cost for repair is irrelevant if I dont know how much it would cost to fix it.
I inherited mine from my grandmother :D
When I buy a new toaster it's also important to me that has got a stylish design.

Kettle:Do you have a kettle?

Yes 82.6%

No 17.4%

For how long have you had your current kettle?

6 month 10.1%

1-2 years 20.2%

3-4 years 25.8%

5-6 years 24.7%

7-8 years 11.2%

9-10 years 4.5%

>10 years 3.4%

How many years would you expect your kettle to function?

1-2 years 1.1%

3-4 years 12.4%

5-6 years 23.6%

7-8 years 10.1%

9-10 years 19.1%

>10 years 33.7%

How often do you use your kettle?

A couple of times every day 40.4%

Once a day 14.6%

A couple of times a week 22.5%

A couple of times a month 15.7%

More seldom 6.7%

Do you use the measurement system when estimating the amount of water?

Yes, in deciliters 46.7%

Yes, in numbers of cups 3.3%

I only use it on rare occasions 24.4%

No, I do not use it 25.6%

Which of the following is correct when you use the kettle:

I usually boil too much water 71.1%

I usually boil to little water 1.1%

I usually boil the exact amount of water that I need 27.8%

Do you save the extra water if you boil too much?

Yes 33.3%

No 27.8%

Sometimes 30%

I do not boil too much 8.9%

How many cups do you boil each time?

1 8.2%

2 22.4%

3 22.4%

4 24.7%

5 8.2%

6 4.7%

7 9.4%

Do you remove the plug from the outlet when you are done using the product?

Yes 40%

No 60%

How do you store your kettle?

In a drawer 3.3%

In a cabinet 16.7%

On a shelf 13.3%

It is always on display 65.6%

Other 1.1%

Would you like to add anything about your kettle or kettles in general? (15 svar)

Köpte den för 69 kr på Ica år 2010, fungerar fortfarande hur bra som helst!

After a while it looks rusty in the bottom which is not very nice. I Like kettles in glass where you actually can see the water, feels more clean

I use a kettle that boil the water just in time as it is poured = no waste

No

I do not consider that

Connected to a timer outlet

I use it everytime I need hot water. The most common example would probably be when Im gonna boil something on the stove. I heat the water in the kettle first, and pour it in to the pan. I rarely measure the amount of water that Im heating, I just fill up what I think I need, but usually end up pouring a lot of excess weater in the sink.

Kettle mostly used to boil water for egg-boiling.

There should be an included kit to clean it from limescale. A friend of mine bought a new kettle rather than cleaning the old one. He is kinda weird though.

I've 'repaired' minor faults on my kettle several times

The repair thing is mainly if i can do any repairs myself otherwise no.

My kettle costed 250 sek. I would not spend more on it as a student.. However I would pay a bit more if it is a sustainable one (300-350 sek).

The minimum of water that you must boil (indicated on my kettle is 0,5L) is already more than what I need for one cup of tea.

Again, I cant comment on the cost of a new kettle if I dont know how much repairing it would cost. Ohh... and how much is a cup? Join the metric world, we ARE smarter!

Would buy a new one instead. Don't know if someone can repair in Town.

As mentioned above, the design is also important to me when buying a new kettle.

Coffee Maker:

Do you have a coffee maker?

Yes 71.7%
No 28.3%

For how long have you had your current coffee maker?

6 month 10.4%
1-2 years 27.3%
3-4 years 32.5%
5-6 years 10.4%
7-8 years 13%
9-10 years 1.3%
>10 years 5.2%

How many years do you expect your coffee maker to function?

6 month 1.3%
1-2 years 2.6%
3-4 years 9.2%
5-6 years 18.4%
7-8 years 11.8%
9-10 years 22.4%
>10 years 34.2%

How often do you use your coffee maker?

A couple of times every day 26%
Once a day 23.4%
A couple of times a week 23.4%
A couple of times a month 14.3%
More seldom 13%

Do you use the measurement system when estimating the amount of water?

Yes, in deciliters 7.9%
Yes, in numbers of cups 80.3%
I only use it on rare occasions 1.3%
No, I do not use it 10.5%

How many cups do you brew each time?

1 7.8%
2 10.4%
3 14.3%
4 23.4%
5 13%
6 15.6%
7 2.6%
8 6.5%
9 0%
10 6.5%

Which of the following is correct for when you use the coffee maker:

I usually make too much coffee 32.5%
I usually make too much coffee 2.6%
I usually make the exact amount of coffee that I need 64.9%

Do you save the extra coffee if you brew too much?

Yes 13%
No 50.6%
Sometimes 15.6%

I do not brew too much 20.8%

Do you remove the plug from the outlet when you are done using the product?

Yes 40.8%
No 59.2%

How do you store your coffee maker?

In a drawer 2.6%
In a cabinet 13%
On a shelf 18.2%
It is always on display 66.2%

Would you like to add anything about your coffee maker or coffee makers in general?

(12 svar)

My coffee maker cost 150 SEK.. So I would not buy a new one just because it is sustainable. If it breaks I would buy a new cheap one that cost less than 250 SEK

I have a presso bryggare in Swedish :) thus, I'm only using the kettle

I like glass better than plastic, doesn't feel good to boil water in a plastic container.

We use a "perculator" therefore no answer about filters

No

Also connected to a timer outlet

It's a capsule machine. I wish I could make my own capsules.

Timer

Cost of repair and the metric stuff... Again....

I had one when I was a kid that was much better: Dora! You met her when you were in Brazil! ;-)

Would buy a new one instead. Don't know if someone can repair in Town.

As mentioned above, the design is also important to me when buying a new coffee maker.

Appendix III

Interview

	IP1	IP2	IP3	IP4	IP5	IP6	IP7	IP8	IP9	IP10
Kön	Kvinna	Man	kvinna	man	kvinna	kvinna	Kvinna	man	man	Kvinna
Ålder	25	24	23	59	54	25	51	20	60	24
Antal i hushållet	2	1	1	2	2	2	2	2	1	2
Boendeform	lägenhet	lägenhet	lägenhet	hus	hus	lägenhet	villa	villaradhus	lägenhet	

	IP11	IP12	IP13	IP14	IP15
Kön	Kvinna	Man	kvinna	kvinna	man
Ålder	24	36	27	26	24
Antal i hushållet	1	1	2	2	2
Boendeform	lgh	villa	lgh	lgh	lgh

Generella frågor

Q2: Förklara din morgonrutin

IP1- Går upp och sätter på vattenkokaren först, har pressokaffe, lägger i pulver rör om och låter stå. Finns minimi nivå, kollar man på, sätter på lagom med vatten. Brödrost anv. mest när de ska äta hamburgare. Kaffekokare har inte, har haft, bara hon som dricker kaffe, stor klumpig, blev så mycket över som hon fick hälla ut.

IP2- Jag använder ingen brödrost på morgonen, har inte den typen av bröd hemma. Den är klumpig det är alltid smulor. Kaffe behöver jag tid för på morgonen, oftast skippar jag kaffe helt, espresso på helgerna Jag behöver inga elektriska produkter på morgonen, ev. för gröt. På helgen tar jag kaffe, efter en timme ca från att ha vaknat eller så tar jag te, dricker mest te på kvällen. lagar i vatten kokare, men den används främst för matlagning.

IP3- Jag går upp och sätter på kaffe, gör 2 koppar men använder ca 1,5, det är alltså alltid lite kvar, rostar bröd om den står framme och jag har bröd, om brödet ligger i frysen och rosten i skåpet blir det ingen rost macka, använder den ca 1gång i mån ca 1-2 mackor

IP4- går upp, sätter på kaffe tar fram frukosten, äter frukost

IP5- sätter på kaffe, rostar bröd om annat bröd är slut, kaffe är viktigt på morgonen, har ingen vattenkokare och ser ingen nytta med det med induktionsspis, jag äter frukost läser tidning sen gör jag mig i ordning, sitter alldeles för länge och får bråttom varje morgon, dricker kaffe sen borstar jag tänderna, ger katten medicin

IP6- går upp, duschar, klär på mig, gör frukost att ta med, ibland om jag har tid kokare jag te på morgonen

IP7- Går upp och duschar först, äter frukost sen och går ut med hunden.

IP8- Jag kokar tevattnen och går ner i frysen och hämtar mackor som jag brukar antingen värma i Micro eller rosta. Sen så brukar jag göra te och kaffe, både och. Först dricker jag en stor kopp te och sen dricker jag kaffe på morgonen. Sen borstar jag tänderna.

IP9- Upp 4.30, göra mig i ordning, läsa tidningen, dricker te, klockan 6 titta på rapport, cykla till jobbet.

IP10- Vaknar, sätter på kaffe först av allt, medan det är på åter jag bröd, brukar ha fryst, är det inte fryst använder jag inte brödrosten, typ lika ofta, ibland mikrar brödet. Glas juice, äter. Beror på tiden, kan ta kaffet på jobbet också.

IP11- Klockan ringer, äter frukost, borstar tänderna, stoppar matsäcken i väskan och går ut genom dörren. Vill sova så länge som möjligt alltså händer det så lite som möjligt på morgonen.

IP12- Går upp, letar kläder, tvättar av mig och äter frukost. Borstar tänderna och sticker till jobbet.

IP13- går upp, kokar kaffe, antingen till mig eller till båda, drar ut sladden, brukar ha vatten i kannan som jag brukar hälla ut sen nästa gång, har på känn hur mycket vatten jag behöver men vet inte exakt vad det är, kaffebryggaren står sen på till pojkvännen går upp en timme senare drar ut sladden. en gång i halvåret rengör jag den med ättika, diskar inte varje gång, gör i ordning mig medan den kokar, jag har en tajt morgon rutin, brer mackor och kollar tv, kokar 2 koppar kaffe

IP14- Jag rostar bröd varje morgon men just nu har jag ingen vattenkokare så om jag dricker te så är det ca 2ggr i veckan och då kokar jag det i kastrull men jag ska köpa en snart. Jag äter först sen sminkar jag mig och gör mig iordning, men äter först, annars fungerar jag inte, måste få energi,

IP15- brödrost använde jag för längesen nu, jag går upp, duschar, kollar om det finns nått att äta, kollar klockan och antagligen hinner jag inte och då får jag smöra en macka samtidigt som jag klär på mig och ta med mackan till skolan, om jag hinner så kan jag dricka te och då sätter jag på kokaren innan duschen men dricker den efter duschen

Q5: Vad tänker du kring din vattenkokare?

IP1- Den är rätt ful, fast den var sambons från början. Den har konstig färg i botten (vet inte om den stått på tom? vatten ett tag) känns lite dåligt, kan det släppa grejer i vattnet? Man vill ju att det ska se ut som vattnet är för sig själv, inte blandas med något konstigt. Annars bra, klick så åker locket upp och man fyller på, de flesta har väl så. Känns klumpigt att den står på plattan och har så kort sladd! Hade uppskattat trådlös... den är så begränsad var den kan stå. Alltid inkopplad. Lyser rött när den är igång och så klickar den. 5 år kanske.. just med missfärgningen, dax att byta ut. Man vet ju inte, men det verkar äckligt.

IP2- Den rymmer för lite för matlagning, endast en liter, kan heller inte koka för lite, typ för en mugg, blir alltid vatten över som hälls ut. Den är rätt liten vilket är bra så den får plats, jag har inte mycket plats hemma, placerar kannan i skåpet och plattan bredvid, hade varit bra om det gick att fälla ihop den, har den förvarad i ett skåp, ska den vara framme så ska den vara smidig och vara riktigt snygg, ser för plastiga ut

IP3- Jag har ingen vattenkokare här i Sverige, jag tycker de blir äckliga för det ligger alltid något vitt i botten så det är fräschare på kastrull, det är äckligt inuti för det blir vita lager som kommer ut i koppen när man håller upp det, de fastnar även på koppen, det blir inte så med kokat vatten från kastrull. man måste även hela tiden städa ut den och stoppa i ett medel så den inte blir äcklig (man gör det i England tydligen, ev. kalkmedel). det är dock bra med vattenkokare iom att det är snabbt och smidigt (om den är ren), kan även använda den när man lagar mat då går det fortare

IP4- -

IP5- -

IP6- den är rätt ny och känns rätt tung, den tar relativt lång tid på sig jämfört med den gamla, men ser rätt ok ut

IP7- Jag tänker inte så mycket, jag kokar vatten med den. Den är alltid inkopplad, sladden sitter alltid i. Jag använder den jättemycket. Det händer att jag använder den till att koka upp vatten till matlagning men det är inte så vanligt.

IP8- Den funkar, den gör det den ska lixom. Jag brukar inte tänka så mycket på den. Den är alltid inkopplad.

IP9- Jag tänker inte så mycket, jag använder inte så, så mycket faktiskt. Men när jag kokar pasta t.ex. på lunchen då kokar jag vattnet först i vattenkokaren, för att spara energi, just precis. Inte alltid inkopplad, kopplar ur den när jag går ut på morgonen och kopplar in igen på kvällen när jag ska koka te.

IP10- Jag vill att den ska vara snabb, och det jag har tänkt på är att minimumstrecket är förmycket vatten, man måste alltid fylla på förmycket.

IP11- Den kokar vatten... den fungerar bra, värmer snabbt. Den gör det den ska.

IP12- tänker att den är, den ska vara effektiv, lätt att lyft av i från bottendelen med sladd, den ska rymma flera koppar så att man ska kunna göra en kopp om man bara vill göra till sig själv men om man har gäster ska det räcka till 5-6 koppar. Det ska vara en tydlig skala som är lätt at läsa av.

IP13- när jag hade den gamla delade jag den med flera, den svartnade i botten så jag fick slänga den, när jag köper en ny skulle jag kolla på en som inte är i plast, en som kanske är i rostfritt stål, jag skulle köpa en bra som håller länge snarare än en billig

IP14- -

IP15- känns billig och inte så jätte-nice men den gör jobbet, man vill ju bara få varmt vatten men den är lite seg

Q6: Vad tänker du kring din kaffekokare?

IP1- har funderat på att köpa en, vill ha espresso och bryggare in ett, gillar multifunk. Så att jag slipper ha en massa maskiner ståendes!

IP2- Bryggkaffe, gammal kaffekanna, manuellt filter, fyller på med vatten från vattenkokare

IP3- den är rätt gammal, den är dryg för att den känns smutsig och man ska byta vattenfiltret men vet inte hur man gör så det är bara äckligt, men den funkar och gör det den ska,

IP4- den är hyfsad bra, sköter sig, den har en bra design, väldigt enkel

IP5- snygg, tycker om den, den gamla gick sönder men köpte likadan för den är fin och annorlunda, snygg design, ibland är den för liten och rymmer för få koppar, endast 8 st så ev lite större, inte så mycket mer

IP6- -

IP7- -

IP8- -

IP9- Samma, jag kokar mest te i den. Drar ut sladden samtidigt som tekokare. Kokar en kanna på morgonen och en på kvällen.

IP10- Att det, den får inte vara förlångsam, min nuvarande är jättesnabb. vill att den ska stänga av sig själv efter typ 2h. Ska vara lätt att se strecken hur mycket kaffe man ska ha. Den ska hålla länge, och vara snygg. Alltid inkopplad.

IP11- Alltså inte mer än samma, den gör det den ska och jag får gott kaffe, vet inte om du är ute efter något speciellt men nä.. den är min bäst vän.. höhö

IP12- Ungefär samma sak va, den ska också vara lätt att fylla på kaffet i filtret, lätt skala, ska räcka till en person och flera. Det ska inte kännas onödigt att bara koka en kopp. Ska vara enkelt att fylla på vatten, tycker det är lite bökigt som det är nu. Vårans espressomaskin är bättre för där kan man ta av vattenbehållaren och fylla på, jämfört med kaffekokaren där man måste krångla sig in under ett skåp för att fylla på. Det är viktigt att den får plats på köksbänken även om den står under ett skåp, att man kan öppna lucka helt upp och slipper stå och hålla den med en hand samtidigt som man ska hålla.

IP13- den är bra, enkel en vanlig bryggare, det känns inte onödig för den gör det vi behöver, går hyfsat fort, skulle inte klara av om den tog lång tid, då skulle jag köpa en ny, graderingen på bryggaren är intryckt i plasten så svårt att se men lär sig efter hand.

IP14-
IP15-

Q7: Vad tänker du kring din brödrost?

IP1- Uttag man slår på och av, kan man klicka på när man kommer hem, men alltid inkopplad där. Fick av sin moster, kvitto och allt. Vet inte om den fick vatten på sig? Ser ut som ett rymdskepp. Har galler man kan sätta på, men har aldrig använt det... vet inte vad gallret är till för? Tänkte att det var käckt i början, anv. den inte så ofta ändå så den får stå där...

IP2- Den tar mycket plats fast den bara rymmer två bröd, den står långt inne i skåpet och det är jobbigt att ta ut den för jag måste flytta på andra grejer innan och stå på stol för att nå den. Bra med en brödrost som kan göra samma sak som micro- nybakadkänsla, inte heller begränsad till att brödet sticket upp även om det inte är de klassiska brödsnivorna. Gillar den på hotell som roterar, kan ej bli brända. Vad är värdena på brödrosten- minuter eller värme? är olika för alla bröd. Jag trycker på stopp. allting kring den är för krångligt för att jag ska använda den, har jag bröd i frysen använder jag ugn. Spelar ingen roll vad man gör det blir ändå inte bra. har i dem för lite för att de inte ska bli brända

IP3- den är gammal och jag skulle vilja ha en ny, det går snabbt att rosta men skulle vilja ha en ny i fin och cool färg och en liten för ca 2 mackor. den har bara en funktion, vill bara ha ett rostat bröd så behöver inte många funktioner. det är jobbigt med alla brödsmlor, hade varit bra att kunna tömma den på ett annat sätt än att vända upp och ner på den, och om man flyttar den åker smulor ut

IP4- gammal och bränd på toppen, skruttig men den funkar

IP5- ful, klumpig, tar för mycket plats och kan inte ha den framme, man får vakta den, lyckas aldrig få rätt temperatur iom att jag använder den för sällan antingen blir det för lite rostat eller för mycket, brödostar är fula saker

IP6- den är ganska liten, funkar rätt bra men det blir mycket smulor runtom

IP7- Jag vet inte, jag tänker inte så mycket. Den har jag i ett skåp och när jag vill rosta bröd så tar jag fram den och när jag har rostat färdigt så ställer jag undan den. 2 skivor, den är ganska ny.. 1 år. Förväntar mig att den ska hålla minst 10 år.

IP8- Brukar försöka matcha värmen på sidan för att jag inte ska bränna brödet. Jag brukar dock ha kvar samma inställningar, brukar mest rosta frysta mackor så då blir det liksom samma sak. Idag sänkte jag den till exempel eftersom jag tänkte rosta baguette, men det gick sådär.

IP9- Jag tänker inte därför att jag använder den sällan. Men jag använder den ibland när jag har besök av folk som kommer under helgen. Men annars, det är sällan jag använder den. Nja, ibland glömmar jag att koppla ur den men jag försöker att komma ihåg att dra ut den.

IP10- Den ska vara snygg, vill ha matchande saker, utseendet är ganska viktigt, känns som alla uppfyller samma funktioner. Använder jätte ofta cancel-knappen. Kunna ha olika längd.. Kan gärna vara lätt att få upp brödet, för det är lite svårt ibland. Hopp-upp-funktion på brödet har mina föräldrar.

IP11- Jag har en.. men den står i ett skåp så jag använder inte den så mycket.

IP12- Jag gillar den som vi har där man ser att den är igång, att den har ett defrost läge, att man kan enkelt poppa upp brödet, de hamnar gärna långt ner så det är svårt att få upp dem. Det får gärna vara fyra mackor även om det kanske är lite onödigt, men är man två eller fler är det ju bra. Ska bara lätt att ställa in skalan. Tydlig cancel-knapp.

IP13- för två mackor, ärvd, bra gör sitt jobb, gör det när jag är bakis

IP14- den är bra, har en vanlig standard rost som är ärvd av mans föräldrarna, jag tar vad jag får och jobbet blir gjort, jag behöver inget fancy

IP15- det är att den ger olika resultat vilket är frustrerande spec när mackorna kommer från frysen, då får man ofta rosta en och en halv gång, man vet inte när de är klara .hade varit bra om nån sa att "den är nu gyllenbrun och frasig klar"

Q8: är det något du saknar?

IP1- Kaffebryggare, när det kommer folk och så, kan inte göra så mycket i pressen. Funk- att man kan brygga flera koppar. Espresso- göra en enkel till sig själv och micra mjölk att hålla i. Då kanske inte vattenkokaren behövs så ofta... Brödrosten justerar man bara värmen...2 rattar, sänk värmen det är det man vill ha. Vattenkokaren skulle kanske vara, om man ska göra te ska vattnet inte koka, hade varit nice att kunna ställa in avslutnings-temp, nu bara slutar den när det kokar. Vill inte att det ska koka.

IP2- Inget minimum ska finnas, den ska inte vara mer ineffektivt om du kokar mindre vatten, känns som att all värme går ut i omgivningen så de bör vara mer isolerande. den blir så varm så jag inte vill lägga in den i skåpet- måste låta den svalna, funderar på en vanlig kaffebryggare för att det är smidigt, gått och kollat men gillar inte riktigt de som finns på markanden är mer intresserad av en elektrisk kvarn

IP3- nej

IP4- nej båda är väldigt enkla, inga avancerade funktioner och ser inget behov av

IP5- brödrostar skulle kunna vara snyggare och nättare, så de kan stå framme, rostat oftare

IP6- nej

IP7- nej

IP8- Nää. I början när man "lärde känna" vatten kokaren hade det varit bra att veta liksom hur många koppar som är på varje, den visar bara i deciliter, men sen lr man sig efter ett tag vad som är en kopp liksom.

IP9- Nej, faktiskt inte

IP10- Billigare priser på bra kaffekokare... tydligt det här med garanti och sådana saker, svårt att se idag. Kaffekokaren ska stänga sig själv ifall man skulle glömma är det superbra!

IP11- nej, det tycker jag faktiskt inte.

IP12- Det är ju lite gammaldags, det känns ju som att det inte hänt så mycket med tekniken, de känns primitiva. Så mycket annat har gått så snabbt framåt.

IP13- mer tydlig gradering på bryggarhållaren, bra sladdlängder kan vara ett störmoment men inte på dessa, vi köpte en timer men fattade inte hur den funkade så nu drar vi ut sladden

IP14- ne, kanske om den gick lite snabbare, den tar lite tid

IP15- ah det är tidsanvisning, tex vattenkokaren låter som den är klar men det är den inte, det hade varit bra om man kunde se tiden det var kvar typ 10 sek eller liknande, samma för brödrosten

Design for sustainable behaviour

Q16: Måttangivelsen, hur används den?

IP1- Minimi vatten, ser till att alltid vara över- lite extra nu då. Koka till ris, när man vill att det ska gå fort tar man upp till max gränsen men är ganska noga att vara inom dessa, de är väl där av en orsak. Kollar inte skala mellan, går på känsla, man måste pausa och kolla och vattnet gungar, det tar bara tid.

IP2- Jag använder den för max angivelse men mer för att laga mat, annars höftar man. på espresso finns en tank man kan använda flera dagar utan att byta, jag fyller inte på så mycket, tar bara så mycket vatten den precis behöver och mha tryck- kan vara mer energikrävande

IP3- ja på kaffekokaren men inte på vattenkokaren (i London) isf ibland med ögonmått, kollar inte på siffrorna för det känns som man inte slösar så mycket- det är ju bara vatten, med kaffet blir det för svagt och för starkt om man inte kollar

IP4- ja, i koppar

IP5- ja,

IP6- använder den inte alls, kör på känsla

IP7- Ja, nog i deciliter. Mer min och max gräns än för att mäta upp något specifikt..

IP8- Ja, det brukar jag göra, men det är ju såhär att jag vet ju att en liter vatten brukar räcka till två koppar ungefär, eller jag undrar om det är en liter egentligen... sen finns det nästa snäpp och nästa snäpp, har lärt mig vad literangivelsen motsvarar i koppar.

IP9- Ja, antal koppar på kaffekokaren, vattenkokaren använder jag inte. På vattenkokaren mest för min och max gränser

IP10- Ja, både på kaffekokaren och vattenkokaren, på kaffekokaren först och främst på hur många koppar jag ska göra så det blir lagom starkt. På vattenkokaren är det bara för att se så jag kommer över min gräns.

IP11- Inte så mycket till vattenkokaren, tar hänsyn till min och max (har testat maxgräns det bubblar över), men till kaffekokaren gör jag.

IP12- Vattenkokaren: fyller över min gräns men inte riktigt upp till max, gör jag alltid oavsett antal koppar. Kaffekokaren mäter jag väldigt nog för där är det väldigt relevant så man vet hur mycket kaffe man ska ta i.

IP13- känner men kollar efteråt, måste tända en lampa för att se dem

IP14- Jag håller vatten i ett glas och sen håller jag i det vattenkokare, då ser jag då hur mycket det ska vara och så kör jag på det sen, hade varit bra med en egen markeringsmöjlighet

IP15- jag höftar

Q17: Om man kokar förmycket vad gör man med det och varför?

IP1- Gillar inte det, då vill jag kunna göra något med det, något syfte, blötlägger. Brukar inte bli, håller upp i ingrodd kastrull och hjälper den på traven. Annars håller jag ut det så det inte står där och blir äckligt.

IP2- Håller ut det i diskhon eller på disktrasan, kaffe blir aldrig för mycket

IP3- vatten- hålla ut det inför nästa kopp, kaffe slänger jag

IP4- slänger det

IP5- blir stående i kaffe kannan och sen slängs de bort

IP6- antingen håller jag ut det nästa gång jag använder den, ibland håller jag ut det i diskhon direkt för att rensa ur lite smuts, ibland kokar jag på det igen nästa gång om det inte va så länge sen jag använde den sist

IP7- Jag låter vattnet vara kvar i men jag håller ut det nästa gång jag använder vattenkokaren.

IP8- ... och så blir det alltid lite vatten över, det brukar jag återanvända- låta det vara kvar i.

IP9- Kaffe slänger jag när det börjar bli kallt, men det är sällan jag kokar förmycket.

Vattenkokare jag slänger ut det men det är sällan också. Har jag förmycket varmt vatten då håller jag ut det.

IP10- Låter det vara (vattenkokare) och återanvänder, oftast!

IP11- Kaffe kan jag få för mig att värma upp, varmvattnet håller jag ut, oftast ner i disken så den blir uppblött. Havregrynsgröt sitter som sten!

IP12- håller ut kaffet dagen efter när jag ska koka igen, man vet ju aldrig om man blir sugen igen efter ett litet tag. Vattnet låter jag stå kvar och om det inte gått för lång tid så kokar jag upp samma vatten igen (handlar om timmar) har det stått flera dagar så håller jag ut det.

IP13- ber Niklas dricka det, minder än en dl som jag isf slänger ut

IP14- blir bara lite för mycket så det håller jag ut

IP15- låter det vara kvar i kokaren men sen nästa gång jag ska använda den slängs den ut

Q21: Skulle du vilja ha feedback?

IP1- Ja, det känns som jag har väldigt dålig koll på det faktiskt, på produkten eller extra grej. Vill inte ha någon jättestor grej, en lite skärm typ.

IP2- det är intressant men måste framföras på ett sätt som inte skapar obehag, skulle vara bra om produkten gör det åt dig

IP3- kan vara bra för att spara energi, eller kan ställa in hur mycket energi man vill använda eller en knapp för att stänga av hela helt

IP4- ja min elräkning är min feedback, inte intressant per produkt

IP5- inte så jag tänkt på det

IP6- nej, skulle inte bry mig tillslut

IP7- Ja

IP8- Ja, det hade varit kul, jag hade velat se det.

IP9- -

IP10- ja

IP11- Ja, det tror jag

IP12- Mh, det skulle jag vilja ha.

IP13- -

IP14- -

IP15- ja om det inte stör, men ja för att man har ju ingen aning om vad produkterna drar. jag ser ju inte att det eldas kol i polen för att jag kokar upp för mycket vatten

Q22: Skulle du använda en app? för att se energiförbrukning eller få tips och trix för miljösmart användning?

IP1- Ja alltså, jag skulle säkert ladda ner den, men hur ofta jag skulle anv. vet jag inte. Skulle vilja ha feedback direkt när jag sätter igång utan att hämta extra grej. mobilen har man ju inte när man lagar mat. Man har ju iofs tv och så, så det hade kunnat bli en tävling mot sig själv och kolla.

IP2- -

IP3- nej, på telefonen är det för mycket redan

IP4- nej, vill inte se för specifik maskin, isf totalen

IP5- nej

IP6- nej

IP7- Jag vet inte, men det kanske jag skulle. Jag hade nog behövt bli tipsad om den för jag är inte så bra på att leta upp sådana grejer själv. Men... ja det hade jag kunnat tänka mig. Men kan man göra det?

IP8- Ja, det hade väl... det hade jag kunnat använda.

IP9- Ja, därför det här är min grej, det tycker jag är kul.

IP10- Ja, det skulle jag.

IP11- Ja, det hade jag nog kunnat tänka mig att göra.

IP12- Jag skulle nog göra det ja, om den hade såhär bluetooth så man kunde synka den mot kaffekokaren och jämföra med energiförbrukning från dagen innan. men jag skulle nog inte använda den varje dag, skulle bli på helgen när man har lite tid över.

IP13- isf för hela lägenheten men inte för en produkt

IP14- ja

IP15- isf integrerat för alla produkter både total och för individuella produkter, så jag vet att vilka produkter som drar mest, ev en tävling som man kan koppla till ett socialt nätverk och tävla med sina vänner, tex så snackar man ju om källsortering och till slut hetsar man varandra och de som inte sorterade alls blir bäst och då tänker man själv att man inte kan vara sämre än den personen så då måste man bli ännu bättre själv, då blir man mer motiverad.

Design for disassembly

Q27: Hur viktigt är det med återvinning?

IP1- Jag tycker det är viktigt men jag är kanske inte jätteduktig med alltid, det blir jag ensam som får göra det då. Man blir ju mer och mer medveten, separerar matavfall och kartonger, pant.. lite dålig på att sortera plast. Man måste organisera och det tar plats! Man vill komma åt allt ordentligt. Innan var jag duktigare, går i perioder.

- IP2-** viktigt men det är jobbigt, återvinner inte plast, ska vara så lätt och tillgängligt som möjligt, tar plats och blir äckligt
- IP3-** det är viktigt men gör det inte själv, bra att många gör det och önskar att jag gjorde det. jag gör det om det är så enkelt som möjligt, och att man vet vart man ska slänga allt, är van vid London och att bara ha en sopgrej, om det finns en soptipp så skulle jag kunna slänga där men det händer inte så ofta, har lite sortering i lgh-huset men endast glas och plast men ej brännbart och mat.
- IP4-** det är viktigt, men kan känna att om den burken hamnar där eller där spelar det ingen roll men det är klart att det gör det i längden ändå
- IP5-** jag tycker det är viktigt och bra,
- IP6-** det är viktigt men nu är vissa produkter eller förpackningar sådana att man inte kan separera dem på ett bra sätt och då blir det ofta fel i återvinning
- IP7-** Det är viktigt, jag sorterar allt jag kan. Alla sopor och ja.
- IP8-** Det är väl viktigt, jag sop sorterar. Pantar flaskor
- IP9-** 100%, sorterar så mycket jag kan, på gränsen till för noggrann.
- IP10-** Det är viktigt att tänka på det, men har man inte det lätt tillgängligt blir det så mycket mer komplicerat och då blir det inte alltid att man gör det. Finns det gör jag det och då är det viktigt.
- IP11-** Viktigt, jag sorterar så mycket jag kan. man sorterar mer i Sverige än i Danmark, inte lättillgängligt.
- IP12-** det är viktigt känns som en sån där inarbetad grej.
- IP13-** jätte viktigt, känns att man gör något bra även om man inte vet om man gör det i slutändan, vi återvinner allt
- IP14-** jätte viktigt, för jag har alltid bilder i huvudet från när jag var liten av berg av skräp och djur som fastnar i grejer, lite skrämteknik som får mig att ändra beteende med, är också pga medkänsla för andra än sig själv, funkade för att man bryr sig gör man inte det så blir man inte skrämmd, krävs ett hjärta
- IP15-** jag tycker det är väldigt viktigt med jag gör inte vad som helst för det, det finns ju både bra och dåliga system, tex i vårt hus så finns ingen möjlighet för återvinning och då främjar de inte ett ändrat beteende, det gör det inte lättare för mig utan blir ett extra moment och att jag dessutom behöver gå flera kilometer för att slänga soporna gör det inte bättre men jag tycker det är väldigt viktigt och väldigt bra, jag tycker det är coolt att man kan göra nya produkter av gamla

Modultänk

Q31: Skulle du vara intresserad av en laddnings station? (t.ex. gemensam bricka, gemensam motor)

- IP1-** Om jag slipper sladdarna hade ju varit riktigt nice! Att man typ laddar upp den, använder sällan alla samtidigt. Det hade funkade. Det är om man kan ladda upp produkten i sig... Hade varit coolt, så produkten inte är sladdberoende. Frustrerande om den laddar ut.
- IP2-** skulle inte vilja ha batteri, sämst för miljön, går inte att separera, känns stort, blir en extra produkt
- IP3-** ja, men bra så man kan ladda under kvällen, om alla används så bra med alla samtidigt
- IP4-** känns lite komplicerat, så nej
- IP5-** nej kan inte svara på det, ser inte hur det skulle funka, allt måste vara praktiskt
- IP6-** nej tror det skulle vara för bökit
- IP7-** Njaa, det skulle jag nog kunna tänka mig. Jag använder dem inte samtidigt så ofta, det skulle inte begränsa mig, man kan ju göra tevattnet först och rosta macka sen..
- IP8-** Det hade varit lite coolt i och för sig.. fast det hade varit lite opraktiskt också för att då hade man ju inte kunnat rosta bröd och koka vatten samtidigt liksom. Och en sådan sak som att

koka kaffe kan ju ta lite tid, så då blir det ju, lite svårt att tajma sin frukost, att få allt klart samtidigt. Men det är kanske inte...det värsta som kan hända. Det blir till att ändra på en rutin... Jag hade nog varit mer för en gemensam laddningsstation.

IP9- Njä, jo det skulle vara kanske toppen men det skulle vara en sådan grej som man gör en två gånger och sedan vill man ha tillbaka de som har sin egen motor. Laddningsstation är mer aktuellt därför ha bara en motor på tre olika grejer då kan man inte göra två saker samtidigt. Samtidigt man kan ju vänta också...

IP10- I så fall laddningsstation, det känns lite komplicerat att flytta motorn mellan dem om man nu vill använda båda två samtidigt. Alltså på morgonen då sätter jag igång allting direkt liksom och går sedan och sätter mig och äter frukost. Utan sladd känns bra, för i detta hem finns det bara två uttag vid där vi har produkterna så då får man hålla på och ändra.

IP11- Oj, vad jobbigt. Hellre då gemensam laddning så man laddar upp dem och sedan kan ha dem med sig.

IP12- en gemensam motor, ja. Jag tror det andra hade blivit för stort. men motorn skulle jag nog gilla då, nackdelen är ju att man inte kan använda dem samtidigt en nu använder jag ju dem väldigt sällan samtidigt alla tre..

IP13- ja fast vet inte om man kan använda det samtidigt då, om jag skulle bli övertygad om att det är bättre så kanske,

IP14- om det är för att spara energi så

IP15- om man köper en hel serie kanske då kan man ta fram produkterna och bara sätta de på platan men då måste den vara snygg också. för min del som har grejerna framme är det inte jätte relevant men för andra skulle det kunna vara bra, då slipper man sladdar och det med men jag har ju allt framme så det spelar ingen roll för mig. jag orkar inte gå in i skåpet och hämta vattenkokaren varje gång

Q33: Kan man tänka sig en produkt som gör allt? eller kombinationer av vissa?

IP1- Ja lätt, jag gillar sånt. Slipper man att det tar plats. Jag undrar hur den hade sett ut. Det hade jag lätt köpt. Lite skryt att ha en sån hemma! Det hade varit nice.

IP2- vattenkokare kaffekokare skulle vara intressant men ska vara snyggt, brödrost känns dåligt byt ut den

IP3- ja det är bra med funktioner men beror på om man kan göra det samtidigt, om de är på ett smidigt sätt, beror på vad man behöver,

IP4- känns onödigt

IP5- nej det tycker jag inte, bättre med en sak för dess funktion

IP6- ja det hade varit kul

IP7- Nej jag tror inte det. Jag är ju inte intresserad av kaffekokare, så nä.

IP8- ja, alltså, jag börjar bara tänka hur den skulle se ut, haha. Men om det fanns hade jag definitivt kunnat tänka mig den. Vattenkokare och kaffekokare måste ju vara lättare att kombinera än att kombinera in en brödrost också. Jag bara tänker mig att man får en blöt skiva rostat bröd. Man slipper ju ha framme tre grejer, även om det blir en större grej. Den hade kanske inte behövt vara så stor egentligen.

IP9- Ja, det skulle jag kunna tänka mig.

IP10- Ja, bara man inte måste göra allting samtidigt.

IP11- Ja, det hade inte varit helt fel kan jag säga.

IP12- kaffekokare och vattenkokare kan jag tänka mig men brödrosten har jag svårt att se inbakad, känn som det blivit en så stor produkt att flytta runt på.

IP13- om det skulle vara mindre utrymme, om den blir större så nej, om funktionen av ingen av dem blir sämre

IP14- kan inte se det framför mig, men om det fanns

IP15- ja det hade varit fräckt men då får den vara snygg så den kan stå framme och inte ta onödig plats, kaffekokare och vattenkokare känns som det är mer möjligt, men vattnet får inte börja smaka kaffe isf

Maintenance/repair

Q37: Hur ofta och hur rengör du din kaffekokare?

IP1- Presson diskar man efter varje gång. Kaffefilter behållaren diskar man inte efter varje gång, men termosens gör man. Brukar man ju kunna ta isär delar och diskar och man ser att det är ok att diska.

IP2- varje gång rengör jag. ja behöver inte rengöra så mycket mer för underhållning av damm, vissa delar plockar jag ut typ mjölkskummaren, sköljer av det och kaffehållare, vattenkokare torkas av med trasa, aldrig på insidan, brödrost tömmer man bara

IP3- sällan, 1 ggn var 3e månad, men aldrig bra sköljer bara ur den. ofta, diskar ur vattenbehållaren

IP4- Rengör varje gång den används. diskar ur kannan bara, varje gång vi använder den och håller ut det gamla kaffet, blir ofta mycket över, halv kopp-1kopp, vana att koka för mycket

IP5- Rengör sällan, skulle behövas mer. det är ett problemområde, det enda jag gör är att diska ur kannan, nån gång har jag kalkat av den men väldigt sällan, känns ändå hygienisk

IP6- -

IP7- -

IP8- Jag diskar ju kaffekannan...

IP9- 1ggr i månaden tar jag avkalkningsmedel

IP10- Rengör på mitt sätt en gång i månaden. Kör igenom den med bara vatten och tvättar kaffefiltersgrejen.

IP11- 1 gång i månaden, avkalkar och torkar av det jag kan.

IP12- Aldrig, diskar ur kannan ibland och torkar av på utsidan om det är kaffestänk men det är utan regelbundenhet

IP13- ordentligt en gång i halvåret typ annars sköljer av den. Hela kaffekokaren med ättika ett internet recept typ avkalkning 1 gång i halv året diska en gång i veckan

IP14- varannan vecka kanske, de blir inte så smutsig känns det som

IP15- -

Q38: Hur ofta och hur rengör du din vattenkokare?

IP1- Sköljer man väl ur och så, tänker att den blir ren när det kokar upp. Har aldrig tänkt på att rengöra den. Det kokar ju, men rengör man den annars? Gå ner där med diskborste, materialet i botten är lite metalligare, man vill inte vara där och peta. Har ju inte diskat den direkt så, torkar av den med trasa om den ser lite dammig ut. Elektronik och vatten man är ju försiktig, vill inte att något ska gå sönder

IP2- Rengör ibland, behövs ej.

IP3- 1 gång har jag rengjort gjort det i London. nej, skulle göra det om jag hade en egen

IP4- -

IP5- -

IP6- Sköljer varje gång jag använder den, torkar, 2 ggr i mån. sköljer bara ur den i rinnande vatten och dammtorkar av den när jag städar

IP7- Rengör varje dag, diskar av bara ca 1 gång månad. "varje-dag-rengöring" är det bara att jag sköljer ur den, och sen någon gång då och då så diskar jag utsidan med lite diskmedel.

IP8- mamma....

IP9- Jag har kalkat av en gång på 10 år, finns speciella för vattenkokare

IP10- Typ, aldrig, typ en gång om året?

IP11- varannan månad, kalkar av, det är den rengöring jag gör. Blir den kladdig torkar jag ju när jag ser det.

IP12- Den går ju inte att sänka ner i vatten, typ torka av om den blir smutsigt men det är väldigt sällan.

IP13- -

IP14- Bara med diskmedel och vatten, med en disksvamp

IP15- Rengör ofta, var tredje gång, men spola i vatten och hälla ut varje gång. sköljer ur den med vatten

Q39: Hur ofta och hur rengör du din brödrost?

IP1- Rengör inte ofta, 2gångar år? att man torkar av och skakar ur. Grundlig rengöring. Den vänder jag upp och ner på och skakar. Men det är ju också prylar då är man rädd att något lossnar och går sönder. Smulorna hamnar ju aldrig bara i luckan i botten, har de testat den själva? vem tror att de hamnar där?

IP2- Rengör så sällan jag kan.

IP3- Rengör varje gång den används. smulor- vänder på den upp och ner, bättre med en lucka att tömma snabbt och enkel- går inte att diska,

IP4- Rengör sällan. Skakar ur den.

IP5- Rengör oftare, men bara det lilla jag gör. torkar den och skakar ut smulorna

IP6- Rengör 2ggr i mån. dammtorkar av den när jag städar

IP7- Varje gång jag använder den tömmer jag ut smulorna. Den rengör jag nog faktiskt inte. Jag vänder upp och ner på den och skakar ut smulorna. Den kan man ju inte rengöra?

IP8- Rengör när det börjar lukta bränt.. någon gång i månaden kanske. Ibland vänder jag upp och ner på brödrosten och skakar lite...

IP9- Det vet jag inte, för jag har haft den i tolv år och aldrig rengjort den.. Jo ibland tömmer jag ut smulor, men bara när jag tänker på det, det är sällan

IP10- Aldrig, skakar ur smulorna, det är typ det jag gör men inte annars.

IP11- Hur rengör man den, tömmer ut brödsmlorna och torkar av gör jag efter varje användning.

IP12- Man vill få ut smulorna och så för det kan börja lukta väldigt bränt och äckligt, men jag gör ju inte det ofta, inte varje gång jag använt den, långt ifrån. Med skivan undertill.

IP13- Rengör inte ofta. smul -diskar den utdragbara grejen i gallret så brukar jag skaka eller petar bort det

IP14- Rengör inte tillräckligt ofta, engång i månaden. har nog aldrig gjort det, tar bara bort skivan med smulor, och torkar av den med trasor

IP15- Rengör vart annat år. brödrost tar ut facket för smulor om det finns, annars skaka den och vända upp och ner

Q48: Skulle du kunna tänka dig att använda en produkt som varit någon annans/ärvd?

IP1- Min gamla kaffekokare var min mammas gamla för hon bytte ut. I början av studentlivet. Det beror på vilket skick produkten är i, man vill helst veta vem som haft den innan, jag hade inte gått och köpt på loppis... vänner och familj. Smådelar känns som det kan finnas ingrott smutts, ugnform då ser man varenda detalj och då kan jag rengöra jättenoga! En sån produkt får man inte ren på varje ställe....

IP2- nej, ärvd möjligen

IP3- ja om det är familjemedlem eller kompis men inte blocket, för vem har använt den, det kan vara äckligt

IP4- ärvd ja, men inte blocket inte den här typen är för personliga

IP5- ja

IP6- ja, ärvd

IP7- Ja

IP8- Ja, vi köper ju grejer second hand.

IP9- Ja, det gör jag redan så, ja, då kan jag inte säga nej.

IP10- Ja, det skulle jag kunna göra.

IP11- Ja.

IP12- Ja

IP13- blocket om jag får se den innan

IP14- ja absolut alla mina produkter är det

IP15- ärvd ja men inte blocket det känns äckligt

Appendix III

User tests, planning and results

Kaffekokare

Innan testet:

Ger uppgift

Testet börjar:

Användaren kokar kaffe

Vi filmar händelseförloppet

Vi skriver och registrerar mängden vatten i kannan som mäts upp

Vi skriver och registrerar mängden vatten som hålls upp i kaffebryggaren

Vi registrerar mängden kaffe som hålls upp

Användaren får återställa kaffekokaren så den är fräsch till nästa person

Vi registrerar hur den rengörs

Uppgift till användaren:

Användaren får i uppgift att sätta på timern på 4 h och ställa in aromstyrka medel.

Användaren får kryssa i ett emotion wheel för att för att förklara deras känslor kring användningen av produkten

Efter testet får användaren:

Välja på skalan vilken styrka kaffet fick:

Svagt

Starkt

Markera antal koppar som faktiskt bryggdes:

1 2 3 4 5 6 7 8 9 10

Markera på en skala hur nöjd användaren vart med resultatet på kaffet

Inte alls nöjd

Mycket nöjd

Kryssa i ett semantic word scale

Vattenkokare

Innan testet:

Ger uppgift

Under testet:

Användaren får koka vatten

Vi filmar händelseförloppet

Vi ser hur de använder mätinstrumentet

Vi ser om de reflekterar över funktionerna

Vi registrerar mängden vatten som är kvar i kannan

De får servera te i det antal koppar som bestämts innan.

Uppgift: Du ska mäta upp fyra koppar kaffe men vattnet ska inte koka, vi skulle vilja att du ställer in så att vattenkokaren endast värmer det till 80 grader. När du gjort detta skulle vi vilja att du ställer in så att vattenkokaren håller vattnet varmt i tjugo minuter. *(glöm inte att de här måste ha tillgång till manualen om de skulle vilja använda sig av den!)*

Efter testet:

De får fylla i ett Emotion wheel kring hur de upplevde att använda produkten

Användaren får markera antal koppar som bryggdes:

1 2 3 4 5 6 7 8 9 10

Till sist får de fylla i en semantic word scale.

Brödrost

Innan testet:

Får uppgift

Under testet:

Vi registrerar hur de ställer in

Vi registrerar användning

Vi registrerar resultatet

Uppgift: Värm upp en redan rostad macka *(testar om de använder funktioner rät då det finns specifik knapp för detta eller om de bara rostar om brödet igen på lägre inställning)*

Efter testet:

De får fylla i ett Emotion wheel kring hur de upplevde att använda produkten

Hur nöjd är du med resultatet i förhållande till ditt första val?

Inte alls nöjd

Mycket nöjd

Till sist får de fylla i en semantic word scale.

Kaffekokare

Använder måttenhet på kannan? Ja Nej

Använder måttenhet på bryggaren? Ja Nej

Reflekterar över styrkan på kaffet? Ja Nej

Interagerar med displayen? Ja Nej

Använder måttskopa för kaffet? Ja Nej

Reflekterar över de markerade kaffeskoporna på bryggaren?
Ja Nej

Använder inställningar?	Ja	Nej
Hittar on/off knappen?	Ja	Nej
Använder manualen?	Ja	Nej
Tar ut hela filterbehållaren?	Ja	Nej
Reflekterar över slängning av kaffefiltret?	Ja	Nej
Sköljer ur kannan?	Ja	Nej
Sköljer ur kaffefiltret?	Ja	Nej
Drar ut kontakt vid återställning?	Ja	Nej
Är du nöjd med resultatet på kaffet?	Ja	Nej
Hur mycket kaffe är det kvar i kannan?		

Övriga observationer:

Vattenkokare

Använder måttenhet på kannan?	Ja	Nej
Använder ögomått?	Ja	Nej
Höftar mängd vatten?	Ja	Nej
Interagerar med displayen?	Ja	Nej
Använder inställningar?	Ja	Nej
Använder manualen?	Ja	Nej
Sköljer ur kannan?	Ja	Nej
Använder extra funktioner?	Ja	Nej
Drar ut kontakt vid återställning?	Ja	Nej
Hur mycket vatten är det kvar efter de koppar vi “beställt”?		

Övriga observationer:

Brödrost

Använder inställningar?	Ja	Nej
Använder manualen?	Ja	Nej
Använder stoppknappen?	Ja	Nej
Skakar ur smulorna?	Ja	Nej
Använder smulbrickan för rengöring?	Ja	Nej
Använder extra funktioner?	Ja	Nej
Använder lift funktion?	Ja	Nej
Får rosta om?	Ja	Nej
Får slänga brödet?	Ja	Nej
Ok rostat bröd?	Ja	Nej
Drar ut kontakt vid återställning?	Ja	Nej
Är du nöjd med resultatet på rostningen?	Ja	Nej

Övriga observationer:

User tests, results

IP1	IP2	IP3	IP4	IP5	IP6	IP7
Female	Female	Male	Male	Female	Male	Male

IP1

Kaffekokare övrigt:

Spolar vatten innan så det blir kallt innan hon fyller kannan.
Håller ut överblivet vatten efter att ha mätt på bryggarens måttangivelses- använde ej dem på kannan.
Knapparna upplevs plastiga
Det var inget skönt motstånd i kannan när man tog ut den från bryggaren

Testet: trycker på program - händer inget - ställer in klockan istället men fårtår att det blir fel- förstår ej varför det inte funkar- försöker använda manualen - följer alla steg men funkar ej ändå - lyckas inte- vi får förklara problemet.

Vattenkokare övrigt:

fyller i mer vatten än vad som egentligen behövs - bättre med för mycket
ingen feedback på start upplevs som jobbigt - förstår mha färgen men displayen säger 0.
reflekterar över att den blåa färgen upplevs kallare än den gröna (fel ordning på dem)
den upplevs som snabbt
fundersam på om man måste stänga av den

kommentarer på displayen:
kanske bra att kunna ha koll på temp - men känns onödigt - gillar enkelheten

testet: begärt 4 koppar, mäter upp - blir för mycket- håller ut- blir för lite- håller på mer.
förstår ej hur keep warm funktionen funkar- displayens siffror börjar blinka- vad betyder det? irriterande att den småputtrar när den ska hålla 80 grader

låter vattnat vara kvar i kannan vid återställning

brödrost övrigt:

dålig kvalitet på "spaken"
tar tid innan den blir varm
testet: värma igen- rostar igen och trycker på stopp ist för uppvärmningsfunktionen

IP2

kaffekokare övrigt:

osäker på om den är igång

Test: läser manualen- tar tid att hitta- lite osäker ändå om det är rätt- ser ej skillnaden på klockan och timern - får knappa runt mycket iom att den inte går att knappa ner igen för tid- märker ej att den växlar tillbaka till klocka om man är lite långsam

vattenkokare övrigt:

tröck på start för att få upp locket
brukar aldrig läsa manualen
vet ej om den är igång
dumt att knapparna sitter där man håller på handtaget
har hemma en lättare variant
bör ha en annan färg på knapparna när den är igång
tycker inte om färg förändringen när den är igång
kokar hemma mest för mat

test: läser manual- läser av på skalan
förstår ej keep warm knappen

övrigt- keep warm 80 håller över 80.

Brödrost övrigt:

Håller koll på tonen på brödet

test: knappen lyser ej- använder manualen

IP3

kaffekokare:

är osäker på vilken av skalorna som är en kopp
har i mer kaffe än vad som är rekommenderat
kaffebyggaren känns ok men är för hög
bra med en timer men fattar inte att det är det den är

test: styrkan symbolerna är inte samma på display som på byggaren
drygt att man inte kan gå bakåt i tidsinställningarna
måste läsa manualen för timerinställning

vattenkokare:

får böja sig för att se skalan när vattnet fylls på
färgen känns onödigt tillsammans med displayen, känns också plastig
tråkigt att man inte kunde öppna den med en hand
den piper mycket

brödrost:

grovt och ljusst bröd ska rostas olika → vill rosta dem separat
får hålla koll på brödet trots inställning
har koll på rödheten i trådarna
osäker på när den ska poppa upp → trycker på stopp
går mer på syn än på inställningar

IP4

Kaffekokare:

håller ut extra vatten från kannan
osäker på om on/off innebär ström och el eller om det är för att köra igång maskinen
satte på on/off knappen men osäker om den var på även om knappen lös
den upplevdes pedagogisk för att aldrig ha använt en sådan produkt
förstår ej vad bönorna betyder

Test:

osäker
håller inne program för att försöka aktivera
osäker på om det är en timer på 4 h eller om det är kl 4.00

använder manualen men är fortfarande osäker på om det är rätt eller fel
vill att timern ska räkna ner
det var svårt att förstå hur man gör
vill kunna bekräfta program på ett annat sätt

vattenkokare:

sätter på värme grader och keepwarm men är osäker på om den är igång → sätter ej på den
väntar och ser om något händer
är inte nöjd även när den börjar låta lite → blir nöjd när temperaturen börjar förändras
osäker när det står 0 så länge
trodde den skulle vara enklare att hantera än kaffekokaren
den är för komplicerad
borde finnas en grundinställning (förstår inte att det finns)
satte på 90 grader men den går till 100 ändå..

test:

förstår vad knappen betyder
skvätter när man öppnar locket vilket inte är så bra om det är varmt vatten
får ej keepwarm att lysa för det sätts på i fel ordning → manual
väntar och ser vad som händer
kokar vanligtvis om gammalt vatten som blir kvar

brödrost:

är alltid svårt med en ny rost att förstå värmegraden
satte på reheat- trodde det var extra värme
tryckte på stopp och ställer om
vaktar mackorna- håller koll
rosten rostar ej hela mackan fast det är en standardmacka

IP5

Kaffekokare:

använder manualen vid test

vattenkokare:

Manualen används för att förstå om den är på
kändes svår att använda överlag

börjar pipa- varför?

IP6

Kaffekokare:

inte mycket utrymme att hålla i
håller ut det sista vattnat efter att ha mätt
upp på bryggaren
en mer skopa än antalet koppar vatten
osäker på om den är på
får ej öppna locket och kolla
den är rätt tyst

test:

vill ha nedräkning på timern
vill se att programmet startar
vill klara det utan manual

vattenkokare:

svår att öppna
inte bra med kondensen
osäker på vad pipandet betyder
locket förhindrar att se skalan samtidigt
som man håller i vatten
dåligt med feedback - kollar manualen

brödrost:

står och väntar- har koll på färgen på
brödet

försöker kolla ner i den
är siffrorna minuter eller skala
hade lagt den ovan på om jag ville värma
upp den

IP7

kaffekokare:

osäker om om den är på
test: ställer in klockan ist för taimer
testar hålla in fler knappar samtidigt -
kollar on/off

vattenkokare:

locket är svårt att få upp
osäker på om den är på- 0 visas samtidigt
som färg säger emot varandra, vatten är
inte 0 grader i kranen
bra med extra funktioner men måste vara
tydligt
on/off är fel- betyder inte samma sak som
förr- on innebär aktivera och därefter gör
man inställningar
Grön känns som det är färdigt fast det är
den första färgen.
låter vattnat stå när det är klart kokar om
det nästa gång
en timer som drar mycket ström känns
osäkert
symboler onödigt- skriv ut namnet ist.

brödrost:

test- osäker på om det är rätt - trycker på
stopp och ändrar till defrost. hittar först
inte stopp
jag kollar mycket på vad som händer, vill
ha en teknisk förklaring på det- vad
innebär defrost....?

Appendix V

Geneva emotion wheel

Example of Geneva Emotion Wheel

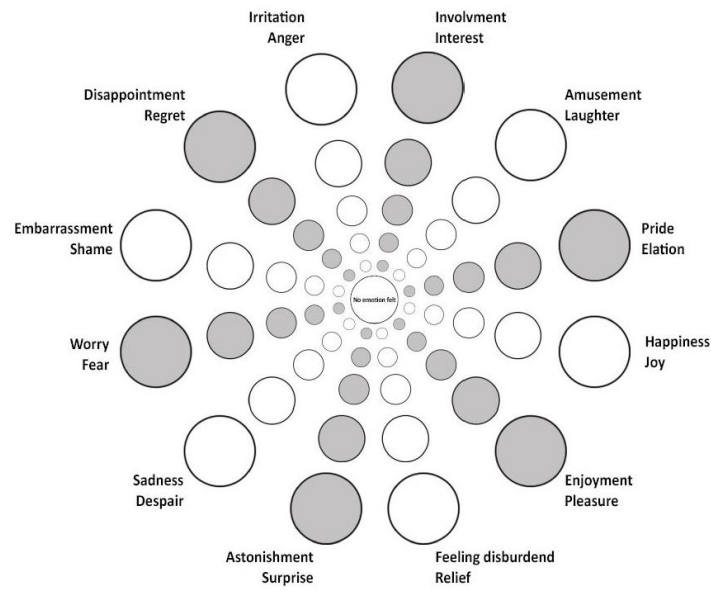

Results of Geneva Emotion Wheel, User studies, Coffee maker

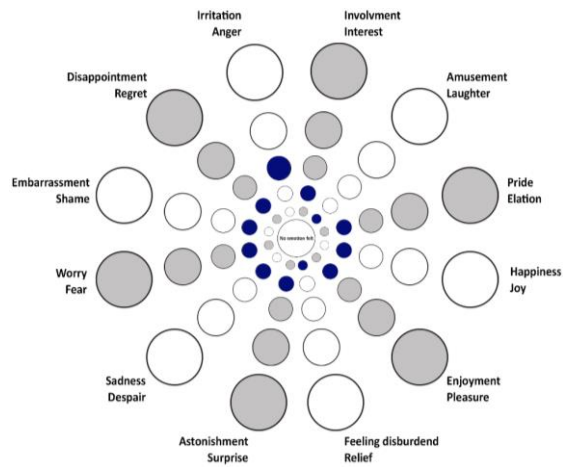

Results of Geneva Emotion Wheel, User studies, Kettle

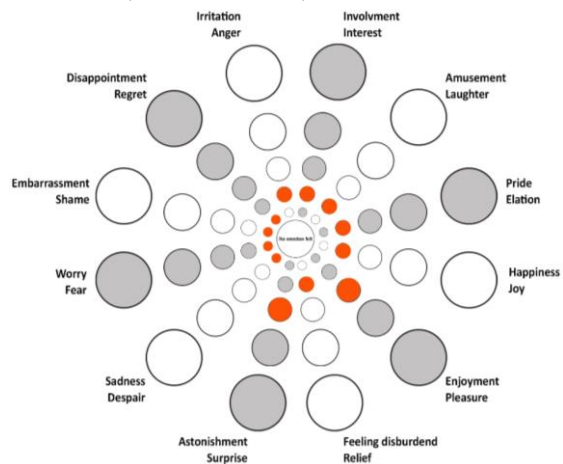

Results of Geneva Emotion Wheel, User studies, Toaster

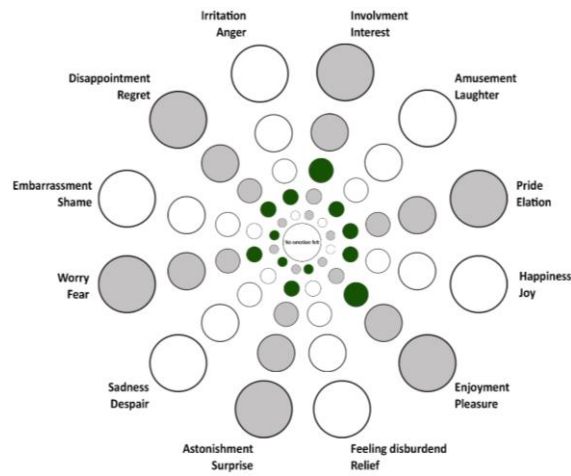

Results of Geneva Emotion Wheel, Evaluation, Coffee maker

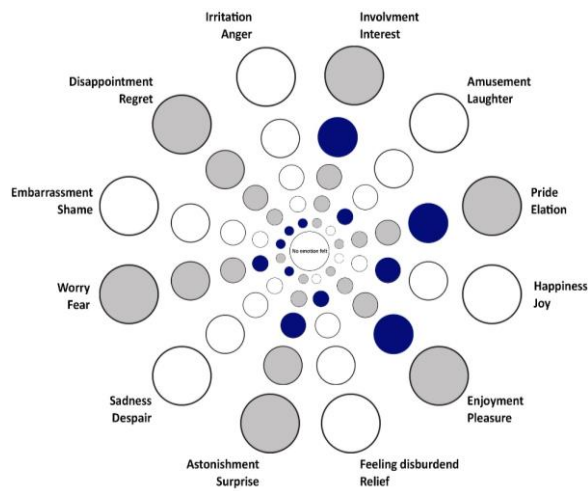

Results of Geneva Emotion Wheel, Evaluation, Kettle

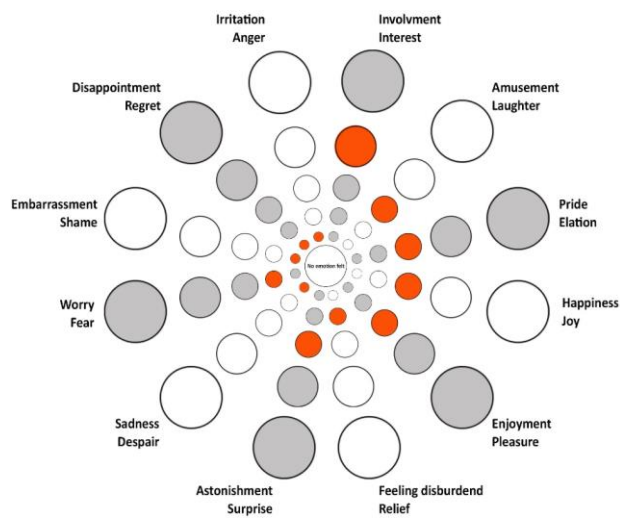

Results of Geneva Emotion Wheel, Evaluation, Toaster

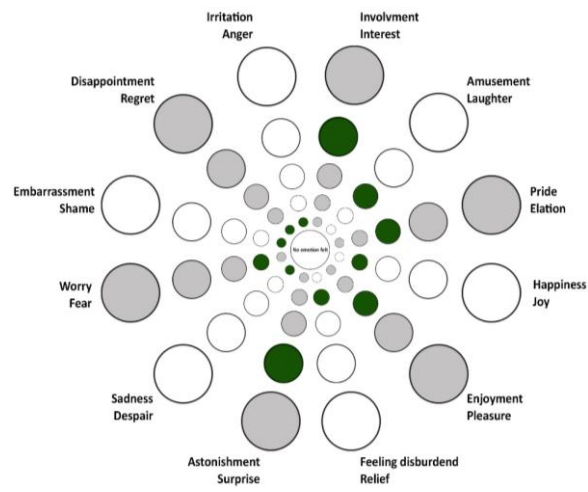

Appendix VI

Semantic word scale

Example of Semantic word scale

SEMANTIC WORD SCALE

Stressful	<input type="radio"/>	<input type="radio"/>	<input type="radio"/>	<input type="radio"/>	<input type="radio"/>	Calm
Fast	<input type="radio"/>	<input type="radio"/>	<input type="radio"/>	<input type="radio"/>	<input type="radio"/>	Slow
Good looking	<input type="radio"/>	<input type="radio"/>	<input type="radio"/>	<input type="radio"/>	<input type="radio"/>	Ugly
Robust	<input type="radio"/>	<input type="radio"/>	<input type="radio"/>	<input type="radio"/>	<input type="radio"/>	Fragile
Stable	<input type="radio"/>	<input type="radio"/>	<input type="radio"/>	<input type="radio"/>	<input type="radio"/>	Unstable
Trustworthy	<input type="radio"/>	<input type="radio"/>	<input type="radio"/>	<input type="radio"/>	<input type="radio"/>	Unreliable
Safe	<input type="radio"/>	<input type="radio"/>	<input type="radio"/>	<input type="radio"/>	<input type="radio"/>	Hazardous
Easy	<input type="radio"/>	<input type="radio"/>	<input type="radio"/>	<input type="radio"/>	<input type="radio"/>	Bothersome
Space effective	<input type="radio"/>	<input type="radio"/>	<input type="radio"/>	<input type="radio"/>	<input type="radio"/>	Clumsy
Durable	<input type="radio"/>	<input type="radio"/>	<input type="radio"/>	<input type="radio"/>	<input type="radio"/>	Untenable
Irretating	<input type="radio"/>	<input type="radio"/>	<input type="radio"/>	<input type="radio"/>	<input type="radio"/>	Inspiering

Result of Semantic word scale, User studies, Coffee maker

SEMANTIC WORD SCALE

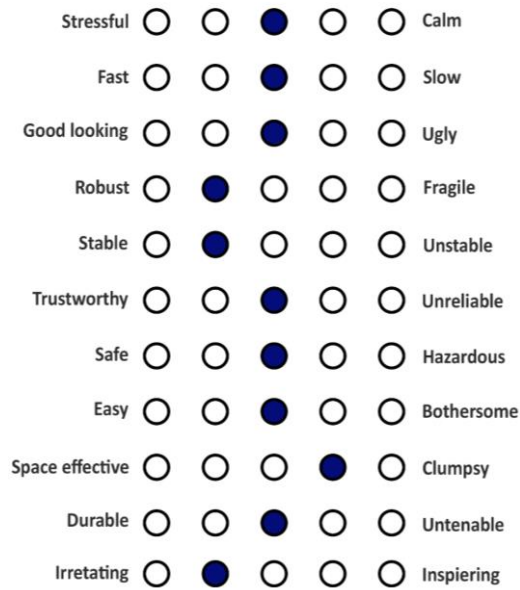

Result of Semantic word scale, User studies, Kettle

SEMANTIC WORD SCALE



Result of Semantic word scale, User studies, Toaster

SEMANTIC WORD SCALE



Result of Semantic word scale, Evaluation, Coffee maker

SEMANTIC WORD SCALE

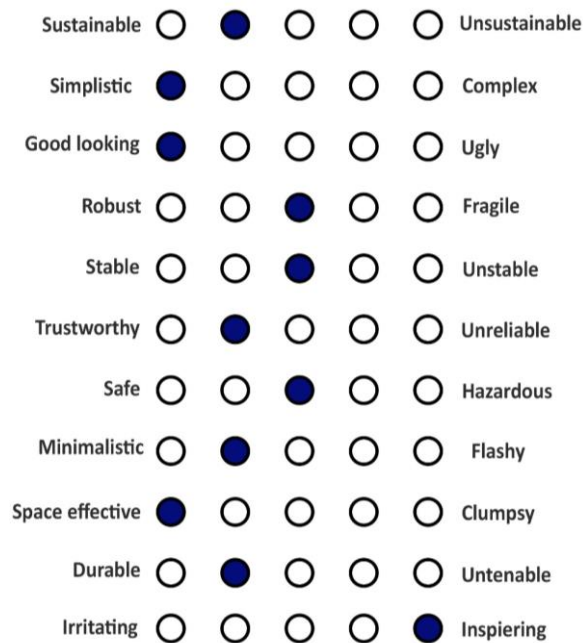

Result of Semantic word scale, Evaluation, Kettle

SEMANTIC WORD SCALE

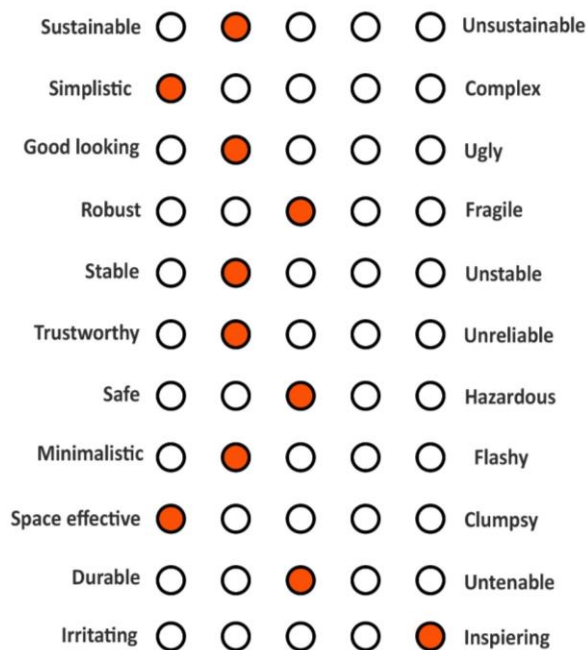

Result of Semantic word scale, Evaluation, Toaster

SEMANTIC WORD SCALE

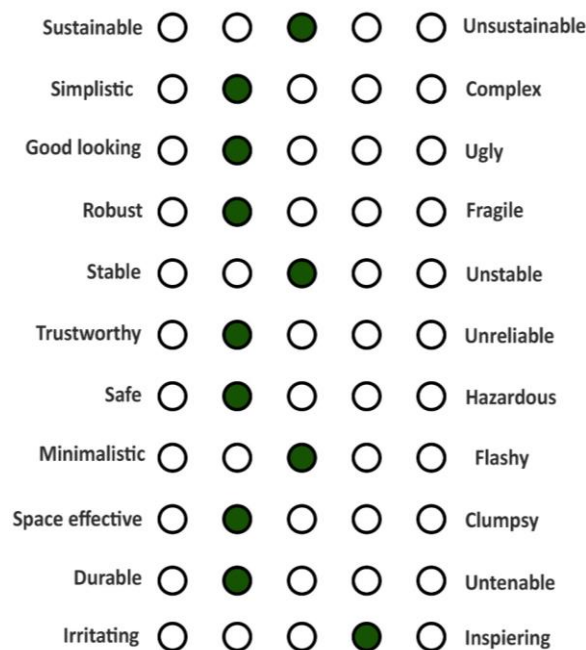

Appendix VII

What a designer can change

Coffee maker	Today	Possible changes
Supported motives: Why an artefact is designed in the first place	To enable making brewed coffee in a simple, fast and easy way	
- Which activity should be enabled?	Brew coffee	Save coffee that is left
- Which motives should the artefact support?	Easy use Inviting	Sustainable behaviour Disassembly Repair
- Which needs are relevant to address?	Easy way of making good coffee daily/occasionally Fast Good looking Easy to fill up with water and coffee Clear scale on both pot and side Good cord length Durable Flexible in the amount of coffee that can be brewed Space effective Turn itself off after certain amount of time Brew-time indicator	Multifunctions Less functions Support cleaning The scale should help the users to not brew too much
Artefact type: What is to be designed	Something that makes brewed coffee	
- In what way should the motive be supported?	Electric coffeemaker	
- What artefact can mediate the activity?	Electric coffeemaker	A electric coffeemaker with less environmental impact
Operative functions: What should be designed, in more detail than artefact type	An electric coffeemaker that enables the user to make brewed in a certain amount of time using coffee, water, electricity and filter.	
Operating concepts: How to deliver the main functions	An electric heating system that makes the water warm/boil A transportation system for the water to the filter A system that mixes water and milled coffee A system that separates the milled coffee from the pot	An alternative heating system An alternative transportation system An alternative mixing system An alternative separating system
- What types and Amount of resources needed?	Water Electricity Milled coffee	Minimize use of water Minimize use of electricity Reusable coffee filter

	Coffee filter Human effort	
- Which type and amount of pollution (waste) created	Energy Heat Leftover coffee Filter	Take advantage of the leftovers Take advantage of the extra heat Reduce the amount of functions Reduce the amount of parts
Practical functions: Determine what the user should be able to do with the artefact	Fill the coffee Fill water Turn it on/off Pour coffee Aroma function Programmable timer Auto-off Removable filter basket Anti drip function Small/big cups indicator on pot and coffee maker	Take advantage of the leftovers Adjust the right amount of coffee needed Recycle Eco feedback Identify functions not being used (Potentially eliminate them?)
- What does the user need to be able to benefit fully from the main functionality?	Fill water Remove the pot Open the lid Place and remove the coffee filter Remove and connect the outlet Turn it on/off Fill with coffee Heat water Keep water warm Enable the water and coffee to be mixed Movable Enable pouring from the pot Read the scale	
- What does the user need for the artefact to fit into the activity?	Coffee filter Water Coffee Energy outlet Match between functions and user needs	
Interactive functions: users possibilities for interacting with the artefact		
- How Should the user interact with and control the artefact?	Touch Sound Light Display Signs Colour/ contrast indications	
- How should the user be given access to the functions?	Buttons Handles Lid Moveable filter basket	

	Transparent scale (revealing the water) Display	
Communicative functions: Includes both semantic and syntactic functions		
Semantic- describe purpose and mode of operation; express properties, exhort reactions; and identify a product, its origin, kinship, location, nature or category		
Syntactic - include the ordering of Product form, and how to compose perceptual element to form a whole		
- How should the user perceive the artefact	Easy to use Robust Functional Appealing Inviting Safe	Environmental friendly Durable
- How do I want the user to feel when using the artefact?	Calm Interest Involvement Pride Pleasure Happyness High control	Engaged/ Committed/ Dedicated

Kettel	Today	Possible changes
Supported motives: Why an artefact is designed in the first place	To heat up and boil water in a fast and easy way	
- Which activity should be enabled	Use hot water for food or drink	Save water that is left
- Which motives should the artefact support?	Easy to use Inviting	Sustainable behaviour Disassembly Repair
- Which needs are relevant to address?	Enable making hot boiling water fast Regulate the water temperature Fast Clear scale Easy to read the scale Good looking Flexible Effective Flexible in the amount of cups Durable Feedback when using functions	No/low minimum level Flexible cord Multifunctions Less functions Support cleaning The scale should help the users to not boil too much
Artefact type: What is to be designed	Something that make water boil	
- In what way should the motive be supported?	Electric kettle	
- What artefact can mediate the activity?	Electric kettle	A kettle with less environmental impact
Operative functions: What should be designed, in more detail than artefact type	An electric kettle that enables the user to boil water in a certain amount of time using water and electricity	
Operating concepts: How to deliver the main functions	An electric heating system that makes the water warm/boil	Alternative heating system
- What types and Amount of resources needed	Water Electricity Human effort	Minimize the use of water Minimize the use of energy
- Which type and amount of pollution created	Energy Heat	Take advantage of the leftovers Take advantage of the extra heat Less functions Reduce the amount of parts
Practical functions: Determine what the user should be able to do with the artefact	Fill with water Pour water Turn on/off Read the scale Colour indication (temperature) Temperature regulator	Save the water not used Adjust the right amount of water needed Recycle Eco feedback

	Keep warm function Pipe filter Easy placement Flexible placement Easy lid opening Removable scale filter	Identify functions not being used (Potentially eliminate them?)
- What does the user need to be able to benefit fully from the main functionality?	Fill water Remove the pot Open the lid Place and remove the filter Remove and connect the outlet Turn it on/off Fill with water Heat water Movable Enable pouring from the pot Read the scale	
- What does the user need for the artefact to fit into the activity?	Water Energy outlet Match between functions and user needs	
Interactive functions: users' possibilities for interacting with the artefact		
- How Should the user interact with and control the artefact?	Touch Sound Light Display Signs Colour/ contrast indications	
- How should the user be given access to the functions?	Buttons Handles Lid Transparent scale (revealing the water) Display	
Communicative functions: Includes both semantic and syntactic functions		
Semantic- describe purpose and mode of operation; express properties, exhort reactions; and identify a product, its origin, kinship, location, nature or category		
Syntactic - include the ordering of Product form, and how to compose perceptual element to form a whole		
- How should the user perceive the artefact	Easy to use Robust Functional Appealing	Environmental friendly Durable

	Inviting Safe Flexible	
- How do I want the user to feel when using the artefact?	Calm Interest Involvement Pride Pleasure Happyness High control	Engaged/ Committed/ Dedicated

Toaster	Today	Possible changes
Supported motives: Why an artefact is designed in the first place	To be able to eat toasted bread in a simple and fast way	
- Which activity should be enabled	Heat and toast bread daily/occasionally	
- Which motives should the artefact support?	Easy use Inviting	Sustainable behaviour Disassembly Repair
- Which needs are relevant to address?	Toasted bread Easy to use the scale Good looking Clear functions Easy to clean Easy to remove the bread Time indicator Small Fast Good cord length See that it is on Toast different types of bread Easy to regulate the temperature	Flexible cord Multifunctions Less functions Support cleaning The scale should help the users to not toast too much/less
Artefact type: What is to be designed	Something that makes bread toasted	
- In what way should the motive be supported?	Electric toaster	
- What artefact can mediate the activity?	Electric toaster	A toaster with less environmental impact
Operative functions: What should be designed, in more detail than artefact type		
Operating concepts: How to deliver the main functions		An alternative heating system An alternative separating system
- What types and Amount of resources needed	Electricity Heat Human effort Bread	Minimize the amount of energy used
- Which type and amount of pollution created	Energy Organic waste	Minimize organic waste Take advantage of the leftovers Take advantage of the extra heat Less functions Reduce the amount of parts

<p>Practical functions: Determine what the user should be able to do with the artefact</p>	<ul style="list-style-type: none"> Put in 1-2 slices of bread Pick up bread Turn on/off Regulate the scale Temperature regulator Easy placement Flexible placement Defrost Stop button Reheat function Lift system Removable crumb tray 	<ul style="list-style-type: none"> Adjust the right amount of toasting needed Recycle Eco feedback Identify functions not being used (Potentially eliminate them?) Not heating the whole toaster when only toasting one slice of bread.
<ul style="list-style-type: none"> - What does the user need to be able to benefit fully from the main functionality? 	<ul style="list-style-type: none"> Fill with bread Remove and connect the outlet Turn it on/off Fill with water Heat bread Movable Read the scale 	
<ul style="list-style-type: none"> - What does the user need for the artefact to fit into the activity? 	<ul style="list-style-type: none"> Bread Energy outlet Match between functions and user needs 	
<p>Interactive functions: users' possibilities for interacting with the artefact</p>		
<ul style="list-style-type: none"> - How Should the user interact with and control the artefact? 	<ul style="list-style-type: none"> Touch Sound Light Display Signs Colour/ contrast indications 	
<ul style="list-style-type: none"> - How should the user be given access to the functions? 	<ul style="list-style-type: none"> Buttons Handles Temperature regulating wheel Pockets for bread 	
<p>Communicative functions: Includes both semantic and syntactic functions</p>		
<p>Semantic- describe purpose and mode of operation; express properties, exhort reactions; and identify a product, its origin, kinship, location, nature or category</p>		
<p>Syntactic - include the ordering of Product form, and how to compose perceptual element to form a whole</p>		

<p>- How should the user perceive the artefact</p>	<p>Easy to use Robust Functional Appealing Inviting Safe Flexible</p>	<p>Environmental friendly Durable</p>
<p>- How do I want the user to feel when using the artefact?</p>	<p>Calm Interest Involvement Pride Pleasure Happyness High control</p>	<p>Engaged/ Committed/ Dedicated</p>

Appendix VIII

The Guidelines

Design for sustainable behaviour guidelines

This chapter will explain the guidelines developed from the theoretical frame of reference concerning DfSB and describe how these can be applied in the design process.

The chapter is divided into nine different parts named Expressions, Measurement system, Use, Feedback, Motivation, Durability, Energy consumption, End of Life and Disassembly.

The blue sections will describe the different parts and the grey section explains the main guideline. The guidelines is further explained by statements to fulfil when working with the specific guideline. There will also be examples for each guidelines which will be within the framed area.

Expressions

The products should be designed with focus on sustainable design features

This guideline aims to apply sustainability principles on the design to make the product sustainable by giving it design features that have been identified as typical for sustainable products.

To work with this guideline, strive towards fulfilling the following statements:

- Reduce the amount of different materials that the product consists of.
- Reduce the amount of components that the product consists of.
- Apply design for disassembly.
- Reduce the amount of waste that the products produce during use.
- Reduce the amount of energy that the product consumes during use.
- Reduce the amount of energy that the product consumes when on standby.
- The product should consist of materials that are sustainable.
- The product should consist of materials that are perceived as sustainable.
- The user should understand and perceive that the product is sustainable.

Examples:

- Use clear and distinct meetings between different materials.
- Use clear split lines.
- Use good contrasts between materials.
- Avoid cheap plastic parts.
- Use easy and simple shapes.
- Give the product an extra value by being upgradeable and the possibility of having a second life.
- Give the products extra value by enabling for the product to function in different contexts.
- Use expressions of simplicity and minimalism meaning that the product should use few details, have visible functionalities, use few materials, few functions and clean shapes and surfaces.
- Give the product an honest expression, meaning focusing on logicity and functionality.

Measurement system

The user should be encouraged to use the measurement system

This guideline aims to help the users to boil, brew or toast the wanted amount of water/coffee or toasting grade by encouraging use of the measurement system.

To work with this guideline, strive towards fulfilling the following statements:

- The measurement system should be easy to detect.
- The measurement system should be easy to use.
- The measurement system should focus on users different preferences.

- Adopt the measurement system to as many users as possible.

Examples:

- The user should understand the consequences of boiling too much water.
- The configuration of the measurement system should correspond to what the users expects. For example what their mental model of a cup is.
- The placement of the measurement system should be prominent.
- The user should be encouraged to use more than the max/min limits on the measurement system.

Explore alternative ways of designing the measurement system

This guideline aims to investigate other channels than the measurement system to encourage the user to boil only the amount of water or coffee needed.

To work with this guideline, strive towards fulfilling the following statements:

- The measurement system should raise the user's awareness about water consumption.
- The measurement system should motivate the user to boil the right amount of water.

Examples:

- Restrict the user to measure the right amount of water.
- Investigate systems that help the user to measure the right amount of water.
- The measurement system should promote usage of more than the max and min limits.
- The product should give the user the possibility to adapt the system to own preferences.
- Use a complement to the product with similar goals as the measurement system.

The user should have an easy access to the measurement system

This guideline aims to work with the product and the measurement system to enable easy access for the users.

To work with this guideline, strive towards fulfilling the following statements:

- The measurement system should be easily assessable for the user.

Examples:

- The measurement system should be visible for the user.
- The placement of the measurement system should be prominent.

Use

How to interact with the product should be obvious

This guideline aims to work with the product's interaction features to make the user able to understand the product, and to use it in the intended and most efficient way.

To work with this guideline, strive towards fulfilling the following statements:

- Make the interaction with the product obvious.
- Make the users understand the product without difficulties.

Examples:

- Make the symbols clear for the user.
- Use no or few buttons to decrease the risk of confusing the users
- Use no or few buttons to save resources.
- Placing and ordering of functions should be according to cognitive ergonomics to ease the use of the product.

The product should encourage to make use of extra coffee or water

This guideline aims to help the user to make use of the extra amount of coffee or water produced.

To work with this guideline, strive towards fulfilling the following statements:

- Make the user save the excess coffee or water
- Make the user use the excess coffee or water for other things.
- Enable to keep the liquid warm.
- Enable to transport the liquid in its warm state.
- Not consuming more resources.

Examples:

- Incorporate a thermos function
- Incorporate an easy way for the user to bring the excess coffee or water from home

The product should have a flexible interface

This guideline aims to help the user control the product and make it customized for each consumer without using more technology.

To work with this guideline, strive towards fulfilling the following statements:

- Make the product adaptable for many users.
- Make the product upgradeable.

Examples:

- Give the user the possibility to adopt the functions of the products after desire.
- The product should give the user feedback at any time about the products status, such as if the product is on/off, if maintenance is needed, time left etc.
- The product should enable the user to control the products from a distance, for example start a timer or put the product on/off from a distance etc.
- The product should enable the user to get Eco-feedback, such as energy use (daily, weekly or per month).
- The users should have the possibility to choose which functions they need while still keeping the same base products.
- Design the product so that the user do not have to keep too much information about the product in their mind.

Feedback

The product should give behavioural feedback

This guideline aims to give the user behavioural feedback to make them aware of how they act and how it affects sustainability.

To work with this guideline, strive towards fulfilling the following statements:

- Behavioural feedback should be provided through different channels.
- The product should raise the user's awareness about behavioural consequences.
- The feedback should be optional due to many different preferences amongst users.

Examples:

- The product should motivate a regular use of the feedback to increase the chance of users adapting to it and use it in everyday life.
- The feedback should be provided over a longer period of time and preferably on a daily basis.

Motivation

The product should motivate to a more sustainable everyday life

This guideline aims to bring sustainability into the user's everyday life to increase the acceptance of a new product that encourages a sustainable behaviour. The product should be used as a way to motivate people to act more sustainable. The product design should motivate the user to create new sustainable norms, attitudes and values.

To work with this guideline, strive towards fulfilling the following statements:

- The product design should help the user prioritize a sustainable behaviour.
- The product should be time efficient.
- The product should not interfere with existing lifestyles of the users.
- The products should not have a negative impact on the comfort of the user.
- The product should help the users to achieve their goals with the product without being a hinder.

Examples:

- Design features of the product should help the user understand how to use it in a sustainable way.
- The user should be able to get information about sustainability.
- The user should be able to get information about a sustainable behaviour to increase awareness of their behaviours and possible changes.
- A sustainable behaviour should be an obvious choice, so that the users do not have to prioritize sustainability.
- Using the product should not take longer time than using existing products on the market.
- The product should give the user information about sustainable use in relation to the product.
- Design features of the product should make the user want to take care of the product.

The product should encourage to discussion about sustainability

This guideline aims to make the product express sustainability by its design to encourage sustainability discussions.

To work with this guideline, strive towards fulfilling the following statements:

- The product should be eye catching.
- The products should express sustainability features.
- It should be obvious that the product is sustainable.

Examples:

- The choice of materials should be chosen to promote sustainability.
- The use of feedback systems should be used to raise awareness of the user's sustainable behaviour.
- The products should be eye catching when standing together as a collection.

The product should motivate to maintenance

This guideline aims to design the product to help the user extend the product's life by keeping the product in a good condition.

To work with this guideline, strive towards fulfilling the following statements:

- Give feedback concerning cleaning and maintenance.
- The maintenance should increase the product lifetime.
- The product expression should encourage the user to handle the product carefully.

Examples:

- Design the product so that it is easy to clean to increase the chance of maintenance.

- Designing the product so that it is cleaned in the right way, to decrease the risk of the product being worn out earlier than desired.
- The product should have the possibility of giving feedback to the users concerning cleaning and maintenance to increase the chance of users remembering to clean and maintain the product.
- Handling the product with care will decrease the risk of breaking the product.

Durability

The product should be durable

This guideline aims to make products that lasts longer and therefore not become waste too fast. This guideline also aims to meet people's expectations of how long they expect their products to function.

To work with this guideline, strive towards fulfilling the following statements:

- The product should have a long lifetime.
- Make use of parts and components that are still functioning.
- Use materials that are durable.

Examples:

- The product should have a lifetime of more than ten years.
- The product should be able to be repaired if broken.
- Identify which parts and components that break and optimize them to last longer.

The products should have a second hand value

This guideline aims to make the products last longer and give them a second hand value and to give them a second life.

To work with this guideline, strive towards fulfilling the following statements:

- The product should age well.
- Worn out components should be easy to replace.
- The product should have a long lifetime.

Examples:

- The product should age well, meaning that it does not get permanently dirty and consist of materials that get worn out quickly.
- Apply design for disassembly.

Energy consumption

The products should make use of spill energy

This guideline aims to make the product take advantage of energy losses.

To work with this guideline, strive towards fulfilling the following statements:

- Utilize energy losses to give power to other products.
- Reduce running costs for the products.

Examples:

- Make the product take advantage of energy losses from different surrounding products.
- The products should share energy, since all the products transforms electrical energy into heat.

The products should minimize energy consumption

This guideline aims to optimize the performance of the products and raise awareness about energy consumption when the products is used and not used.

To work with this guideline, strive towards fulfilling the following statements:

- The product should be designed to help the users be energy efficient without extra effort.
- The product should be designed to raise awareness about energy consumption.

Examples:

- If making the energy consumption less in the product all users would be using a sustainable behaviour without having to make a conscious decision.

End of life

The company should take responsibility for their products after end of life

This guideline aims to make the company aware of how their products works after the product is not used anymore.

To work with this guideline, strive towards fulfilling the following statements:

- Encourage more people to recycle their products.
- Understand how products age, break down and what the most common problems are.
- Take care of/be aware of worn out or broken products.
- Be aware of the critical parts of the products.

Examples:

- The company should make use of their products after their end of life.
- The product should encourage more people to reuse products and give them a second life.
- The company could use different systems of making the users recycle their old products, such as discounts on returned products.
- The company should understand how their products age, break down and what the most common problems are to help them improve their products and make them more durable and sustainable.
- The company should strive to gain trust from the users by using a well worked out system for recycling.
- The company should take the opportunity to understand what does not work with their products.
- The company should take care of/be aware of worn out or broken products to make sure that they are recycled the right way or fixed and sold on a second hand market.

Disassembly

Design for disassembly should be applied

This guideline aims to design the product with focus on disassembly.

To work with this guideline, strive towards fulfilling the following statements:

- Make it easy to separate both materials and components.
- Make use of components that are still functioning.
- The product should be efficient to disassemble.

Examples:

- Make use of components that are not worn out to give them a second life and reduce unnecessary waste.
- Make the product simple to disassemble to make it easy to repair if broken. This could increase the lifetime of the product and also reduce unnecessary waste.

Green branding guidelines

These guidelines aims to make green branding a part of the company's core values by designing the product focusing on features of green branding.

The product should express sustainability

This guideline aims to make the products express sustainability through the design and material choices without being labelled as green washing.

To work with this guideline, strive towards fulfilling the following statements:

- Use sustainable design features.
- Express sustainability without greenwashing.
- Avoid stereotypical sustainability features that are labelled as green washing.

Example:

- The product should focus on natural forms and materials to express sustainability.
- The product should focus on simplicity and minimalism to expressing sustainability.
- The product should focus on logicity and functionality for an honest expression.
- The product should focus on individuality and diversity meaning that the products should appeal to many users.
- The product should avoid green labelling that the company has developed themselves.

The products should not become waste to fast

This guideline aims to make product life-span longer and decrease the risk of becoming waste to fast. This guideline also aims to make the product's lifecycle more sustainable.

To work with this guideline, strive towards fulfilling the following statements:

- The product should be durable.
- The products should be upgradeable.
- The products should be serviceable.
- The products should be repairable.
- The products should be reusable.
- The products should be recyclable.
- The product should be modular.

Examples:

- The product should be durable by means of good materials and good manufacturing.
- The products should be recyclable to make it possible to reuse the materials in the products.
- The product should be easy to repair and disassemble.
- The design should focus on aesthetic durability.
- Reduce the amount of different parts and components.
- The products should be designed to support the whole product's life cycle.

The product should create extra value

This guideline aims to create extra value for the user and the company when owning the product.

To work with this guideline, strive towards fulfilling the following statements:

- Create value for the users
- Understand the needs of the user.

Examples:

- Investigate what extra value is for the intended target group.
- The products should create value for the user by not only serving as the original use.

- The product can use an alternative shape to challenge stereotypes of what the product looks like to make the user more interested and curious about the product.
- Saving material by reducing, or completely eliminate, components such as buttons and wheels for interacting with the products.
- Use new technology to remind the users when to maintain their products and how to do it in order to make the products last longer.
- The users could benefit from always being able to see if their products are turned on or off and even be able to turn them on/off from a distance.
- The products should use new technology to communicate with the users to be able to give them eco-feedback.
- The user should be able to see and/or understand how the products functions without difficulties.
- The product should only do what it is aimed for and not be given any extra unnecessary functionalities.
- Use new technology to make it possible to upgrade and change function after purchase.
- Use new technology to make able to track their users and their habits around the products.

The product should consist of sustainable materials

This guideline aims to design products that are sustainable in the material choices.

To work with this guideline, strive towards fulfilling the following statements:

- The materials that the product consist of should be advantageously reusable.
- The materials that the product consist of should be durable.
- The materials that the product consist of should be advantageously recyclable.
- The materials that the product consist of should not contribute to unnecessary emissions in any steps of the product life cycle.

Compact living guidelines

These guidelines aims to help the company to develop products promoting compact living.

The products should be optimized

This guideline aims to optimize the product and take advantage of the user's lifestyle and behaviours when designing the products. This guideline also aims to design the products without any unnecessary material, technology or functions to make the product have a minimalistic design for a sustainable expression.

To work with this guideline, strive towards fulfilling the following statements:

- The products should take up less space when on display.
- The products should take up less space when stored.
- The product should be easy to move.
- Optimize material use.
- Optimize manufacturing.
- Optimize energy consumption

Examples:

- The products should be smaller to improve compact living and decrease material use.
- The products should benefit from each other's forms when standing close to each other in order to be space effective.
- The products could be combined into one but still function separately.
- The product should consist of as few components as possible.
- The product should only use the functions needed.
- The amount of electronics in the product should be decreased.

- The product should promote a simple manufacturing.
- No extra or unnecessary material should be used.
- The product form should use minimalistic features.
- The products should only use the amount of energy needed.
- Unnecessary heating of the product should be eliminated to save resources.

The products should be easy to store

This guideline aims to make the products easy to store when on display, in cabinets or drawers. When it comes to design the products should also be adjusted to small kitchens.

To work with this guideline, strive towards fulfilling the following statements:

- The product should fit into standard sized cabinets and/or drawers.
- The product itself should be designed to be movable.
- The products should not take up unnecessary space.

Examples:

- The cord should not make the products harder to store.

Recommendations for Electrolux

This chapter aims to give recommendations to Electrolux on how to work and what to focus on when working with Design for Sustainable Behaviour, Green branding and Compact living when assigning them to their products.

The company should analyse what level of sustainability they want to be connected to

This guideline aims to help the company define which level of sustainability they want to be connected to: Have greening as core, Have greening integrated in the core or Using green values and guaranties.

The user should be incorporated in the design phase

This guidelines aims to give the company recommendations on how to work with products in relation to the users to develop more user centred products.

Examples on how to work with this guideline:

- Try the product on users.
- Formulate the tests around everyday use, let the users use the products as they would have done at home.

The measurement system should be further developed

The measurement system was identified as a big contributor to waste creation in both kettle and coffee maker. Therefore a recommendation for the company is to work further with and investigate how the measurement system can be improved.

Examples on how to work with this guideline:

- Look at existing measurement systems and investigate why they do or do not work and incorporate that into the new design.
- Look at other products that makes people act in certain way to see how to best reach out to people when it comes to knowledge in the world, rules that everybody follows but that do not necessarily be outspoken.
- Tests should be made with users to see how they perceive different measuring systems.
- The designer should be aware of the user's habits around measuring water.

The company should work proactively with sustainability aspects

Sustainability will soon be something people take for granted and therefore it is desired to be in the forefront and to work proactive rather than reactive to take place on the market.

Examples on how to work with this guideline:

- Always strive for a constant development concerning sustainability aspects.
- Always be aware of how the competitors work with sustainability.
- Be aware of new technology that can be applied for a more sustainable behaviour.

The design should not be restricted to existing design features

This guideline aims to challenge stereotypes of what the products look like today. To create something innovative and fill the gap on the market for innovative and sustainable products the company should challenge their own designs.

Examples on how to work with this guideline:

- Understand what design features that are important for the product expression.
- Understand the product semantics.
- Explore what design features that can be challenged without losing the semantics of the product.
- Investigate the possibility of combining the product with other already existing products to make them more sustainable.

The dimensions of the products should be in line with standard kitchen dimensions

This guideline aims to follow existing standards for kitchens to not design products that do not fit into the context where they are used the most.

Examples on how to work with this guideline:

- Investigate standard dimension of kitchens today.
- Measure the product in its extreme modes, for example when lids are completely open to identify dimensions.
- Investigate how the users perceive the dimensions of the products.
- Investigate what dimensions of the products that the users expects.
- Investigate what dimensions of the products that go beyond user expectations.
- The designer should be aware of how the product is used.

